



Aastra Model 6753i IP Phone



User Guide

Release 3.2

41-001380-00 REV00 – 01.2011

Software License Agreement

Aastra Telecom Inc., hereinafter known as "Seller", grants to Customer a personal, worldwide, non-transferable, non-sublicenseable and non-exclusive, restricted use license to use Software in object form solely with the Equipment for which the Software was intended. This Product may integrate programs, licensed to Aastra by third party Suppliers, for distribution under the terms of this agreement. These programs are confidential and proprietary, and are protected as such by copyright law as unpublished works and by international treaties to the fullest extent under the applicable law of the jurisdiction of the Customer. In addition, these confidential and proprietary programs are works conforming to the requirements of Section 401 of title 17 of the United States Code. Customer shall not disclose to any third party such confidential and proprietary programs and information and shall not export licensed Software to any country except in accordance with United States Export laws and restrictions.

Customer agrees to not reverse engineer, decompile, disassemble or display Software furnished in object code form. Customer shall not modify, copy, reproduce, distribute, transcribe, translate or reduce to electronic medium or machine readable form or language, derive source code without the express written consent of the Seller and its Suppliers, or disseminate or otherwise disclose the Software to third parties. All Software furnished hereunder (whether or not part of firmware), including all copies thereof, are and shall remain the property of Seller and its Suppliers and are subject to the terms and conditions of this agreement. All rights reserved.

Customer's use of this software shall be deemed to reflect Customer's agreement to abide by the terms and conditions contained herein. Removal or modification of trademarks, copyright notices, logos, etc., or the use of Software on any Equipment other than that for which it is intended, or any other material breach of this Agreement, shall automatically terminate this license. If this Agreement is terminated for breach, Customer shall immediately discontinue use and destroy or return to Seller all licensed software and other confidential or proprietary information of Seller. In no event shall Seller or its suppliers or licensors be liable for any damages whatsoever (including without limitation, damages for loss of business profits, business interruption, loss of business information, other pecuniary loss, or consequential damages) arising out of the use of or inability to use the software, even if Seller has been advised of the possibility of such damages.

Table of Contents

Software License Agreement	ii
Table of Contents	iii
Welcome	1
About This Guide	1
Documentation	1
Phone Features	1
Requirements	2
Installation and Setup	2
Getting Started	3
Plugging in and Starting the Phone	3
Idle Screens	6
Incomplete Configuration	7
No Service	7
IP Phone Keys	8
Key Panel	8
Key Descriptions	10
Keypad Keys	12
Methods for Customizing Your Phone	13
Phone Options via the IP Phone UI	13
Phone Options via the Aastra Web UI	16
Phone Status	20
Phone Status via IP Phone UI	20
Finding Your Phone's IP Address	21
Phone Status via the Aastra Web UI	21
Customizing Your Phone	25
Ring Tone Sets	25
Contrast Level	28
Live Dialpad*	28
Set Audio	29
Time and Date	30
Language	34
User Password	43
Resetting a User Password	44
Restarting Your Phone	45

Table of Contents

Phone Lock	46
Defining an Emergency Dial Plan	47
Line Keys and Programmable Keys	49
Multiple Line and Call Appearance Keys	49
Programmable Keys	50
Line Key	53
Creating a Speed Dial Key	54
Editing Speed Dial Keys	60
Do Not Disturb (DND) Key	64
Busy Lamp Field (BLF) Key	65
BLF List Key	67
Flash Key	70
Automatic Call Distribution (ACD) Key (for Sylanro Servers)	71
Directed Call Pickup/Group Call Pickup Keys (for Sylanro Servers)	75
XML Key	79
Sprecode Key	82
Park/Pickup Keys	84
Last Call Return (lcr) Key (for Sylanro Servers)	86
Call Forward Key	87
BLF/Xfer	89
Speed Dial/Xfer	91
Speed Dial/Conf	93
Directory Key	95
Callers List Key	97
Transfer Key	99
Conference Key	100
Intercom Key	102
Services Key	104
Phone Lock Key	106
Paging Key (Sends the RTP Stream)	108
None Key	110
Deleting a Key	111
Making Calls	112
Dialing a Number	112

Table of Contents

Using Handsfree Speakerphone	112
Using a Headset	113
Redial	114
Mute	115
Receiving Calls	116
Answering an Incoming Call	116
Sending an Incoming Call to Voicemail	116
Handling Calls	117
Placing a Call on Hold	117
Transferring Calls	118
Conferencing Calls	121
Ending Calls	126
Managing Calls	127
Directory List	127
Callers List	137
Account Configuration (DND and Call Forwarding)	143
Missed Calls Indicator	163
Voicemail	164
Additional Features	165
Star Codes	165
Suppress DTMF Playback	166
Display DTMF Digits	167
Call Waiting Tone Period	169
Stuttered Dial Tone	170
XML Beep Support	171
Call Hold Reminder During Active Calls	172
Call Hold Reminder (on single hold)	174
Status Scroll Delay	176
Incoming Call Interrupts Dialing	177
Switch UI Focus to Ringing Line	179
Preferred Line and Preferred Line Timeout	180
Goodbye Key Cancels Incoming Calls	182
Message Waiting Indicator	183
Incoming Intercom Call Features	184

Table of Contents

Using Redial Key for “Last Number Redial”	187
Group RTP Paging (receives RTP streams)	188
Shared Call Appearance (SCA) Call Bridging	189
Available Features Enabled by Administrators	193
Outgoing Intercom Calls	193
Missed Call Summary Subscription	193
Customizable Callers List Key	194
Autodial (Hotline and Warmline)	194
Centralized Conferencing	195
Answer and Ignore Keys for XML Applications	195
Playing a WAV File On Your Phone	196
Using the Keypad During Active XML Applications	196
Key Redirection	197
XML Applications and Off-Hook Interaction	198
XML Override for a Locked Phone	198
RTP Recording and Simultaneous Playing	198
“Hold” Feature Enhancement (for Broadsoft Servers)	199
Configurable Save and Delete Keys	199
Authentication Support for HTTP/HTTPS Download Methods Used with Broadsoft Client Management System (CMS)	199
Diverting Calls from Your Phone	201
Display of Call Destination Information	202
Indication of Terminated Calls	203
Model M670i Expansion Module	205
Using the Expansion Module	206
Troubleshooting Solutions	207
Limited Warranty	212
Appendix A - Time Zone Codes	A-1
Index	Index-1

Welcome

The Aastra 6753i offers advanced XML capability to access custom applications and is fully interoperable with leading IP-PBX platforms. Featuring a 3-line display, the 6753i supports up to 9 lines with call appearances and allows you to make and receive calls, transfer, conference, and more. The 6753i IP telephone provides communications over an IP Network using the SIP IP telephony protocol.

About This Guide

This guide explains how to use the basic features of your new 6753i phone. Not all features listed are available by default. Contact your system or network Administrator to find out which features and services are available to you on your system.

Your System Administrator has the ability to customize some features on this phone. For information on more advanced settings and configurations, administrators should refer to the *Aastra Models 9000i and 6700i Series SIP IP Phones Administrator Guide*.

Documentation

- *Aastra 6753i SIP IP Phone Installation Guide* – Contains installation and set-up instructions, general features and functions, and basic options list customization. This Installation Guide is included in the box with your phone.
- *Aastra 6753i SIP IP Phone User Guide* – Describes the most commonly used features and functions for an end user.
- *Aastra Models 9000i and 6700i Series SIP IP Phones Administrator Guide* – Describes how to set the 6753i phone up on the network and contains advanced configuration instructions for the 6753i.

Phone Features

- 3-line LCD screen
- 6 top keys - all 6 keys are programmable
- Press-and-hold speed dial key configuration feature
- 3 call appearance lines with LEDs
- Supports up to 9 call lines
- Full-duplex speakerphone for handsfree calls

- Headset mode support (via handset jack)
- Built-in-two-port, 10/100/1000 Gigabit Ethernet switch - lets you share a connection with your computer.
- Inline power support (based on 802.3af standard) which eliminates power adapters
- AC power adapter (included)
- Enhanced busy lamp fields*
- Set paging*

*Availability of feature dependant on your phone system or service provider.

Requirements

The 6753i IP Phone requires the following environment:

- SIP-based IP PBX system or network installed and running with a SIP account created for the 6753i IP phone.
- Access to a Trivial File Transfer Protocol (TFTP), File Transfer Protocol (FTP), Hypertext Transfer Protocol (HTTP) server, or HyperText Transfer Protocol over Secure Sockets Layer (SSL) (HTTPS).
- Ethernet/Fast Ethernet LAN (10/100 Mbps) (Gigabit Ethernet LAN (1000 Mbps) recommended)
- Category 5/5e straight through cabling (category 6 straight through cabling required for optimum Gigabit Ethernet performance) Power source
 - For Ethernet networks that supply in-line power to the phone (IEEE 802.3af):
 - For power, use the Ethernet cable (supplied) to connect from the phone directly to the network for power. (No 48v AC power adapter required.)
 - For Ethernet networks that DO NOT supply power to the phone:
 - For power, use the 48V AC Power Adapter (included) to connect from the DC power port on the phone to a power source.
 - or
 - (optional) - For power, use a Power over Ethernet (PoE) power injector or a PoE switch. A PoE power injector is available as an optional accessory from Aastra Telecom. Contact your Administrator for more information.

Installation and Setup

If your System Administrator has not already setup your 6753i phone, please refer to the *Aastra 6753i Installation Guide* for basic installation and physical setup of the 6753i. For more advanced administration and configuration information, System Administrators should refer to the *Aastra Models 9000i and 6700i Series SIP IP Phones Administrator Guide*.

Getting Started

The 6753i must be set up and configured prior to its first use. This section describes phone behavior and start up screens you may see when the phone is first plugged in, or when it is restarted.

Plugging in and Starting the Phone

The 6753i automatically begins the start up sequence as soon as it is connected. The phone goes through this process the first time you plug in your phone and every time you restart your phone.



Note: Some start up screens only appear the first time you connect your phone, or if your phone has been factory defaulted.

The phone displays the following startup screens.



During the first start up the 6753i phone attempts to contact the Redirection and Configuration Server (rcs.aastra.com) for current server information. No personal information is transmitted from the phone during this process.



The 6753i phone may also look for configuration servers on your local network (press **3** *Remote* to enter a remote server address, or **4** *Skip* to continue without checking for servers).

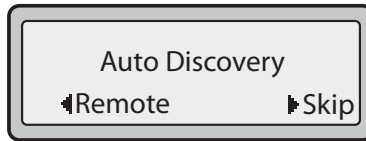

If appropriate servers are found they are listed for you to select from by scrolling down to view the complete list. (Press **3** *Skip* to continue without selecting a server.).

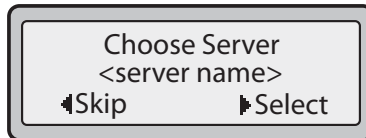

The 6753i phone then checks settings and looks for new configuration and firmware updates for the phone from a server. If a new update is found, the phone displays the message “*Updating Configuration*”. This may take a few moments while the phone downloads the latest updates

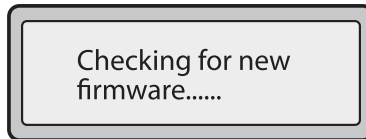
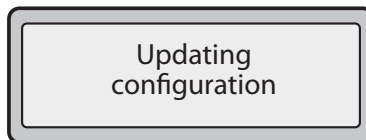

Note: New updates to your phone can be automatically scheduled from the server. This is set up on the phone system by your System Administrator and should be scheduled during non-business hours or slow call periods.



Important! Do not unplug or remove power to the phone while it is checking or installing firmware and configuration information.

If language packs were loaded to your phone by your System Administrator, the following screen displays during startup.

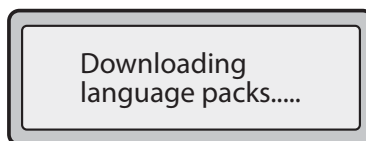

When the configuration update is complete, the phone displays the following screens.



Idle Screens

Idle Screen 1

When the phone has successfully updated the configuration and connected to the network, the phone displays the **Idle State** screen:

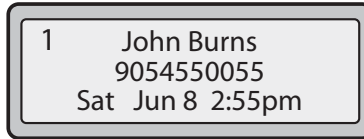

The **Idle State** screen lists your name (SIP screen name), extension (or phone number), and day, date, and time. The "1" in the upper corner in the above example indicates the idle screen for the first line appearance. You can use the left and right arrow keys to scroll through the idle screens for all three line appearances. The 6753i allows for scrolling up to 3 lines.

This screen is shown whenever your phone is not in use.

Idle Screen 2

The second display line displays the following temporary messages if the event occurs:

- No Service
- DHCP Failed
- Restarting.....
- New IP Obtained
- Network Disconnected/Connected



Note: Since the "Network Disconnected/Connected" display on two lines, the date and time does not show if this event displays.

The second line can also display the following status messages, listed in order of display priority:

- Call forward status
- DND On (Do Not Disturb)
- Number of missed calls

When more than one status message displays, the 2 is shown after the message to indicate you can use the 2 and 5 navigation keys to scroll through the remaining messages.

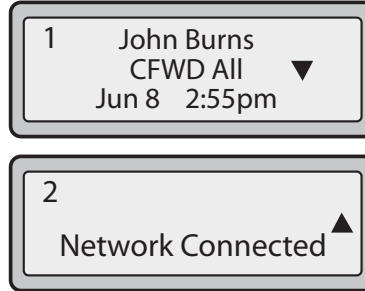

Incomplete Configuration

If your phone displays an "**Incomplete Config**" message without any extension or user name at the end of the start up sequence instead of an Idle state screen, this indicates the phone configuration that was downloaded from the configuration server is not complete or correct. Contact your System Administrator for assistance.

No Service

When the phone is not properly connected to the network, or the account has not been configured by the Network Administrator, the "**No Service**" or "**Network Disconnected**" prompt appears on the display and the telephone status light turns ON. The phone also displays the default time and date of 12:00am Jan. 1st, 2000. Check that the cables are tightly connected to the phone and to the wall jack. The phone should automatically detect when the connection is reconnected and display the "**Network Connected**" prompt temporarily.

If changes have been made to your phone settings, you may need to restart your phone. For more information on restarting your phone, see "[Restarting Your Phone](#)" on [page 45](#).

For more information about connecting your phone, refer to the *Aastra 6753i Installation Guide*. Check with your System Administrator for assistance.

IP Phone Keys

Key Panel



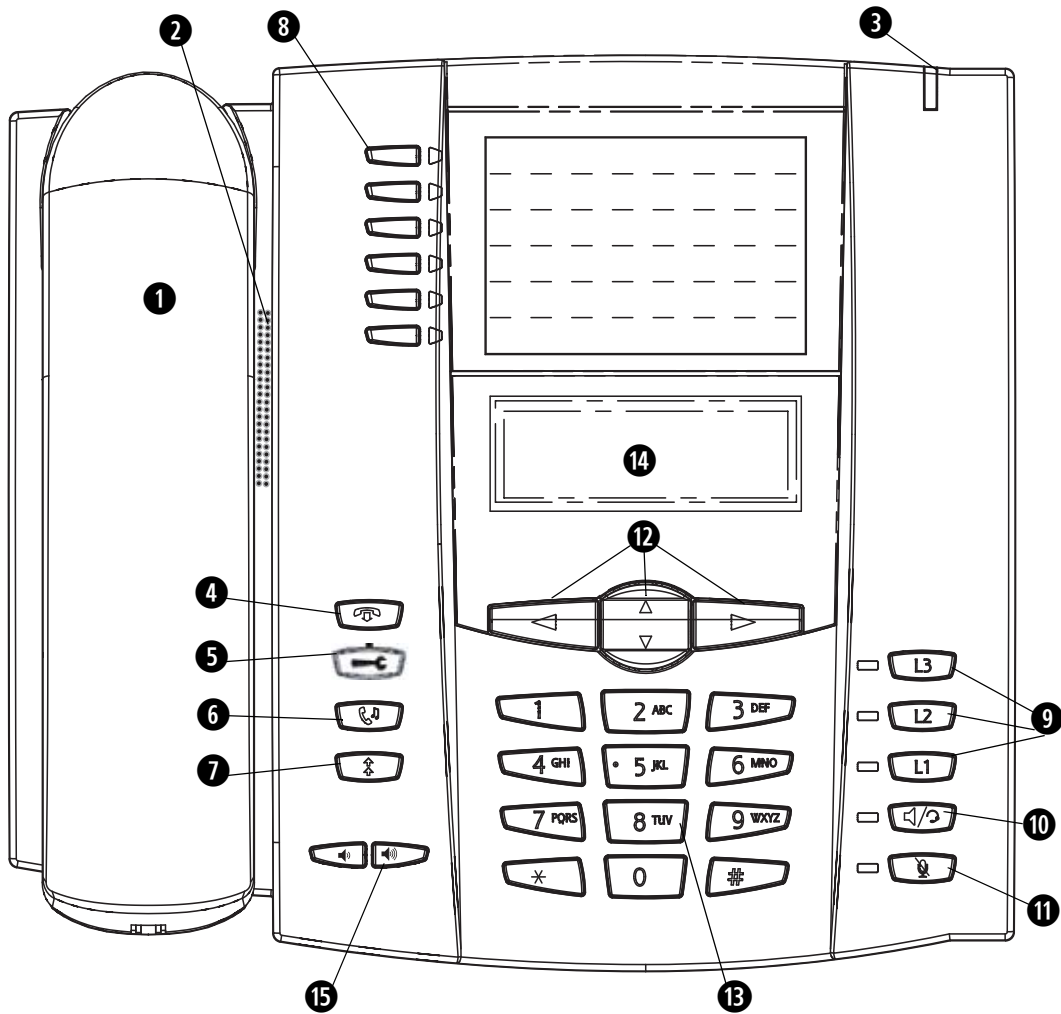













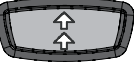

The following sections describe the various 6753i phone key functions on both the symbol and text hardware platforms, and how they help you make and manage your calls and caller information. Images of the symbol keys and the symbol hardware platform are used throughout this document.





1	6753i Handset	9	Three (3) Line Call
2	High Quality Speakerphone	10	Speakerphone/Headset Key
3	Message Waiting Lamp	11	Mute Key
4	Goodbye Key	12	Navigation Keys
5	Options Key	13	Keypad
6	Hold Key	14	LCD Screen
7	Redial Key	15	Volume Control (+) (-)
8	Softkeys		

Key Descriptions

The following table identifies the keys on the key panel of your 6753i IP phone that you can use for handling calls.

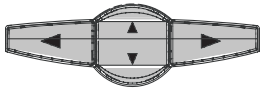
Text Keys	Symbol Keys	Key Description
		Goodbye key - Ends an active call. The Goodbye key also exits an open list, such as the Options List, without saving changes.
		Options key - Accesses options to customize your phone. Your System Administrator may have already customized some of your settings. Check with your System Administrator before changing the Administrator-only options.
		Hold key - Places an active call on hold. To retrieve a held call, press the call appearance button beside the light that is flashing.
		Redial key - Redials up to 100 previously dialed numbers. Pressing the Redial key twice simultaneously redials the last dialed number. ⁵³
		Volume control key - Adjusts the volume for the handset, headset, ringer, and handsfree speaker.
  	  	Line/Call Appearance key - Connects you to a line or call. The Aastra 6753i IP phone supports up to 3 line keys.
		Handsfree key - Activates Handsfree for making and receiving calls without lifting the handset. When the audio mode option is set, this key is used to switch between a headset and the handsfree speakerphone.
		Mute key - Mutes the microphone so that your caller cannot hear you (the light indicator flashes when the microphone is on mute).

Text Keys	Symbol Keys	Key Description
		<p>Navigation keys - Pressing the UP and DOWN arrow keys lets you view different status and text messages on the LCD display (if there is more than 1 line of status/text messages). These buttons also let you scroll through menu selections, such as the Options List.</p> <p>Pressing the LEFT and RIGHT arrow keys lets you view the different line/call appearances. While in the Options List, these keys allow you to exit or enter the current option. When you are editing entries on the display, pressing the LEFT arrow key erases the character on the left; pressing the RIGHT arrow key sets the option.</p>
		<p>Programmable keys - 6 Top Keys - all 6 keys are programmable.</p> <p>Keys 1 and 2 are designated as the SAVE and DELETE keys, respectively. Only your System Administrator can make these keys configurable, if required.</p> <p>The following are the default functions for the programmable keys on the 6753i IP phone:</p> <p>1 SAVE Allows you to save numbers and/or names to the Directory. Using this key, you enter the number, name, and line (or speed dial key) to record in the Directory List.</p> <p>2 DELETE Allows you to delete a single entry or all entries from the Directory List and Callers List.</p> <p>3 DIRECTORY Displays up to 200 names and phone numbers (stored in alphabetical order).</p> <p>4 CALLERS LIST Accesses the last 200 calls received.</p> <p>5 TRANSFER Transfers the active call to another number.</p> <p>6 CONFERENCE Begins a conference call with the active call.</p> <p>Notes:</p> <ol style="list-style-type: none"> For more information about the SAVE and DELETE keys, see “Configurable Save and Delete Keys” on page 199. For more information about configuring keys 1 thru 6 to perform specific functions, see “Programmable Keys” on page 50.

Keypad Keys

The 6753i has a keypad with digits from 0 through 9, a “*” key, and a “#” key. Keys 2 through 9 contain the letters of the alphabet. The 6753i phone keypad includes the following:

Keypad Key	Description
0	Dials 0 Dials the Operator on a registered phone
1	Dials 1
2 ABC	Dials 2 When entering text, this key enters A with one press, B with two presses, and C with three presses
3 DEF	Dials 3 When entering text, this key enters D with one press, E with two presses, and F with three presses
4 GHI	Dials 4 When entering text, this key enters G with one press, H with two presses, and I with three presses
5 JKL	Dials 5 When entering text, this key enters J with one press, K with two presses, and L with three presses
6 MNO	Dials 6 When entering text, this key enters M with one press, N with two presses, and O with three presses
7 P QRS	Dials 7 When entering text, this key enters P with one press, Q with two presses, R with three presses, and S with four presses.
8 TUV	Dials 8 When entering text, this key enters T with one press, U with two presses, and V with three presses
9 WXYZ	Dials 9 When entering text, this key enters W with one press, X with two presses, Y with three presses, and Z with four presses.

The “*” is called the “star key”. The “#” is called the “number sign”, “pound key”, or “hash key”, depending on one's nationality or personal preference. These can be used for special functions such as accessing voicemail. The “star key” and “pound key” functions are dependant on your country's feature availabilities. Contact your System Administrator for more information about available functions using these keys.

These keypad keys can be used for any of the following on the phone:

- Dial a phone number to make a call (see [“Dialing a Number”](#) on page 112.)
- Enter digits or letters in the IP Phone user interface.
- Program a speed dial number (see [“Creating a Speed Dial Key”](#) on page 54.)
- Press a speed dial key (see [“Creating a Speed Dial Key”](#) on page 54.)
- Press the keys associated with a called Interactive Voice Response (IVR) system.

Methods for Customizing Your Phone

There are two ways to customize specific options on your phone:

- Using the Options  key on the IP Phone
- Using the Aastra Web UI in an Internet browser window from your PC.

Phone Options via the IP Phone UI

You can customize your phone by pressing the Options  key and accessing the IP Phone UI.

These options allow you to customize the following phone settings.

Option Number	Option
1	Call Forward 1. Screenname 2. All Off 3. All On Note: The menus that display for Call Forward are dependant on the Call Forward Mode set on the phone. Default is "Account" mode.
2	Services 1. Directory 2. Callers List 3. Voicemail
3	Preferences 1. Tones Ring Tone Tone Set 2. Contrast Level 3. Speed Dial Edit 4. Live Dialpad 5. Set Audio Audio Mode Headset Mic Vol 6. Time and Date Time Zone Daylight Savings Time Format Date Format Time Server Time Server 1 Time Server 2 Time Server 3 Set Time Set Date 7. Language Screen Language Input Language

4	Phone Status 1. IP&MAC Addresses 2. LAN Port 3. PC Port 4. Firmware Info 5. Error Messages
5	User Password
6	Administrator Menu (Password Protected)
7	Restart Phone
8	Phone Lock



Note: *The "Administrator Menu" options are Administrator level functions only, and are not accessible by the user. These options should only be set up and changed by your System Administrator.

Simplified Options Menu



Your System Administrator may configure a simplified options menu for your phone. The following table indicates the options that may appear on your phone if the simplified options menu is applied.

Option Number	Option
1	Call Forward 1. Screenname 2. All Off 3. All On Note: The menus that display for Call Forward are dependant on the Call Forward Mode set on the phone. Default is "Account" mode.
2	Services 1. Directory 2. Callers List 3. Voicemail
2	Preferences 1. Tones Ring Tone Tone Set 2. Contrast Level 3. Live Dialpad 4. Set Audio Audio Mode Headset Mic Vol
3	Phone Status 1. IP&MAC Addresses 2. LAN Port 3. PC Port 4. Firmware Info 5. Error Messages
4	Phone Lock

Using the IP Phone UI



IP Phone UI

1. Press the Options key  on the phone to enter the Options List.
2. Use 2 and 5 to scroll through the list of options, or press the number corresponding to the **Option**.
3. Press **Enter**, the 4 key, or press the digit number of the corresponding option to select an option.
4. Change a selected option if applicable.
5. Press the **Set** or **Done** key to save the change.
6. Press the  button, the 3 key, or the  button at any time to exit without saving changes.

Reference

For more information about customizing your phone using the available options from the IP Phone UI, see the section [“Customizing Your Phone”](#) on [page 25](#).

For more information about Administrator options, contact your System Administrator.

Phone Options via the Aastra Web UI

In addition to the IP Phone UI options, you can customize additional options on the IP Phone using the Aastra Web UI. In order to access your phone using the Aastra Web UI, you need to know your phone's IP address. To find your phone's IP address, see [“Finding Your Phone's IP Address”](#) on page 21.

Using the Aastra Web UI



Aastra Web UI

1. Open your web browser, enter the phone's IP address or host name into the address field and press **<Enter>**.

The following logon screen displays.



2. At the prompt, enter your username and password and click **OK**.



Note: For a user, the default user name is **“user”** and the password field is left blank.

The Network Status window displays for the IP phone you are accessing.

AASTRA 6753i
Log Off

Status
System Information

Operation
User Password
Phone Lock
Programmable Keys
Keypad Speed Dial
Directory
Reset

Basic Settings
Preferences
Account Configuration

Network Status

Attribute	LAN Port	PC Port
Link State	Up	Down
Negotiation	Auto	Auto
Speed	100Mbps	10Mbps
Duplex	Full	Half

MAC Address: 00-08-5D-16-11-34

Hardware Information

Attribute	Value
Platform	53i Revision 0

Firmware Information

Attribute	Value
Firmware Version	2.5.0.83
Firmware Release Code	SIP
Boot Version	2.3.0.1217
Date/Time	Feb 9 2008 02:07:51

SIP Status

Line	SIP Account	Status	Backup Registrar Used?
1	9995551212@proxy.com:5060	Registered	Yes
2	9995551212@proxy.com:5060	Registered	Yes
3	9995551212@proxy.com:5060	Registered	Yes

3. You can log out of the Aastra Web UI at any time by clicking **Log Off**.

The following categories display in the side menu of the Aastra Web UI: **Status, Operation, Basic Settings.**

Headings	Descriptions
Status	The Status section displays the network status and the MAC address of the IP phone. It also displays hardware and firmware information about the IP phone, and information about the SIP account(s) currently configured on the phone. The information in the Network Status window is read-only.
Operation	<p>User Password - Allows you to change user password.</p> <p>Phone Lock - Allows you to assign an emergency dial plan to the phone, lock the phone to prevent any changes to the phone and to prevent use of the phone, and reset the user password.</p> <p>Programmable Keys - There are 6 function keys, all 6 of which you can configure to perform the functions identified in the following list.</p> <p>Your Administrator must unlock the SAVE and DELETE keys in order for these keys to be configurable. For more information about the SAVE and DELETE keys, see “Configurable Save and Delete Keys” on page 199.</p> <ul style="list-style-type: none"> • None • Line • Speed Dial • Do Not Disturb (DND) • Busy Lamp Field (BLF) • BLF List • Auto Call Distribution (ACD) • Directed Call Pickup • Extensible Markup Language (XML) • Flash • Sprecode • Park • Pickup • Last Call Return (lcr) • Call Forward • BLF/Xfer • Speed Dial/Xfer • Speed Dial/Conf • Directory • Callers List • Conference • Transfer • Incom (Intercom) • Services • Phone Lock • Paging <p>Keypad Speed Dial - Allows you to assign a speed dial number to a specific digit on the phone’s keypad for speed dialing purposes.</p> <p>Expansion Module - Allows you to configure an additional 36 keys with a M670i Expansion Module if it is attached to the phone. This option displays on the side menu of the Aastra Web UI only if an Expansion Module is attached.</p> <p>Directory - Allows you to copy the Callers List and Directory List from your IP phone to your PC.</p> <p>Reset - Allows you to restart the IP phone when required.</p>

Headings	Descriptions
Basic Settings	<p>Preferences - Allows you to enable/disable the following:</p> <ul style="list-style-type: none"> • Suppress DTMF Playback • Display DTMF Digits • Play Call Waiting Tone • Stuttered Dial Tone • XML Beep Support • Status Scroll Delay (seconds) • Incoming Call Interrupts Dialing • Switch UI Focus to Ringing Line • Call Hold Reminder During Active Calls • Call Hold Reminder • Call Waiting Tone Period • Preferred Line • Preferred Line Timeout (seconds) • Goodbye Key Cancels Incoming Call • Message Waiting Indicator Line • DND Key Mode • Call Forward Key Mode <p>This category also allows you to configure:</p> <ul style="list-style-type: none"> • Incoming Intercom Call Settings • Group Paging RTP Settings • Ring Tones (global and per-line basis) • Time and Date Settings • Webpage Language and Language Settings <p>Account Configuration - Allows you to configure “do not disturb” (DND) and “call forwarding” (CFWD) by account. You can have multiple accounts on the 6753i.</p>

Phone Status

You can view the status of your phone using the IP Phone UI or the Aastra Web UI.

Phone Status via IP Phone UI

The "**Phone Status**" option on the IP phone displays the status of your phone to the LCD display.

This option allows you to view your phone's:

- Network status including your phone's IP and MAC address
- Local Area Network (LAN) port information
- PC Port information (if PC link exists)
- Firmware version
- Error messages from the last reboot or startup

Use the following procedure to view the status of your phone using the IP Phone UI.



IP Phone UI

1. Press  on the phone to enter the Options List.
2. Select **Phone Status**.
3. Select the option you want to view:
 - **IP&MAC Address**
 - **LAN Port**
 - **PC Port**
 - **Firmware Info**
 - **Error Messages**

The option you select displays to the LCD. Use the ▲ and ▼ keys to scroll through the LCD display.

Finding Your Phone's IP Address

If you want to access your phone's options using an Internet browser, you need to enter the IP address of the phone in the browser to open the Aastra Web UI. Use the following procedure to find your phone's IP address.

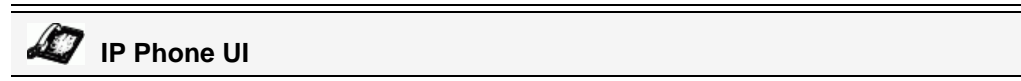

1. Press the  button on the phone to enter the Option List.
2. Select **Phone Status** and press the 4 key.

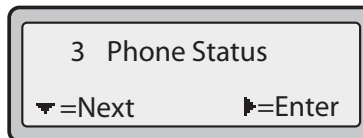

3. Select "**IP&MAC Addresses**" and press the 4 key.

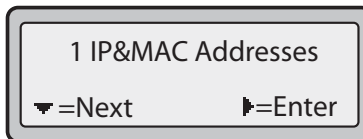

The IP address of your 6753i IP phone displays in the "**IP Address**" field.

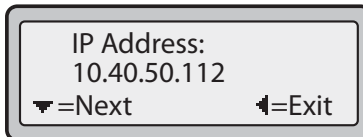

Phone Status via the Aastra Web UI

Use the following procedure to view the phone status via the Aastra Web UI.



1. Open your web browser, enter the phone's IP address or host name into the address field and press <Enter>.
2. In the Username/Password window, enter your username and password and click **OK**.



Note: For a user, the default user name is "user" and the password field is left blank.

The Network Status window displays for the IP phone you are accessing.

AASTRA 6753i
Log Off

Status
System Information
Operation
User Password
Phone Lock
Programmable Keys
Keypad Speed Dial
Directory
Reset
Basic Settings
Preferences
Account Configuration

Network Status

Attribute	LAN Port	PC Port
Link State	Up	Down
Negotiation	Auto	Auto
Speed	100Mbps	10Mbps
Duplex	Full	Half

MAC Address: 00-08-5D-16-11-34

Hardware Information

Attribute	Value
Platform	53i Revision 0

Firmware Information

Attribute	Value
Firmware Version	2.5_0.83
Firmware Release Code	SIP
Boot Version	2.3_0.1217
Date/Time	Feb 9 2008 02:07:51

SIP Status

Line	SIP Account	Status	Backup Registrar Used?
1	9995551212@proxy.com:5060	Registered	Yes
2	9995551212@proxy.com:5060	Registered	Yes
3	9995551212@proxy.com:5060	Registered	Yes

This Network Status window is view only. It displays the Network Status of your phone which includes the following:

- Link State, Negotiation, Speed, and Duplex setting for the LAN and PC ports
- MAC Address
- Hardware Information
- Firmware Information
- SIP Account status

SIP Account Status

The IP Phones show the SIP registration status on the IP Phone's Network Status screen in the Aastra Web UI.

The following is an illustration of the Network Status screen in the Aastra Web UI with SIP status displayed.

AASTRA 6753i
Log Off

Status
System Information
Operation
User Password
Phone Lock
Programmable Keys
Keypad Speed Dial
Directory
Reset
Basic Settings
Preferences
Account Configuration

Network Status

Attribute	LAN Port	PC Port
Link State	Up	Down
Negotiation	Auto	Auto
Speed	100Mbps	10Mbps
Duplex	Full	Half

MAC Address: 00-08-5D-16-11-34

Hardware Information

Attribute	Value
Platform	53i Revision 0

Firmware Information

Attribute	Value
Firmware Version	2.5.0.83
Firmware Release Code	SIP
Boot Version	2.3.0.1217
Date/Time	Feb 9 2008 02:07:51

SIP Status

Line	SIP Account	Status	Backup Registrar Used?
1	9995551212@proxy.com:5060	Registered	Yes
2	9995551212@proxy.com:5060	Registered	Yes
3	9995551212@proxy.com:5060	Registered	Yes

SIP Account Status

The following table describes the status conditions that can display for the account.

Status Condition	Description								
Registered	<p>Displays this status on accounts that HAVE been registered with the SIP proxy server.</p> <p>Example:</p> <p>Backup</p> <p>Registrar</p> <table border="1" data-bbox="565 554 1416 613"> <thead> <tr> <th>Line</th> <th>SIP Account</th> <th>Status</th> <th>Used?</th> </tr> </thead> <tbody> <tr> <td>1</td> <td>9057604603@anasiproxy.aastra.com:5060</td> <td>Registered</td> <td>Yes</td> </tr> </tbody> </table> <p>where Account Number is "1" SIP Account is "9057604603@anasiproxy.aastra.com" on port "5060" Status is "Registered" Backup registrar is used ("Yes")</p>	Line	SIP Account	Status	Used?	1	9057604603@anasiproxy.aastra.com:5060	Registered	Yes
Line	SIP Account	Status	Used?						
1	9057604603@anasiproxy.aastra.com:5060	Registered	Yes						
SIP Error Number	<p>Displays on accounts when registration fails with the SIP proxy server.</p> <p>Example:</p> <p>Backup</p> <p>Registrar</p> <table border="1" data-bbox="565 1003 1416 1062"> <thead> <tr> <th>Line</th> <th>SIP Account</th> <th>Status</th> <th>Used?</th> </tr> </thead> <tbody> <tr> <td>4</td> <td>9057604601@anasiproxy.aastra.com:5060</td> <td>401</td> <td>No</td> </tr> </tbody> </table> <p>where Account Number is "4" SIP Account is "9057604601@anasiproxy.aastra.com" on port "5060" Status is "401" - Unregistered if SIP registration fails. Backup registrar is used ("No")</p>	Line	SIP Account	Status	Used?	4	9057604601@anasiproxy.aastra.com:5060	401	No
Line	SIP Account	Status	Used?						
4	9057604601@anasiproxy.aastra.com:5060	401	No						

Customizing Your Phone

The following paragraphs describe the options available from either the IP Phone UI, the Aastra Web UI, or both, and provide procedures applicable to the option.

Ring Tone Sets

You can configure ring tones and ring tone sets on the IP phone.

Ring Tones

There are several distinct ring tones a user can select from to set on the IP phones. You can enable/disable these ring tones on a global or per-line basis.

The following table identifies the valid settings and default values for each type of configuration method.

Ring Tones Table

Configuration Method	Valid Values	Default Value
IP Phone UI	Global Tone 1 Tone 2 Tone 3 Tone 4 Tone 5 Silent	Global Setting: Tone 1
Aastra Web UI	Global: Tone 1 Tone 2 Tone 3 Tone 4 Tone 5 Silent	Global Setting: Tone 1
Lines 1 to 9	Per-Line Setting: Global Tone 1 Tone 2 Tone 3 Tone 4 Tone 5 Silent	Per-Line Setting: Global

Ring Tone Sets

In addition to ring tones, you can configure ring tone sets on a global-basis on the IP phone. Ring tone sets consist of tones customized for a specific country. The ring tone sets you can configure on the IP phones are:

- United States (US) (Default - also used in Canada)
- Mexico
- Malaysia
- Brazil
- United Kingdom (UK)
- Italy
- Germany
- France
- Europe (generic tones)
- Australia
- Russia

When you configure the country's tone set, the country-specific tone is heard on the phone for the following:

- dial tone
- secondary dial tone
- ring tone
- busy tone
- congestion tones
- call waiting tone
- ring cadence pattern

You configure global ring tones and tone sets using the Aastra Web UI and the IP Phone UI.

Configuring Ring Tones and Tone Sets



IP Phone UI

Use the following procedures to configure ring tones and tone sets on the IP phone.

Global configuration only

1. Press  on the phone to enter the Options List.
2. Select **Preferences**.

3. Select **Tones**.
4. Select **Ring Tone**.
5. Select the type of ring tone (**Tone 1** through **Tone 5**, or **Silent**).
6. Select **Set** and then press 2.
7. Select **Tone Set**.
8. Select the country for which you want to apply the tone set. Valid values are **Australia, Europe, France, Germany, Italy, UK, Mexico, Brazil, Malaysia, Russia**, and **US**. Default is **US**.
9. Press 4.
The ring tone and tone set you select is immediately applied to the IP phone.



Aastra Web UI

1. Click on **Basic Settings->Preferences->Ring Tones**.

Ring Tones	
Tone Set	US
Global Ring Tone	Tone 4
Line 1	Global
Line 2	Global
Line 3	Global
Line 4	Global
Line 5	Global
Line 6	Global

For global configuration:

2. In the "**Ring Tones**" section, select a country from the "**Tone Set**" field.
Valid values are **Australia, Europe, France, Germany, Italy, UK, Mexico, Brazil, Malaysia, Russia**, and **US**. Default is **US**.
3. Select a value from the "**Global Ring Tone**" field.



Note: *See the [Ring Tones Table](#) on [page 25](#) for valid values.

For per-line configuration:

4. In the "**Ring Tone**" section, select a line for which you want to set ring tone.
5. Select a value from the "**LineN**" field.



Note: See the [Ring Tones Table](#) on [page 25](#) for valid values.

6. Click **Save Settings**.

Contrast Level

The "**Contrast Level**" option on the IP phone allows you to set the amount of light that illuminates the LCD display. Use this option to set the preference of contrast level.

You can set the contrast level using the IP Phone UI only.

Setting Contrast Level



IP Phone UI

1. Press  on the phone to enter the Options List.
2. Select **Preferences**.
3. Select **Contrast Level**.
4. Use the 3 and 4 navigation buttons to increase or decrease the intensity of contrast lighting on the LCD.
5. Press **Set** to save your selection.

Live Dialpad*

The "**Live Dialpad**" option on the IP phone turns the Live Dial Pad mode ON or OFF. With live dial pad ON, the 6753i IP phone automatically dials out and turns ON Handsfree mode as soon as a dial pad key or programmable key is pressed. With live dial pad OFF, if you dial a number while the phone is on-hook, lifting the receiver or pressing the  initiates a call to that number.

*Availability of feature dependant on your phone system or service provider.

You can enable/disable the live dialpad using the IP Phone UI only.

Enabling/Disabling Live Dialpad



IP Phone UI

1. Press  on the phone to enter the Options List.
2. Select **Preferences**.
3. Select **Live Dialpad**.
4. Use the **Change** key to turn the live dialpad ON or OFF.
5. Press **Done** to save your selection.





Set Audio

The "Set Audio" option on the IP Phone allows you to set the audio mode for your IP phone. It also allows you to set the volume level of the headset microphone.

You can set Audio on your IP phone using the IP Phone UI only.

Audio Mode

The 6753i allows you to use a handset, a headset, or handsfree mode to handle incoming and outgoing calls. The audio mode option provides different combinations of these three methods to provide maximum flexibility in handling calls. There are four audio mode options you can set:

Audio Mode Option	Description
Speaker	This is the default setting. Calls can be made or received using the handset or handsfree speakerphone. In handset audio mode, pressing the  button on the phone switches to handsfree speakerphone. In Speaker audio mode, lift the handset to switch to the handset.
Headset	Choose this setting if you want to make or receive all calls using a headset or handset. Calls can be switched from the handset to headset by pressing the  button on the phone. To switch from the headset to the handset, lift the handset.
Speaker/Headset	Incoming calls are sent to the handsfree speakerphone first when the  button is pressed. By pressing the button again, you can switch back and forth between the handsfree speakerphone and the headset. At anytime, lifting the handset switches back to the handset from either the handsfree speakerphone or the headset.
Headset/Speaker	Incoming calls are sent to the headset first when the  button is pressed. By pressing the button again, you can switch back and forth between the headset and the handsfree speakerphone. At anytime, lifting the handset switches back to the handset from either the headset or the handsfree speakerphone.

Headset Mic Volume

The "Headset Mic Volume" option allows you to set the volume level for the headset microphone.

Setting Audio Mode and Headset Mic Volume



1. Press  on the phone to enter the Options List.
2. Select **Preferences**.
3. Select **Set Audio**.
4. Select **Audio Mode**.

5. Select the audio mode you want to use on your phone. Valid values are:
Speaker
Headset
Speaker/Headset
Headset/Speaker
6. Press **Done** to save your selection.
7. Select **Headset Mic Volume**.
8. Select the **Low**, **Medium**, or **High** volume level.
9. Press **Done** to save your selection.

Time and Date

On the IP phones, you can configure the following:

- Time and date
- Time and date format
- Time zone
- Daylight savings time
- Time Servers



Note: Only the Time and Date Formats and Time Servers can be set using the Aastra Web UI.
Note:

Configuring Time and Date

Use the following procedures to configure the time and date settings on the IP phone.



IP Phone UI

Set Time and Time Format

1. Press  on the phone to enter the Options List.
2. Select **Preferences**.
3. Select **Time and Date**.
4. Select **Set Time**.
5. Using the keys on the keypad, enter a time to set on the IP phone. Use the **3** and **4** navigation keys to move backward or forward when entering the time. Use the **"*"** key to set either AM or PM.
6. Press **Set** to save the time setting.
7. Select **Time Format**.

8. Using the "**Change**" key, set the Time Format to either a 12 hour format or a 24 hour format. Valid values are **12h** and **24h**. Default is **12h**.
9. Press **Set** to save the Time Format you selected.

Set Date and Date Format

1. Select **Preferences**.
2. Select **Time and Date**.
3. Select **Set Date**.
4. Using the keys on the keypad, enter a date to set on the IP phone. Use the **3** and **4** navigation keys to move backward or forward when entering the date.
5. Press **Set** to save the date setting.
6. Select **Date Format**.
7. Select a date format from the list of options. Default is **Sun Jan 2**. Valid values are:
 - Sun Jan 2 (Default)
 - 2-Jan-00
 - 2000 01 02
 - 02/01/2000
 - 02/01/00
 - 02-01-00
 - 01/.02/00
 - Jan 2
 - 2 Jan 2000
 - Sun 2 Jan
 - 2 Jan
 - 02.01.2000
8. Press **Set** to save the Date Format setting.

Set Time Zone

1. Select **Preferences**.
2. Select **Time and Date**.
3. Select **Time Zone**.
4. Press ***** to display a list of Time Zone options.
A list of Time Zones display for different areas of the world.
5. Select a Time Zone that applies to your area.
The default Time Zone is **US-Eastern**.



Note: For a list of the Time Zones values available on the IP Phone, see [‘Appendix A - Time Zone Codes.’](#)

6. Press **Set** to save the Time Zone setting.

Set Daylight Savings Time

1. Select **Preferences**.
2. Select **Time and Date**.
3. Select **Daylight Savings**.
4. Select a Daylight Savings time from the list of options.
Valid values are:
 - **OFF**
 - **30 min summertime**
 - **1 h summertime**
 - **Automatic (Default)**



Note: The default for Daylight Savings is **Automatic**.

5. Press **Set** to save the Daylight Savings setting.

Set Time Servers

With a valid time server enabled your IP phone will synchronize the time displayed with the specified configuration server. The phone will use the time from Time Server 1 unless it is not configured or unavailable, in which case it will move on to Time Server 2, and if necessary Time Server 3.

1. Select **Preferences**.
2. Select **Time and Date**.
3. Select **Time Server**.
4. Select from **Time Server 1**, **Time Server 2**, or **Time Server 3**.
5. Enter an IP address or domain name for the time server.



Note: The default for Time Servers is **Enabled**. The Time Servers can be Enabled or Disabled only from the Aastra Web UI.

6. Press **Set** to save the time server setting.



1. Click on **Basic Settings->Preferences->Time and Date Setting.**

Time and Date Setting	
Time Format	24h
Date Format	DD/MM/YYYY
NTP Time Servers	<input checked="" type="checkbox"/> Enabled
Time Server 1	128.100.102.201
Time Server 2	
Time Server 3	

2. In the “**Time Format**” field, select the time format you want to use on your phone. Valid values are:

- **12h** (12 hour format) (default)
- **24h** (24 hour format)



Note: The time and time format you configure display on the phone’s idle screen.

3. In the “**Date Format**” field, select the date format you want to use on your phone. Default is **WWW MMM DD**. Valid values are:

- WWW MMM DD (default)
- DD-MMM-YY
- YYYY-MM-DD
- DD/MM/YYYY
- DD/MM/YY
- DD-MM-YY
- MM/DD/YY
- MMM DD
- DD MMM YYYY
- WWW DD MMM
- DD MMM
- DD.MM.YYYY



Note: The date and date format you configure display on the phone’s idle screen.

4. In the “**NTP Time Servers**” field, enable by checking the checkbox or disable by unchecking the box (default is enabled).

5. In the “**Time Server 1**”, “**Time Server 2**”, and “**Time Server 3**” fields, enter IP addresses or qualified domain names for the primary, secondary, and tertiary time servers.



Note: Time Servers can only be entered if NTP Time Servers is enabled.

6. Click **Save Settings**.

Language

The IP phones support several different languages. You can have the IP Phone UI and the Aastra Web UI display in a specific language as required. When you set the language to use, all of the display screens (menus, services, options, configuration parameters, etc.) display in that language. The IP phones support the following languages:

- English (default)
- French (Canadian)
- French (European)
- Spanish (Mexican)
- Spanish (European)
- German
- Italian
- Portuguese
- Russian
- Nordic

You can also configure the language to use when inputting values in the Aastra Web UI and the IP Phone UI.

Specifying the Language to Use

Once the language pack(s) are available on your phone from your System Administrator, you can specify which language to use on the phone and/or the Aastra Web UI.



Note: All languages may not be available for selection. The available languages are dependant on the language packs currently loaded to the IP phone.



IP Phone UI

Use the following procedure to specify which language to use for the IP Phone UI.

1. Press  on the phone to enter the **Options List**.
2. Select **Preferences**.
3. Select **Language**.

4. Select **Screen Language**.

The language setting displays a check mark indicating this is the current language on the IP Phone.

5. Using the 2 and 5 keys, scroll through the languages. Valid values are:

- **English** (default)
- **Français** (French)
- **Español** (Spanish)
- **Deutsch** (German)
- **Italiano** (Italian)
- **Português** (Portuguese)
- **Русский** (Russian)
- **Nordic**



Note: All languages may not be available for selection. The available languages are dependant on the language packs currently loaded to the IP phone. English is the default language and cannot be changed or removed. For more information about loading language packs, see your System Administrator.

6. Press **Set** to set the language on the phone.

The change is dynamic. When you exit the Options Menu, the phone displays all menu items in the language you selected.



Note: You must have the language pack(s) already loaded to your phone in order to use them. For more information about loading language packs, see your System Administrator.

1. Click on **Basic Settings->Preferences->Language Settings.**

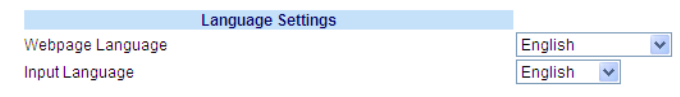

2. In the “**Webpage Language**” field, select a language to apply to the Aastra Web UI. The IP phone supports the following languages:

- **English** (default)
- **Français** (French)
- **Español** (Spanish)
- **Deutsch** (German)
- **Italiano** (Italian)
- **Português** (Portuguese)
- **Русский** (Russian)
- **Nordic**



Note: All languages may not be available for selection. The available languages are dependant on the language packs currently loaded to the IP phone by your System Administrator. English is the default language and cannot be changed or removed.

3. Click **Save Settings**. The change is dynamic. The Aastra Web UI displays all screens in the language you selected.

Language Input

The 6753i supports text and character inputs in various languages (English, German, French, Spanish, and Italian, Portuguese, and Russian). Inputting textual or character information into the IP Phone UI can be done using the keypad on the phone. You enable the Language Input feature using the Aastra Web UI or the IP Phone UI. You can then use text and characters in a specific language when performing inputs on the phone.

The following tables identify the language characters that you can use to enter text and characters on the 6753i.

Keypad Input Alphabet Tables

English

Key	Uppercase Characters	Lowercase Characters
0	0	0
1	1.;=,-'&()	1.;=,-'&()
2	ABC2	abc2
3	DEF3	def3
4	GHI4	ghi4
5	JKL5	jkl5
6	MNO6	mno6
7	PQRS7	pqrs7
8	TUV8	tuv8
9	WXYZ9	wxyz9
*	* <SPACE>	* <SPACE>
#	#\@	#\@

French

Key	Uppercase Characters	Lowercase Characters
0	0	0
1	1.;=,-'&()	1.;=,-'&()
2	ABC2ÂÂÇÁÀÆ	abc2ââçáàæ
3	DEF3ÉÉÊË	def3ééêë
4	GHI4Ï	ghi4ï
5	JKL5	jkl5
6	MNO6ÑÓÔÕ	mno6ñóôõ
7	PQRS7	pqrs7
8	TUV8ÚÛÜ	tuv8úûü
9	WXYZ9	wxyz9
*	* <SPACE>	* <SPACE>
#	#\@	#\@

Spanish

Key	Uppercase Characters	Lowercase Characters
0	0	0
1	1.;=,_'&()	1.;=,_'&()
2	ABC2ÁÂÇ	abc2áâç
3	DEF3ÉÊ	def3éè
4	GHI4Í	ghi4í
5	JKL5	jkl5
6	MNO6ÑÓÒ	mno6ñóò
7	PQRS7	pqrs7
8	TUV8ÚÛ	tuv8úü
9	WXYZ9	wxyz9
*	* <SPACE>	* <SPACE>
#	#^@	#^@

German

Key	Uppercase Characters	Lowercase Characters
0	0	0
1	1.;=,_'&()	1.;=,_'&()
2	ABC2ÄÅ	abc2äå
3	DEF3Ë	def3é
4	GHI4	ghi4
5	JKL5	jkl5
6	MNO6Ö	mno6ö
7	PQRS7ß	pqrs7ß
8	TUV8Û	tuv8ü
9	WXYZ9	wxyz9
*	* <SPACE>	* <SPACE>
#	#^@	#^@

Italian

Key	Uppercase Characters	Lowercase Characters
0	0	0
1	1.;=,_'&()	1.;=,_'&()
2	ABC2ÀĀÇ	abc2àâç
3	DEF3ÉĒĒ	def3éèè
4	GHI4	ghi4
5	JKL5	jkl5
6	MNO6ÓÒ	mno6óò
7	PQRS7	pqrs7
8	TUV8Û	tuv8ù
9	WXYZ9	wxyz9
*	* <SPACE>	* <SPACE>
#	#\@	#\@

Portuguese

Key	Uppercase Characters	Lowercase Characters
0	0	0
1	1.;=,_'&()	1.;=,_'&()
2	ABC2ÁÀÃÄÅÇ	abc2áâãäåç
3	DEF3ÉÊ	def3éê
4	GHI4Í	ghi4í
5	JKL5	jkl5
6	MNO6ÓÔÕ	mno6óôõ
7	PQRS7	pqrs7
8	TUV8ÚÛ	tuv8úü
9	WXYZ9	wxyz9
*	* <SPACE>	* <SPACE>
#	# / \ @	# / \ @

Russian

Key	Uppercase Characters	Lowercase Characters
0	0	0
1	1.;=,_'&()	1.;=,_'&()
2	АБВГ2ABC	абвг2abc
3	ДЕЁЖЭЗDEF	Деёжэзdef
4	ИЙКЛ4GHI	ийкл4ghi
5	МНОП5JKL	мноп5jkl
6	РСТУ6MNO	рсту6mno
7	ФХЦЧ7PQRS7	фхчч7pqrs
8	ШЩЪЫ8TUV	шщъы8tuv
9	ЪЗЮЯ9WXYZ	ъзюя9wxyz
*	* <SPACE>	* <SPACE>
#	#^@	#^@

Configuring Language Input Using the IP Phone UI

You can configure the language you use for inputting on the phone by setting the **Input Language** option. The default input language setting is English. You can change this setting using the IP Phone UI or the Aastra Web UI.

Example

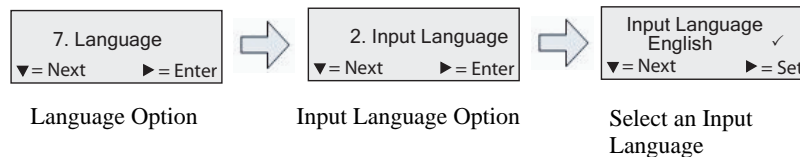

IP Phone UI

Use the following procedure to change the input language using the IP Phone UI.

1. Press  on the phone to enter the **Options List**.
2. Select **Preferences**.
3. Select **Language**.
4. Select **Input Language**.
Select the language you want to use when inputting text and characters into the IP Phone UI.
Valid values are:

- **English** (default)
- **Français** (French)
- **Español** (Spanish)
- **Deutsch** (German)
- **Italiano** (Italian)
- **Português** (Portuguese)
- **Русский** (Russian)



Note: Available input languages are dependent on the configuration enabled by your System Administrator.

5. Press **Set** when you have selected an input language.



Aastra Web UI

Use the following procedure to set the input language using the Aastra Web UI.

1. Click on **Basic Settings-> Preferences->Language Settings**.

Language Settings	
Webpage Language	English
Input Language	English

2. Select a language from the "**Input Language**" field. Setting this field allows you to specify the language to use when entering text and characters in the Aastra Web UI and IP Phone UI. Valid values are:

- **English** (default)
- **Français** (French)
- **Español** (Spanish)
- **Deutsch** (German)
- **Italiano** (Italian)
- **Português** (Portuguese)
- **Русский** (Russian)



Note: All languages may not be available for selection. The available input languages are dependant on the configuration enabled by your System Administrator.

3. Click **Save Settings**. The change is dynamic. The Aastra Web UI and IP Phone UI allow you to enter text and characters in the language you selected.

Latin 2 Character Set

The 6753i includes support for ISO 8859-2 (Latin2) of multi-national languages when displaying and inputing in the IP Phone UI and the Aastra Web UI.

UTF-8 is also compatible with XML encoding on the IP Phones.

The following table illustrates the Latin 2 character set used on the 6753i IP Phone.

	-0	-1	-2	-3	-4	-5	-6	-7	-8	-9	-A	-B	-C	-D	-E	-F
A-	NBSP 00A0 160	À 0104 161	Á 02D8 162	Â 0141 163	Ã 00A4 164	Ä 013D 165	Å 015A 166	Æ 00A7 167	Ç 00A8 168	Š 0160 169	Ş 015E 170	Ť 0164 171	Ž 0179 172	SHY 00AD 173	Ž 017D 174	Ž 017B 175
B-	° 00B0 176	ą 0105 177	ć 02DB 178	ł 0142 179	ł 00B4 180	ś 013E 181	ş 015B 182	ş 02C7 183	ş 00B8 184	ş 0161 185	ş 015F 186	ţ 0165 187	ţ 017A 188	ţ 02DD 189	ţ 017E 190	ţ 017C 191
C-	Ř 0154 192	Á 00C1 193	Â 00C2 194	Ã 0102 195	Ä 00C4 196	Å 0139 197	Ç 0106 198	Ç 00C7 199	Č 010C 200	É 00C9 201	È 0118 202	Ë 00CB 203	Ě 011A 204	Í 00CD 205	Î 00CE 206	Ď 010E 207
D-	Đ 0110 208	Ń 0143 209	Ň 0147 210	Ó 00D3 211	Ô 00D4 212	Õ 0150 213	Ö 00D6 214	× 00D7 215	Ř 0158 216	Ů 016E 217	Ú 00DA 218	Ů 0170 219	Û 00DC 220	Ÿ 00DD 221	Ť 0162 222	ß 00DF 223
E-	í 0155 224	á 00E1 225	â 00E2 226	ă 0103 227	ä 00E4 228	í 013A 229	ç 0107 230	ç 00E7 231	č 010D 232	é 00E9 233	è 0119 234	ë 00EB 235	ě 011B 236	í 00ED 237	î 00EE 238	ď 010F 239
F-	đ 0111 240	ń 0144 241	ň 0148 242	ó 00F3 243	ô 00F4 244	õ 0151 245	ö 00F6 246	÷ 00F7 247	ř 0159 248	ů 016F 249	ú 00FA 250	ů 0171 251	ű 00FC 252	ü 00FD 253	ý 0163 254	· 02D9 255

User Password

This category allows you to change the user password for your phone. Changing your password ensures that only you can alter your phone settings, and helps keep your system secure. You can change your user password using the IP Phone UI or the Aastra Web UI.

If you change the password	Then you need to:
using the IP Phone UI,	use that new password to log into the Aastra Web UI.
using the Aastra Web UI,	use that new password when changing the user password via the IP Phone UI.



Note: Valid values when creating or changing a password are 0 to 4294967295 (integers only; symbols and alpha characters are not allowed). Default password is an empty string "" (field is blank).

Setting a User Password



IP Phone UI

1. Press  on the phone to enter the Options List.
2. Select **User Password** and press **Enter**.
3. At the "*Current Password*" prompt, enter the current user password and press **Enter**.
4. At the "*New Password*" prompt, enter the new user password and press **Enter**.
5. At the "*Enter Again*" prompt, re-enter the new user password and press **Enter**.
A message, "*Password Changed*" displays on the screen.



Aastra Web UI

1. Click on **Operation->User Password**.

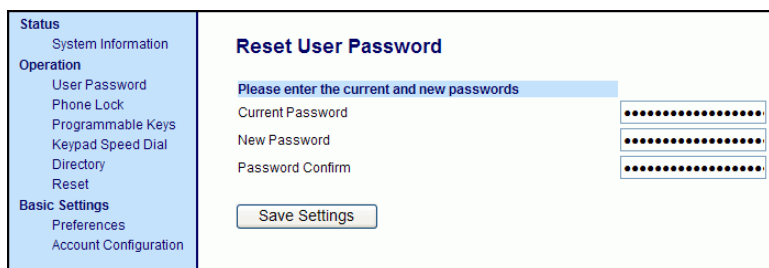

2. In the "**Current Password**" field, enter the current user password.



Note: By default, the user name is "user" (all lowercase) and the password field is left blank.

3. In the "New Password" field, enter the new user password.
4. In the "Password Confirm" field, enter the new user password again.
5. Click **Save Settings**.

Resetting a User Password

If you forget your password, you can reset it and enter a new password. The reset user password feature resets the password to the factory default which is blank (no password).

You can reset a user password using the Aastra Web UI only.



Note: Valid values when creating or changing a password are 0 to 4294967295 (integers only; symbols and alpha characters are not allowed). Default password is an empty string "" (field is blank).

Reset a User Password

Use the following procedure to reset a user password.



Aastra Web UI

1. Click on **Operation->Phone Lock**.

2. In the "Reset User Password" field, click **Reset**.
The following screen displays.

3. In the "Current Password" field, leave this blank.
4. In the "New Password" field, enter a new password.
5. In the "Password Confirm" field, re-enter your new user password.
6. Click **Save Settings**.

Restarting Your Phone

You may want to restart your phone to check for updates for your phone on the server. You may occasionally need to restart your phone to set changes or updates to your phone or network settings. You may also need to restart your phone if you have been asked to do so by your System Administrator, or should you experience any unexpected behavior.



IP Phone UI

1. Press the  button on the phone to enter the Options List.
2. Select **Restart Phone**.
3. Press # to confirm the restart of the phone. If you do not wish to restart your phone, press the 3 key to cancel.



Note: Your phone is out of service temporarily during the restart and downloading process.



Aastra Web UI

1. Click on **Operation->Reset**.

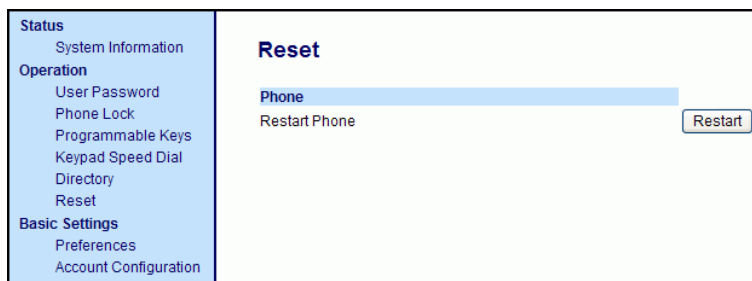

2. Click **Reset**.
3. Click **OK** at the confirmation prompt.

Phone Lock

You can lock your phone to prevent the phone from being used or configured. You can lock the phone using any of the following:

- At the path *Options->Phone Lock* on the IP Phone UI.
- At the path *Operations->Phone Lock* on the Aastra Web UI.
- At a configured key on the phone. For more information about configuring a Lock/Unlock key on your phone, see “[Phone Lock Key](#)” on [page 106](#).

In the Aastra Web UI, the *Operation->Phone Lock* path also allows you to perform the following:

- Reset a user password. Clicking on the “**Reset**” button in the “**Reset User Password**” field displays a screen that allows you to enter and save a new user password.
- Set an emergency dial plan. An emergency dial plan can be 911, 999, 112, 110 or all of the above. The default emergency dial plan is 911|999|112|110.

The following procedures describe locking the phone, setting an emergency dial plan, and resetting the user password.



Locking/Unlocking a Phone

Use the following procedures to lock an IP phone and prevent it from being used or configured.



IP Phone UI

Lock the Phone

1. Press  on the phone to enter the Options List.
 2. Select **Phone Lock** and press **Enter**.
 3. At the “*Lock the phone?*” prompt, press **Lock**.
The message “*Phone is locked*” displays.
Unlock the Phone
1. Press  on the phone to enter the Options List.
 2. At the prompt, “*Password:*”, enter your user password and press **Enter**.
The phone unlocks.



1. Click on **Operation->Phone Lock**.

Status System Information	Phone Lock
Operation User Password Phone Lock Programmable Keys Keypad Speed Dial Directory Reset	Lock or unlock the phone
Basic Settings Preferences Account Configuration	Emergency Dial Plan: 911 999 112 110
	Lock the phone? <input type="button" value="Lock"/>
	Reset User Password <input type="button" value="Reset"/>
	<input type="button" value="Save Settings"/>

Lock the Phone

2. In the "**Lock the Phone?**" field, click **Lock** .
The phone locks dynamically and displays the following message:
"Phone is locked".

Unlock the Phone

3. Click on **Operation->Phone Lock**.
4. In the "**Unlock the Phone?**" field, click **Unlock** .
The phone unlocks dynamically and displays the following message:
"Phone is unlocked".

Defining an Emergency Dial Plan

Public telephone networks in countries around the world have a single emergency telephone number (emergency services number), that allows a caller to contact local emergency services for assistance when required. The emergency telephone number may differ from country to country. It is typically a three-digit number so that it can be easily remembered and dialed quickly. Some countries have a different emergency number for each of the different emergency services.

You can specify the digits to dial on the IP phone for contacting emergency services. Once you specify the emergency number(s) on the phone, you can dial those numbers directly on the dial pad when required and the phone automatically dials to those emergency services.



Note: Contact your local phone service provider for available emergency numbers in your area.

The following table describes the default emergency numbers on the IP phones.

Emergency Number	Description
911	A United States emergency number
999	A United Kingdom emergency number
112	An international emergency telephone number for GSM mobile phone networks. In all European Union countries it is also the emergency telephone number for both mobile and fixed-line telephones.
110	A police and/or fire emergency number in Asia, Europe, Middle East, and South America.

You can set the emergency dial plan using the Aastra Web UI.

Define an Emergency Dial Plan

Use the following procedure to specify the numbers to use on your phone for dialing emergency services in your area.

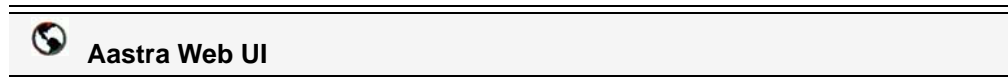

1. Click on **Operation->Phone Lock**.

2. In the "**Emergency Dial Plan**" field, enter the 3-digit number used in your local area to contact emergency services. For multiple numbers, enter a "|" between each emergency number. For example:

911|110

Default for this field is **911|999|112|110**.

3. Click **Save Settings** to save the emergency dial plan to your phone.

Reference

For more advanced options you can set on your phone, see "[Additional Features](#)" on [page 165](#).

Line Keys and Programmable Keys

This section describes the Multiple Line/Call Appearance Keys (L1, L2, and L3) and the customizable programmable keys located at the top left on the phone.

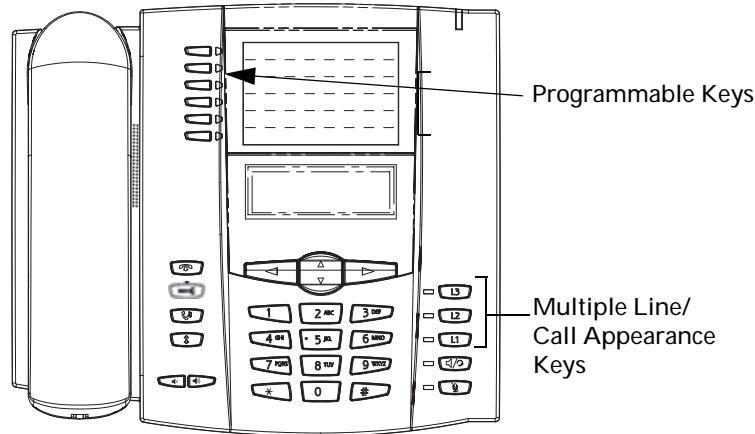

Multiple Line and Call Appearance Keys

The 6753i has 3 hard line/call appearance keys each with a corresponding status light.

These line/call appearance buttons and lights can represent physical lines, calls for your extension or calls from a group that your extension is part of. By pressing a line/call appearance button, you connect to the line or a call it represents. The line/call appearance light indicates the status of that line or call. When the phone is taken off-hook, the phone automatically selects a line for you.

Line/Call Appearance Light Behavior	Line/Call Appearance Status
Off	Idle line or no call activity
Light flashes quickly	Ringing
Light is solid	Connected
Light flashes slowly	Hold

When you have more than one call, you can use the left and right navigation buttons (3 and 4) to scroll left and right to the different call information. Icons 3 and 4 appear if there is call information either left, right or both sides of the current information you are viewing.

The display shows which line the call information is referring to (L1, L2, L3, etc.), the Caller ID information (name and number, if available), the call status (**Connected**, **Ring**, **Hold**, etc.) and the timer specific to that call.

Programmable Keys

There are six function keys on the 6753i phone, all 6 of which are programmable, located to the left of the paper label.

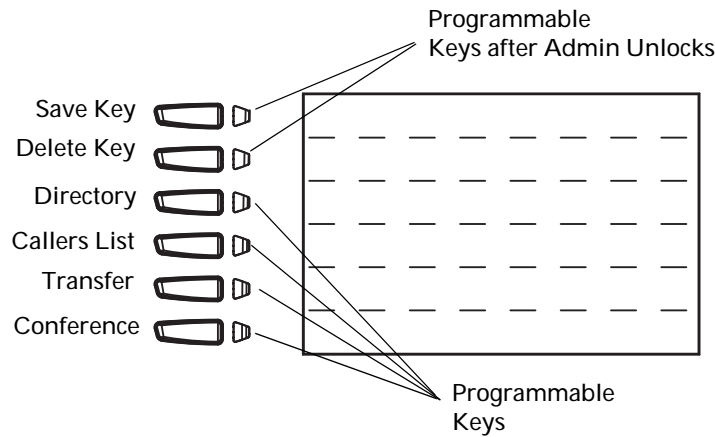

Note: The SAVE and DELETE keys are programmable ONLY after an Administrator has unlocked these keys. For more information about the SAVE and DELETE keys, see [“Configurable Save and Delete Keys”](#) on page 199.



Note: If a M670i Expansion Module(s) is attached to the phone, you can configure 36 additional keys on each Expansion Module (Phone allows up to 3 expansion modules totaling up to 108 additional keys). For more information about expansion modules, see [“Model M670i Expansion Module”](#) on page 205.

You can use the Aastra Web UI only, to configure key functions. The following table lists the functions you can set on the programmable keys and provides a description for each function.

Key Function	Description
None	Indicates no setting for the key.
Line	Indicates the key is configured for line use.
Speed Dial	Indicates the key is configured for speed dial use. You can also configure a prefix for a speed dial number.
Do Not Disturb	Indicates the key is configured for "do not disturb" on the phone.
Busy Lamp Field (BLF)	Indicates the key is configured for Busy Lamp Field (BLF) use. User can dial out on a BLF configured key. (Maximum of 50 BLFs allowed on M670i Expansion Module.)
BLF List	Indicates the key is configured for BLF list use. User can dial out on a BLF List configured key.
Auto Call Distribution (ACD)	(For Sylanro Servers) Indicates the key is configured to allow the Sylanro server to distribute calls from a queue to registered IP phone users (agents).

Key Function	Description
Directed Call Pickup (DCP)/ Group Call Pickup (GCP)	(For Sylanro Servers) Indicates the key is configured to allow you to intercept - or pickup - a call on a monitored extension(s).
XML	Indicates the key is configured to accept an XML application for accessing customized XML services. You can also specify an XML key URL for this option.
Flash	Indicates the key is set to generate a flash event when it is pressed on the 6753i. The IP phone generates flash events only when a call is connected and there is an active RTP stream (for example, when the call is not on hold).
Sprecode	Indicates the key is configured to automatically activate specific services offered by the server. For example, if the sprecode value of *82 is configured, then by pressing the Sprecode key, *82 automatically activates a service provided by the server. Contact your System Administrator for available services.
Park	Indicates the key is configured to park incoming calls when pressed.
Pickup	Indicates the key is configured to pick up parked calls when pressed.
Last Call Return (lcr)	Indicates the key is configured for "last call return" when pressed.
Call Forward	Indicates the key is configured as a Call Forward key. When pressed, the IP Phone UI displays the Call Forward menus.
BLF/Xfer	Indicates the key is configured as a simplified BLF key and a transfer key. You can use this key to perform the BLF function, or you can use it as a transfer key to transfer calls.
Speed Dial/Xfer	Indicates the key is configured as a simplified speed dial key and a transfer key. You can use this key to perform speed dial functions, or you can use it as a transfer key to transfer calls.
Speed Dial/Conf	Indicates the key is configured as a speed dial key and a conference key. You can use this key to speed dial from within a conference call, and add the new call directly to the conference.
Directory (Key 3 by Default)	Indicates the key is configured to access the Directory List.
Callers List (Key 4 by Default)	Indicates the key is configured to access the Callers List.
Transfer (Key 5 by Default)	Indicates the key is configured as a Transfer key (Xfer) for transferring calls.
Conference (Key 6 by Default)	Indicates the key is configured as a Conference key (Conf).
Intercom	Indicates the key is configured to be used for intercom calls.
Services	Indicates the key is set to access Services, such as, Directory List, Callers List, Voicemail, or any other XML applications set up by your System Administrator.

Key Function	Description
Phone Lock	Indicates the key is configured as a phone lock key, allowing you to press this key to lock/unlock the phone.
Paging	Indicates the key is configured as a Paging key. When pressed, the phone can send Real Time Transport Protocol (RTP) streams from a pre-configured multicast address without involving SIP signaling. You can also receive RTP streams from pre-configured multicast addresses (can specify up to 5 addresses) using the "Paging Listen Addresses" at the path, <i>Basic Settings->Preferences->Group Paging</i> RTP Settings in the Aastra Web UI. For more information about setting this parameter, see " Group RTP Paging (receives RTP streams) " on page 188 .

Programmable keys can also be set up to quickly to access features such as Call Return (*69) or Voicemail.



Note: Quick access features like Call Return and Voicemail must first be configured on your PBX in order to work on your phone. See your System Administrator for more information.

The following paragraphs describe how to configure each function listed in the previous table.

Line Key

You can set a programmable key or an expansion module key to act as a line/call appearance key on the 6753i. The key acts as a line that behaves the same as a hard line key (L1, L2, and L3). For more information about the behavior of line keys, see “Multiple Line and Call Appearance Keys” on page 49.

You use the Aastra Web UI to set a Line key.

Configuring a Line Key

 **Aastra Web UI**

 **Note:** Keys 1 and 2 (SAVE and DELETE keys) can be made configurable ONLY by your System Administrator.

Use the following procedure to set a Line key on your phone.

1. Click on **Operation->Programmable Keys**.
or
Click on **Operation->Expansion Module <N>**.

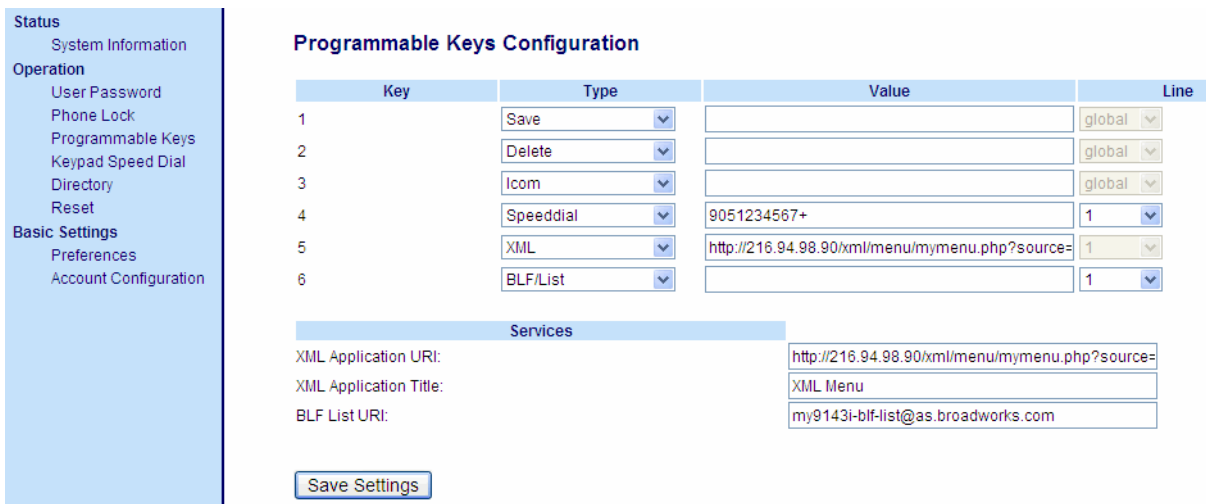

Key	Type	Value	Line
1	Save		global
2	Delete		global
3	Icom		global
4	Speeddial	9051234567+	1
5	XML	http://216.94.98.90/xml/menu/mymenu.php?source=	1
6	BLF/List		1

Services

XML Application URI:	http://216.94.98.90/xml/menu/mymenu.php?source=
XML Application Title:	XML Menu
BLF List URI:	my9143i-blf-list@as.broadworks.com

Programmable Keys and Expansion Module Keys

2. Select from "Key 3" through "Key 6".
or
Select from “Key 1” through “Key 36” (M670i).
3. In the "Type" field, select **Line** to apply to the key.
4. In the "Line" field, select a line for which to apply this key. Valid values are 4 through 9.
5. Click **Save Settings**.

Creating a Speed Dial Key

The normal function of the speed dial option allows you to dial a number quickly by pressing a key configured for speed dialing. You can program the keys on the 6753i to speed dial speed dial outside numbers, dial directly to another person's line or extension, or set up to quickly access features such as Caller ID (*69), Voicemail.

The speed dial function can be set using the IP Phone UI or the Aastra Web UI.



Note: You can use a speed dial key while on an active call by placing the active call on hold first, and then pressing the speed dial key.

You can create speed dial keys using any of the following methods:

- Using the Aastra Web UI at the paths:
 - *Operation->Programmable Keys*
 - *Operation->Expansion Module*
 - *Operation->Speed Dial Edit*
- By pressing and holding a programmable key, expansion module key, or keypad key.
- Using the IP Phone UI at the path:
 - *Options->Preferences->Speed Dial Edit*

Speed Dial Prefix

The speed dial feature also allows you to specify a preset string of numbers followed by a “+” that the phone dials automatically after pressing the speed dial key. You can use this feature for numbers that contain long prefixes.

For example, if you had the following speed dial configuration in the Aastra Web UI:

Key 1

Type=speed dial
Label=Europe Office
Value=1234567+
Line=2

then, after you press key 1 on the phone, the prefix number displays on the phone screen. The phone proceeds to dial the prefix number automatically and pauses for you to enter the remaining phone number using the keypad on the phone.

You can save up to 7 speed dial numbers on the 6753i.

Use the following procedures to set speed dial on the 6753i IP phone.

Press-and-Hold to Create a Speed Dial (applicable to programmable keys, keypad keys, expansion module keys)



IP Phone UI

Pressing and holding down a programmable key, expansion module key, or keypad key on the phone initiates a speed dial feature.



Note: When creating a speed dial for a key on the IP Phone, you must select a key that has no preassigned function (key must be set to **None**). Pressing and holding a programmable key, expansion module key, or keypad key that currently has a speed dial setting, allows you to edit that speed dial setting.

1. Press a programmable key, expansion module key, or a number key on the keypad for 3 seconds. A screen displays with the prompt, "Enter number>".
2. Enter a phone number or extension to assign to that speed dial key.
The following example illustrates the screen display:

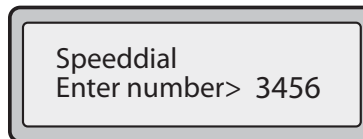

After entering the number, the prompt, "Use Save to end" displays on the screen.

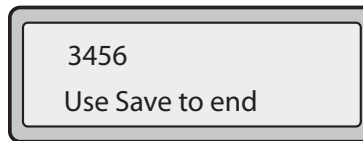

3. Press **Save** to save the number as a speed dial key.
By default, the phone automatically assigns the speed dial key to line 1 if available. To select a different line, press the **Change** key and select a different line, or use the phone's keypad to select a number (1-9), or use the 2 and 5 to make your selection.

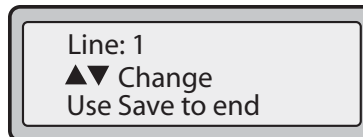

4. Press **Save** to save the speed dial key to the line specified.



Note: Press and hold a speed dial key to edit that speed dial key. If you try to edit a digit key set to "**Empty**" or "**None**", the phone proceeds to enter the "**Add a Speed Dial Key**" process. For more information about editing a speed dial key, see "[On the 6753i, you can edit a speed dial key using any of the following methods:](#)" on page 60.

Creating a Speed Dial Using the Speed Dial Edit Option

You can use the IP Phone UI at the path, *Options->Preferences->Speed Dial Edit*, to create a speed dial key.

IP Phone UI

1. Press  on the phone to enter the Options List.
2. Select **Preferences**.
3. Select **Speed Dial Edit**.

The following prompt displays:
"Press SD button"

All current speed dial key LEDs flash RED (for programmable keys and expansion module keys). All other function key LEDs turn off, during this process. After you press a speed dial key for editing, the phone restores all key LEDs to their previous state.



Note: If you select a key that is currently set as a speed dial key, the speed dial information displays for you to edit.

-
4. Press a non-configured programmable key, keypad key, or expansion module key.
 5. Enter a phone number or extension to assign to that speed dial key.
The following example illustrates the screen display:

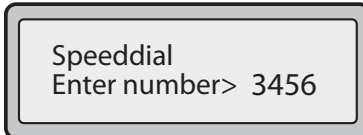

Speedial
Enter number> 3456

After entering the number, the prompt, "Use Save to end" displays on the screen.

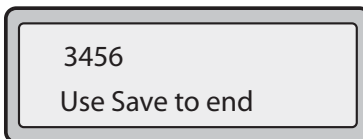

3456
Use Save to end

6. Press **Save** to save the number as a speed dial key.
By default, the phone automatically assigns the speed dial key to line 1 if available. To select a different line, press the **Change** key and select a different line, or use the phone's keypad to select a number (1-9), or use the 2 and 5 to make your selection.

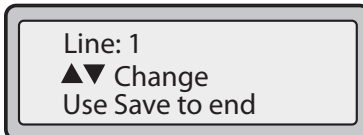

Line: 1
▲▼ Change
Use Save to end

7. Press **Save** to save the speed dial key to the line specified.

Creating a Speed Dial Key Using the Save Key



Use the following procedure to create a speed dial key using the **Save** key. Use the following illustration for reference.

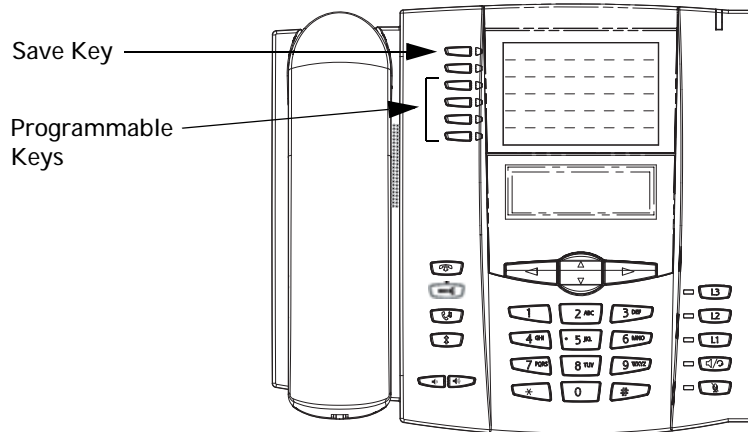

1. Press the **Save** key. The screen displays "Save to?"

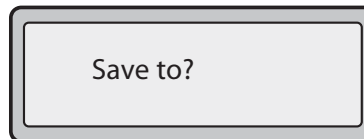

2. Select a programmable key or expansion module key you want to save to.
3. At the "**Enter Number**" prompt, use the dial pad key to enter the number.

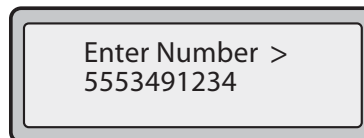

4. Press the **Save** key to save the speed dial configuration.
5. At the "**Enter Name**" prompt, use the dial pad keys to select the letters. Continue to press the number key to access the next letter for that key (i.e. press **2** three times to access **C**). Press **4** to move to the next space, or wait a moment and the cursor automatically advances. To insert a space between letters, press **4**. To backspace and erase a mistake, press **3** or the **Delete** key. You can save up to 16 letters and numbers on each programmable key entry.

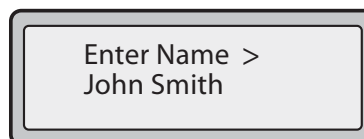

- Press the **Save** key to finish.

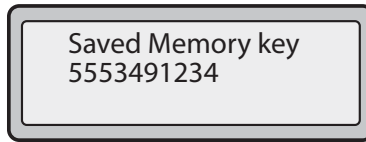

Creating a Speed Dial Using a Programmable Key or Expansion Module Key

 **Aastra Web UI**

 **Note:** Keys 1 and 2 (SAVE and DELETE keys) can be made configurable **ONLY** by your System Administrator.

- Click on **Operation->Programmable Keys**.
or
Click on **Operation->Expansion Module <N>**.

Key	Type	Value	Line
1	Save		global
2	Delete		global
3	Icom		global
4	Speeddial	9051234567+	1
5	XML	http://216.94.98.90/xml/menu/mymenu.php?source=	1
6	BLF/List		1

Services

XML Application URI: http://216.94.98.90/xml/menu/mymenu.php?source=

XML Application Title: XML Menu

BLF List URI: my9143i-blf-list@as.broadworks.com

Programmable Keys and Expansion Module Keys

- Select from "**Key 3**" through "**Key 6**".
or
Select from "**Key 1**" through "**Key 36**" (M670i).
- In the "**Type**" field, select **Speed Dial** to apply to the key.
- In the "**Value**" field, enter the phone number, extension, or speed dial prefix to apply to this hard key. If you enter a speed dial prefix, you must enter the "+" character at the end of the prefix number (for example, "123456+").
- In the "**Line**" field, select a line for which to apply the speed dial to. Valid values are **1** through **9**.
- Click **Save Settings**.

Creating Speed Dial Key Using "Keypad Speed Dial" in the Aastra Web UI



Aastra Web UI

1. Click on **Operation->Keypad Speed Dial..**

Keypad Speed Dial

Key	Value	Line
1	4771	1
2	9051234567	2
3		1
4		1
5		1
6		1
7		1
8		1
9		1

2. Select from "**Digit 1**" through "**Digit 9**".
3. In the input box, enter the phone number, extension, or speed dial prefix to apply to this Digit key. If you enter a speed dial prefix, you must enter the "+" character at the end of the prefix number (for example, "123456+").
4. In the "**Line**" field, select a line for which to apply the speed dial to. Valid values are **1** through **9**.
5. Click **Save Settings**.

Saving an Entry from the Redial, Callers, or Directory Lists to a Speed Dial Key



IP Phone UI

Use the following procedure to save an entry from your Directory List, Callers List, or Redial List on the IP phone.

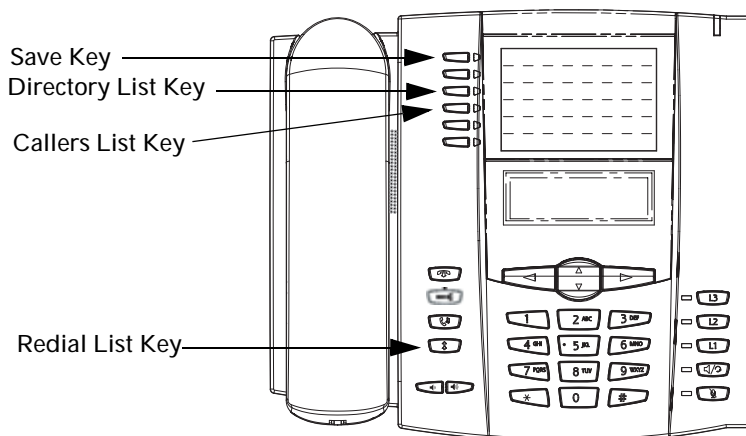

1. Press the **Directory List**, **Callers List**, or **Redial List** key. From the Directory List, Callers List, or Redial List, scroll through the list to find the name and number that you wish to save to your speed dial.
2. Press the **Save** key.
3. Press the selected speed dial. If the name is displayed with the number, both are saved to the speed dial. If no name is displayed, you can enter the name using the phone's key pad.

Editing Speed Dial Keys

On the 6753i, you can edit a speed dial key using any of the following methods:

- Using the Aastra Web UI at the path:
 - *Operation->Programmable Keys*
 - *Operation->Expansion Module Keys*
 - *Operation->Keypad Speed Dial*
- Using the IP Phone UI at the path:
 - *Options->Preferences->Speed Dial Edit.*

The following illustration shows the path in the 6753i IP Phone UI for editing a speed dial key.

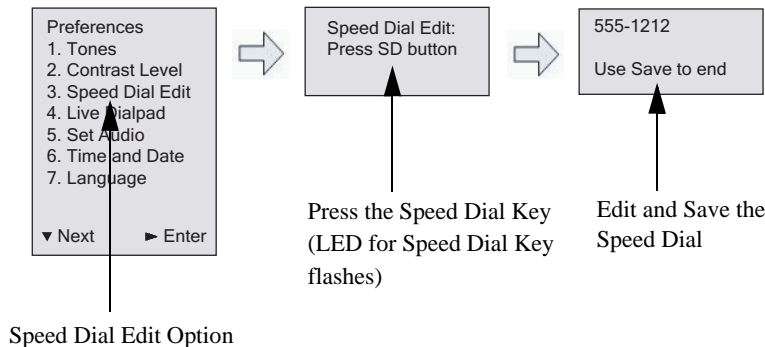

IP Phone UI

Use the following procedure to edit a speed dial key from the IP Phone UI.



Note: *A speed dial key must be already configured on the phone to edit the key.

1. Press  on the phone to enter the Options List.
2. Select **Preferences**.

3. Select *Speed Dial Edit*.

All current speed dial key LEDs flash RED (for programmable keys and expansion module keys). All other function key LEDs turn off, during this process. After you press a speed dial key for editing, the phone restores all key LEDs to their previous state.

4. Press a speed dial key you want to edit.

The speed dial edit screen displays.



Notes:

1. If a number on the keypad is setup as a speed dial key, pressing the applicable number in the speed dial editing process also displays the speed dial edit screen. The edit screen allows you to change the Speed Dial Number and Line setting.

2. If you press a key that is NOT setup as a speed dial key, the phone displays an “*Invalid Key*” message. However, if you press-and-hold an empty keypad key, programmable key, or expansion module key that is set to "NONE", it initiates the “Add a Speed Dial Key” process allowing you to setup a new speed dial key. For more information, see “[Press-and-Hold to Create a Speed Dial \(applicable to programmable keys, keypad keys, expansion module keys\)](#)” on [page 55](#).

5. Edit the speed dial information as applicable and press SAVE.



Notes:

1. You can cancel out of the speed dial editing process at any time without saving, by pressing the  key.

2. You can also use the (up arrow) key to cancel when in Extension editing or the 3 (left arrow) key to cancel if in Line editing. Pressing either of these keys displays the idle screen.

On the 6753i, you can remove the Speed Dial Key by erasing the speed dial number digits (leaving the speed dial value blank) and then press SAVE or the (right arrow) key. Use the left arrow key to delete the digits.

Editing a Speed Dial on a Programmable Key or Expansion Module Key



Aastra Web UI

1. Click on **Operation->Programmable Keys**.
or
Click on **Operation->Expansion Module <N>**.

Key	Type	Value	Line
1	Save		global
2	Delete		global
3	Icom		global
4	Speeddial	9051234567+	1
5	XML	http://216.94.98.90/xml/menu/mymenu.php?source=	1
6	BLF/List		1

Services

XML Application URI:
XML Application Title:
BLF List URI:

2. Select the key configured for speed dial.
3. In the "**Value**" field, edit the phone number, extension, or speed dial prefix to apply to this hard key. If you enter a speed dial prefix, you must enter the "+" character at the end of the prefix number (for example, "123456+").
4. If required in the "**Line**" field, select a line for which to apply the speed dial to. Valid values are 1 through 9.
5. Click **Save Settings**.



Note: You can delete a speed dial key by removing the information from the "**Value**" field.

Editing a Speed Dial Using “Keypad Speed Dial” in the Aastra Web UI



Aastra Web UI

1. Click on **Operation->Keypad Speed Dial**.

Keypad Speed Dial

Key	Value	Line
1	4771	1
2	9051234567	2
3		1
4		1
5		1
6		1
7		1
8		1
9		1

2. Select from "**Digit 1**" through "**Digit 9**".
3. In the input box, edit the phone number, extension, or speed dial prefix for this Digit key. If you enter a speed dial prefix, you must enter the "+" character at the end of the prefix number (for example, "123456+").
4. In the "**Line**" field, select a line for which to apply the speed dial to. Valid values are **1** through **9**.
5. Click **Save Settings**.

Do Not Disturb (DND) Key

The IP phones have a feature you can enable called "Do not Disturb (DND)". The DND function allows you to turn "do not disturb" ON and OFF.



Note: You can configure DND using the Aastra Web UI only.

If DND is ON, callers calling into the phone hear a busy signal or a message, depending on how your System Administrator set up the configuration server. The second line on the screen of the IP phone shows when DND is set.

If the phone shares a line with other phones, only the phone that has DND configured is affected.

You can set DND on the programmable keys or expansion module keys using the Aastra Web UI only. DND is not configurable from the IP phone UI.

Configuring a DND Key



Aastra Web UI



Note: Keys 1 and 2 (SAVE and DELETE keys) can be made configurable ONLY by your System Administrator.

1. Click on **Operation->Programmable Keys**.
or
Click on **Operation->Expansion Module <N>**.

Key	Type	Value	Line
1	Save		global
2	Delete		global
3	Icom		global
4	Speeddial	9051234567+	1
5	XML	http://216.94.98.90/xml/menu/mymenu.php?source=	1
6	BLF/List		1

Services

XML Application URI:
XML Application Title:
BLF List URI:

Programmable Keys and Expansion Module Keys

2. Select from "**Key 3**" through "**Key 6**".
or
Select from "**Key 1**" through "**Key 36**" (M670i).
3. In the "**Type**" field, select **do not disturb** to apply to this key.

Busy Lamp Field (BLF) Key

The BLF feature on the IP phones allows a specific extension to be monitored for state changes. BLF monitors the status (busy or idle) of extensions on the IP phone.



Note: The BLF setting is applicable to the Asterisk server only.

Example

A Supervisor configures BLFs on his phone for monitoring the status of a worker's phone use (busy or idle). When the worker picks up his phone to make a call, a busy indicator on the Supervisor's phone shows that the worker's phone is in use and busy.

On the 6753i, the busy and idle indicators are the LEDs next to each BLF key. The LED illuminates steady to indicate the monitored line is off-hook or unregistered. The LED goes off when the line is idle.

You can set BLF on the programmable keys or expansion module keys using the Aastra Web UI only. BLF is not configurable from the IP phone UI.



Note: You can also use a BLF configured key to dial out. Contact your System Administrator for more information

Configuring a BLF Key



Aastra Web UI



Note: Keys 1 and 2 (SAVE and DELETE keys) can be made configurable ONLY by your System Administrator.

1. Click on **Operation->Programmable Keys**.
or
Click on **Operation->Expansion Module <N>**.

Key	Type	Value	Line
1	Save		global
2	Delete		global
3	Icom		global
4	Speeddial	9051234567+	1
5	XML	http://216.94.98.90/xml/menu/mymenu.php?source=	1
6	BLF/List		1

Services

XML Application URI: http://216.94.98.90/xml/menu/mymenu.php?source=
XML Application Title: XML Menu
BLF List URI: my9143i-blf-list@as.broadworks.com

Programmable Keys and Expansion Module Keys

2. Select from "**Key 3**" through "**Key 6**".
or
Select from "**Key 1**" through "**Key 36**" (M670i).
3. In the "**Type**" field, select **BLF** to apply to this key.
4. In the "**Value**" field, enter the phone number or extension you want to monitor.
5. In the "**Line**" field, select a line for which to apply to this key. Valid values are **Global** (for all lines), or **1** through **9**.
6. Click **Save Settings**.

BLF List Key

(For use with the BroadSoft Broadworks Rel 13 or higher platform only)

The BLF\List feature on the IP phones is specifically designed to support the BroadSoft Broadworks Rel 13 Busy Lamp Field feature.

This feature allows the IP phone to subscribe to a list of monitored users defined through the BroadWorks web portal.



Note: Your System Administrator must have BLF List enabled on the BroadWorks Server. Contact your System Administrator for more information.

In addition to monitoring the idle and busy state, the BLF\List feature also supports the ringing state. On the 6753i phone, the LED lights next to each BLF key illuminate steady to indicate the monitored line is off-hook or unregistered. The LED goes off when the is idle. When the monitored extension is ringing, the LED flashes.



Note: You can use a BLF\List configured key to dial out.

Example

A receptionist has a 6753i running Broadsoft firmware that subscribes to a list of extensions from the BroadWorks Application Server. On the 6753i running Broadsoft firmware, the key LEDs illuminate either flashing, solid, or turn off depending on the state of those extensions.



Note: The Broadworks BLF feature is not the same as the Broadworks Shared Call Appearance (SCA) feature and does not permit call control over the monitored extension.

Configuring a BLF List Key



Aastra Web UI

The BLF List function can be configured on the 6753i using the Aastra Web UI only.

If you set a key to use BLF/List, you must also enter a **BLF List URI** at *Operation->Programmable Keys->Services*. The BLF List URI is the name of the BLF list defined on the BroadSoft BroadWorks Busy Lamp field page for your particular user. For example, my480i-blf-list@as.broadworks.com. The value of the BLF/List URI parameter must match the list name configured. Otherwise, no values display on the 6753i screen and the feature is disabled.



Note: Keys 1 and 2 (SAVE and DELETE keys) can be made configurable ONLY by your System Administrator.

1. Click on **Operation->Programmable Keys**.
or
Click on **Operation->Expansion Module <N>**.

Key	Type	Value	Line
1	Save		global
2	Delete		global
3	Icom		global
4	Speeddial	9051234567+	1
5	XML	http://216.94.98.90/xml/menu/mymenu.php?source=	1
6	BLF/List		1

Services

XML Application URI: http://216.94.98.90/xml/menu/mymenu.php?source=

XML Application Title: XML Menu

BLF List URI: my9143i-blf-list@as.broadworks.com

Programmable Keys and Expansion Module Keys

2. Select from "Key 3" through "Key 6".
or
Select from "Key 1" through "Key 36" (M670i).
3. In the "Type" field, select "BLF/List" (BroadSoft BroadWorks).
4. In the "Line" field, select a line number that is actively registered to the appropriate SIP proxy you are using. Valid values are **Global** (for all lines), or **1** through **9**.

5. In the "**BLF List URI**" field, enter the name of the BLF list defined on the BroadSoft BroadWorks Busy Lamp field page for your particular user. For example, my6753i-blf-list@as.broadworks.com.



Note: Contact your System Administrator for the BLF List URI.

6. Click **Save Settings**.

Flash Key

You can set a programmable key or expansion module key to generate a flash event when it is pressed on the 6753i. You do this by setting the key to "**flash**". The IP phone generates flash events only when a call is connected and there is an active RTP stream (for example, when the call is not on hold).

Configuring a Flash Key



Aastra Web UI



Note: Keys 1 and 2 (SAVE and DELETE keys) can be made configurable ONLY by your System Administrator.

1. Click on **Operation->Programmable Keys**.
or
Click on **Operation->Expansion Module <N>**.

Key	Type	Value	Line
1	Save		global
2	Delete		global
3	Icom		global
4	Speeddial	9051234567+	1
5	XML	http://216.94.98.90/xml/menu/mymenu.php?source=	1
6	BLF/List		1

Services	
XML Application URI:	http://216.94.98.90/xml/menu/mymenu.php?source=
XML Application Title:	XML Menu
BLF List URI:	my9143i-blf-list@as.broadworks.com

Programmable Keys and Expansion Module Keys

2. Select from "**Key 3**" through "**Key 6**".
or
Select from "**Key 1**" through "**Key 36**" (M670i).
3. In the "**Type**" field, select **flash**.
4. Click **Save Settings**.

Automatic Call Distribution (ACD) Key (for Sylanro Servers)

The 6753i and any attached Expansion Modules support Automatic Call Distribution (ACD) for Sylanro servers. The ACD feature allows the Sylanro server to distribute calls from a queue to registered IP phone users (agents).

To use the ACD feature on an IP phone, you must first configure an ACD key or Expansion Module key. When you want to subscribe to a queue (in order to receive incoming calls), you press the ACD key and the IP phone UI prompts you to specify the following information:

- **User ID:** the phone number(s) used to login into the queue.
- **Password:** the password used to login to the queue.
- **Available/unavailable:** Shows the current status of the IP phone. Specifies if the IP phone user is available/unavailable to receive a call from the queue.



Note: Your System Administrator must provide you with your User ID and Password to access the applicable phone queue.

After creating an ACD key, you are ready to receive calls from a queue on the server. You must press the ACD key and then log in by entering your User ID and Password. An "Available" key displays allowing you to make your phone available to accept these calls.

When you are on an active call, or you miss a call, the server automatically changes the phone's status to unavailable. The server updates its database with this new information and no longer distributes calls to the phone. The phone remains in this "unavailable" state until:

- you make yourself "available" again by pressing the "Available" key.
- an ACD timer expires (set by your System Administrator).

You can also choose to manually change the phone status to unavailable by pressing the "Unavailable" key on the phone.



Note: It is recommended you configure no more than a single ACD key, programmable key, or expansion module key per IP phone.

Configuring an Automatic Call Distribution (ACD) Key

Use the following procedure to configure ACD on the 6753i IP Phone.



Aastra Web UI



Note: Keys 1 and 2 (SAVE and DELETE keys) can be made configurable ONLY by your System Administrator.

1. Click on **Operation->Programmable Keys**.
or
Click on **Operation->Expansion Module <N>**.

Key	Type	Value	Line
1	Save		global
2	Delete		global
3	Icom		global
4	Speeddial	9051234567+	1
5	XML	http://216.94.98.90/xml/menu/mymenu.php?source=	1
6	BLF/List		1

Services

XML Application URI:
XML Application Title:
BLF List URI:

Programmable Keys and Expansion Module Keys

2. Select from "**Key 3**" through "**Key 6**".
or
Select from "**Key 1**" through "**Key 36**" (M670i).
3. In the "**Type**" field, select **Automatic call distribution**.
4. In the "**Line**" field, select a line to apply Automatic call distribution. Valid values are **1** through **9**.



Note: It is recommended you configure no more than a single ACD programmable key or expansion module key per IP phone.

5. Click **Save Settings**.

Using the ACD Feature on your IP Phone

The ACD feature allows you to login to a phone queue in order to receive distributed calls on your IP phone. To login to a phone queue, you must preconfigure an ACD key on your IP Phone as described in the previous procedure.

Your Administrator sets up the queue that you access when you press the ACD Key. Contact your System Administrator for more information.

When you press the ACD Key, the phone prompts you to enter a User ID and Password to login into the queue. Once logged in, you can make your phone “available” or “unavailable” to take calls by pressing the Available/Unavailable Key (2). The server monitors your IP phone status. When you set the IP phone to “available,” the server begins distributing calls to your phone. When you set the IP phone to “unavailable,” the server temporarily stops distributing calls to your phone.

The LED for the ACD Key shows the current status of your phone.

ACD LED Table

This LED changes when you log into the phone queue and are available to take calls. The LED changes again when you are busy with an active call. The table below shows the status of the LED as they may appear on your IP phone.

Phone Model	Status: Logged In and Available	Status: Unavailable	Logged Out
6753i	Solid Red LED	Blinking red LED	No LED

Using the ACD Key

Use the following procedure to log into a phone queue from your IP phone.



IP Phone UI

1. Check with your Administrator to verify the queue linked to your ACD Key.
2. Press the **ACD Key** on your IP phone.
The LCD displays the label of the ACD queue you are accessing.
The "*User ID*" prompt displays.

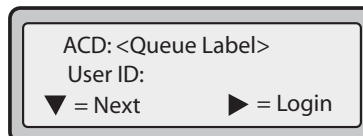

- Using the keypad, enter your User ID (phone number provided by your System Administrator) and press the 2 Key.
The "Password" prompt displays.

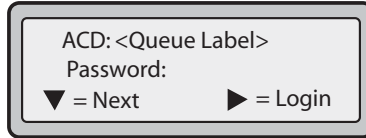

- Using your keypad, enter your Password (provided by your System Administrator) and press the 2 Key.
- Press 4 (Login) to login to the queue.
You are logged into the queue and the following screen displays.

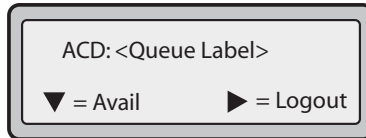

- To allow your phone to be available in the queue, press 2 (Avail).
The following screen displays.



If your IP phone status is set to “**Available**” then the server begins to distribute phone calls from this queue to your IP phone. You must manually change the state to “**Available**” in order to start receiving calls.

- To temporarily stop receiving calls, press the press 2 (Unavail).

If you are on a call (or miss a call that has been distributed to your phone), your phone status automatically changes to “**Unavailable**”. Your phone remains in the “**Unavailable**” state until one of the following occurs:

- You use the IP Phone UI to manually switch the IP phone state back to “Available”.
- or
- The availability “timer” for your IP phone expires. This only occurs if your Administrator has configured an auto-availability timer on your IP phone. Contact your System Administrator for more information.

- To logout of the queue, press 4 (Logout).

The server no longer distributes phone calls to your IP phone.

Directed Call Pickup/Group Call Pickup Keys (for Sylanro Servers)

Aastra IP phones support the Directed Call Pickup (DCP) and Group Call Pickup (GCP) features.

The DCP/GCP feature allows you to intercept - or pickup - a call on a monitored extension. You can configure this feature using the Aastra Web UI to create a DCP or GCP key on the IP phone. When you configure a DCP key, you specify the extension that you want to monitor. Then, when the monitored extension receives a call, you press the DCP key to pick up the call. If the monitored extension receives multiple incoming calls simultaneously, the IP Phone UI displays a list of incoming calls. You select a call from this list, and are connected to the call.

When you configure a GCP key, you specify the ring group (for example, extensions 2200 - 2210) that you want to monitor for incoming calls. When an incoming call is received on any of these extensions, the Operator presses the GCP key and is connected to the call. If multiple incoming calls are received simultaneously, the Operator press the GCP key, selects an extension from a list, and presses the **Pickup** key to answer the call.



Note: Your System Administrator must configure the extension range for the Group Call Pickup feature. Contact your System Administrator for more information.

Configuring Directed Call Pickup (DCP) Key (for Sylanro Servers)

Use the following procedure to configure Directed Call Pickup using the Aastra Web UI.



Aastra Web UI



Note: Keys 1 and 2 (SAVE and DELETE keys) can be made configurable ONLY by your System Administrator.

1. Click on **Operation->Programmable Keys**.
or
Click on **Operation->Expansion Module <N>**.

Key	Type	Value	Line
1	Save		global
2	Delete		global
3	Icom		global
4	Speeddial	9051234567+	1
5	XML	http://216.94.98.90/xml/menu/mymenu.php?source=	1
6	BLF/List		1

Services

XML Application URI:
XML Application Title:
BLF List URI:

Programmable Keys and Expansion Module Keys

2. Select from "**Key 3**" through "**Key 6**".
or
Select from "**Key 1**" through "**Key 36**" (M670i).
3. In the "**Type**" field, select **Directed Call Pickup**.
4. In the "**Value**" field, specify the extension you want to intercept when you press this key.
For example: **2200**.
5. In the "**Line**" field, select the line for which to apply the Directed Call Pickup configuration.
Valid values are **1** through **9**.
6. Click **Save Settings**.

Configuring Group Call Pickup (GCP) Key (for Sylantrio Servers)

Use the following procedure to configure Group Call Pickup using the Aastra Web UI.



 **Note:** A ring group must be configured on the Sylantrio Server in order for a GCP key to function.

1. Click on **Operation->Programmable Keys**.
or
Click on **Operation->Expansion Module <N>**.

2.

Key	Type	Value	Line
1	Save		global
2	Delete		global
3	Icom		global
4	Speeddial	9051234567+	1
5	XML	http://216.94.98.90/xml/menu/mymenu.php?source=	1
6	BLF/List		1

Services

XML Application URI: http://216.94.98.90/xml/menu/mymenu.php?source=

XML Application Title: XML Menu

BLF List URI: my9143i-blf-list@as.broadworks.com

Save Settings

3. Select a key for which to configure Group Call Pickup.
4. In the “**Type**” field, select **Directed Call Pickup**.
5. In the “**Value**” field, enter **groupcallpickup**.
6. In the “**Line**” field, select the line for which to apply the Group Call Pickup configuration. Valid value are **1** through **9**.
7. Click **Save Settings**.

Using Directed Call Pickup/Group Call Pickup

Use the following procedure for the DCP/GCP feature on your phone.



IP Phone UI



Note: Before using the DCP/GCP feature on your phone, you must first configure the DCP or GCP Key. You must identify the extension(s) or phone number(s) you want to monitor when configuring the key. See the previous procedures to configure a DCP or GCP Key.

Using Directed Call Pickup (DCP)

1. When the monitored extension receives a call, press the **DCP** Key to pick up the call. If the monitored extension receives multiple incoming calls simultaneously, the phone displays a list of incoming calls.
2. Use the 5 and 2 keys to scroll through the list to select an extension.
3. Press 2 (Pickup) Key for the extension you select. The call is answered.

Using Group Call Pickup (GCP)

1. If any of the monitored group of extensions receives a call, press the **GCP Key**.

The call is answered. If the monitored group of extensions receives multiple incoming calls simultaneously, the phone displays a list of incoming calls.

2. Use the 5 and 2 keys to scroll through the list to select an extension.
3. Press 2 (Pickup) Key for the extension you select.
The call is answered.

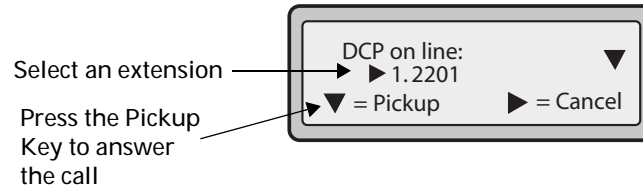

XML Key

The 6753i IP phone has a feature you can enable called "XML" (Extensible Markup Language). XML is a markup language much like HTML. Your System Administrator can create customized XML menu services and load them to your IP phone. These services include things like weather and traffic reports, contact information, company info, stock quotes, or custom call scripts. You can configure XML using the Aastra Web UI only.

Using the Aastra Web UI, you can configure a key to access XML applications. Under *Operations->Programmable Keys* or *Operation->Expansion Module*, you can assign a key the type "XML".



Note: The XML services must be set up by your System Administrator before you can use the key. Contact your System Administrator for more information.

You must also specify an XML URI and a Services label using the following XML fields:

- XML Application URI
- XML Application Title

The XML Application URI is the URI loaded by your phone. The phone performs an HTTP GET. Contact your System Administrator for the applicable XML URI to enter in the "XML Application URI" field.

The XML Application Title is the label that displays beside the XML key on your phone. If you use the Services key to access the XML features, the "XML Application Title" is the label that displays on the Services Menu in the IP Phone UI.



Note: Contact your System Administrator for the applicable URI to enter in this field.

After an XML key is configured, you can use the IP Phone UI to access the XML applications.

Configuring an XML Key



Aastra Web UI



Note: Keys 1 and 2 (SAVE and DELETE keys) can be made configurable ONLY by your System Administrator.

1. Click on **Operation->Programmable Keys**.
or
Click on **Operation->Expansion Module <N>**.

Key	Type	Value	Line
1	Save		global
2	Delete		global
3	Icom		global
4	Speeddial	9051234567+	1
5	XML	http://216.94.98.90/xml/menu/mymenu.php?source=	1
6	BLF/List		1

Services

XML Application URI:
XML Application Title:
BLF List URI:

Programmable Keys and Expansion Module Keys

2. Select from "**Key 3**" through "**Key 6**".
or
Select from "**Key 1**" through "**Key 36**" (M670i).
3. In the "**Type**" field, select **XML** to apply to the key.
4. In the "**Value**" field, enter a URI(s) to apply to this key.



Note: Contact your System Administrator for the appropriate value to enter in the "Value" field.

If you specify multiple URIs in the "**Value**" field, a list of XML applications appears for selection after pressing the **XML** key.

5. In the "**XML Application URI**" field, enter the XML application URI provided by your System Administrator.
6. In the "**XML Application Title**" field, enter the XML application title that you want to display as the title for the key on your phone.
7. Click **Save Settings**.

Accessing the XML Service

After an XML application(s) have been saved to your IP phone, and after a key has been configured to access the XML application(s), the customized service is ready for you to use.



IP Phone UI

1. Press the key configured for XML on the 6753i phone. A "**Custom Features**" screen displays or the title you specified.
2. Use the 5 and 2 to scroll through the customized features.
3. For menu and directory services, select a service to display the information for that customized service. Message services display to the screen after pressing the key. For user input services, follow the prompts as appropriate.
4. To exit from the "**Customized Features**" screen, press the XML key again.

Sprecode Key

You can set a programmable key or expansion module key to automatically activate specific services offered by the server. For example, if the sprecode value of *82 is configured, then by pressing the Sprecode key, *82 automatically activates a service provided by the server. Contact your System Administrator for information about available services.



Aastra Web UI



Note: Keys 1 and 2 (SAVE and DELETE keys) can be made configurable ONLY by your System Administrator.

Configuring a Sprecode Key

Use the following procedure to configure a sprecode key on the 6753i phone.

1. Click on **Operation->Programmable Keys**.
or
Click on **Operation->Expansion Module <N>**.

Key	Type	Value	Line
1	Save		global
2	Delete		global
3	Icom		global
4	Speeddial	9051234567+	1
5	XML	http://216.94.98.90/xml/menu/mymenu.php?source=	1
6	BLF/List		1

Services

XML Application URI:
XML Application Title:
BLF List URI:

Programmable Keys and Expansion Module Keys

2. Select from "**Key 3**" through "**Key 6**".
or
Select from "**Key 1**" through "**Key 36**" (M670i).
 3. In the "**Type**" field, select **sprecode**.
 4. In the "**Value**" field, enter the appropriate value for accessing specific services from the server.
-



Note: For values to enter in this field, contact your System Administrator.

5. Click **Save Settings**.

Park/Pickup Keys

The 6753i phone has a park and pickup call feature that allows you to park a call and pickup a call when required. The IP phones support the Park/Pickup feature on the Asterisk, BroadWorks, and Sylantrio servers.

The park/pickup feature performs as follows:

- When a call comes in and you pickup the handset, you can press the applicable "Park" key to park the call.
- After the call is parked, you can press the "Pickup" key, followed by the applicable value to pickup the call.

Administrators can configure the park and pickup keys for any line using the configuration files or the Aastra Web UI. Users can make changes to customize the label of the park/pick up keys using the Web UI.

Configuring Park/Pickup Keys



 **Note:** Keys 5 and 6 (SAVE and DELETE keys) can be made configurable ONLY by your System Administrator.

Use the following procedure to configure park/pickup on the 6753i phone:

1. Click on **Operation->Programmable Keys**.

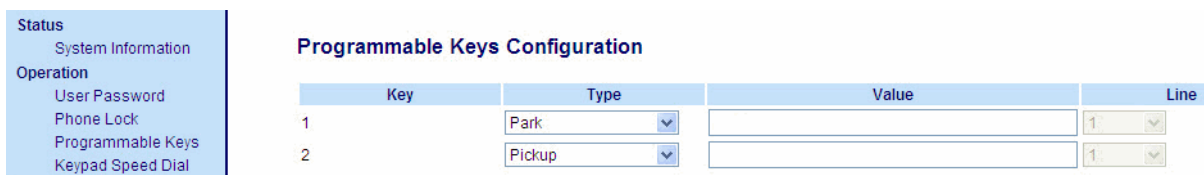

2. Select from "**Key 1**" through "**Key 8**". (Keys 5 and 6 can be made configurable only by your system administrator.)
3. In the "**Type**" field, select **Park**.

 **Note:** The "Value" and "Line" fields are configured by the Administrator.

4. Select from "**Key 1**" through "**Key 8**".
5. In the "**Type**" field, select **Pickup**.

6. Click **Save Settings**.
7. Click on **Reset**, then click **Restart** to restart the IP phone and apply the changes.

Using the Park Call/Pickup Parked Call Feature

Use the following procedure on the IP phone to park a call and pick up a parked call.

Park a Call

1. While on a live call, press the "**Park**" key.
2. Perform the following for your specific server:

For Asterisk Server
Server announces the extension number where the call has been parked. Once the call is parked, press the  key to complete parking.
For BroadWorks Server
After you hear the greeting from the CallPark server, enter the extension where you want to park the call.
For Sylanro Server
Enter the extension number where you want to park the call, followed by "#" key.
For ININ Server
Enter the extension number where you want to park the call, followed by "#" key.

If the call is parked successfully, the response is either a greeting voice confirming that the call was parked, or a hang up occurs. The parked call party hears music on hold.

3. If the call fails, you can pick up the call (using the next procedure) and press the "**Park**" key again to retry step 2.

Pickup a Parked Call

1. Pick up the handset on the phone.
2. Enter the extension number where the call was parked.
3. Press the "**Pickup**" key.

If the call pick up is successful, you are connected with the parked call.

Last Call Return (lcr) Key (for Sylanro Servers)

Using the Aastra Web UI, you can configure the "Last call return" (lcr) function on a key. This feature is for Sylanro servers only.

How it works

If you configure "lcr" on a key, and a call comes into your phone, after you are finished with the call and hang up, you can press the key configured for "lcr" and the phone dials the last call you received. When you configure an "lcr" key, the label "LCR" displays next to that key on the IP phone. When the Sylanro server detects an "lcr" request, it translates this request and routes the call to the last caller.

Configuring a Last Call Return Key



Aastra Web UI



Note: Keys 1 and 2 (SAVE and DELETE keys) can be made configurable ONLY by your System Administrator.

1. Click on **Operation->Programmable Keys**.
or
Click on **Operation->Expansion Module <N>**.

Key	Type	Value	Line
1	Save		global
2	Delete		global
3	Icom		global
4	Speeddial	9051234567+	1
5	XML	http://216.94.98.90/xml/menu/mymenu.php?source=	1
6	BLF/List		1

Services

XML Application URI:
XML Application Title:
BLF List URI:

Programmable Keys and Expansion Module Keys

2. Select from "**Key 3**" through "**Key 6**".
or
Select from "**Key 1**" through "**Key 36**" (M670i).
3. In the "**Type**" field, select **Last Call Return**.

4. In the "**Line**" field, select the line to apply this feature.
Valid values are **1** through **9**.
5. Click **Save Settings**.

Call Forward Key

Using the Aastra Web UI, you can configure the "Call Forward" function on a key. Use call forwarding when you want a specific account on your phone to be forwarded to another number when your phone is in the busy state or the no answer state, or both. Pressing the Call Forward key on the phone accesses the Call Forward Menus. The menus that display are dependant on the Call Forward mode (**Account** (default), **Phone**, or **Custom**) configured for the phone.

For more information about call forwarding and call forwarding modes, see "[Call Forward Account-Based Configuration](#)" on page 148.

Configuring a Call Forward

 **Aastra Web UI**

 **Note:** Keys 1 and 2 (SAVE and DELETE keys) can be made configurable ONLY by your System Administrator.

1. Click on **Operation->Programmable Keys**.
or
Click on **Operation->Expansion Module <N>**.

Status

System Information

Operation

User Password

Phone Lock

Programmable Keys

Keypad Speed Dial

Directory

Reset

Basic Settings

Preferences

Account Configuration

Programmable Keys Configuration

Key	Type	Value	Line
1	Save		global
2	Delete		global
3	Icom		global
4	Speeddial	9051234567+	1
5	XML	http://216.94.98.90/xml/menu/mymenu.php?source=	1
6	BLF/List		1

Services

XML Application URI:

XML Application Title:

BLF List URI:

Programmable Keys and Expansion Module Keys

2. Select from "**Key 3**" through "**Key 6**".
or
Select from "**Key 1**" through "**Key 36**" (M670i).
3. In the "**Type**" field, select **Call Forward**.
4. Click **Save Settings**.

BLF/Xfer

The BLF key allows one or more extensions to be monitored, and once there is any state change with those extensions, the key shows the status of the monitored lines. The Xfer key allows a call to be transferred to other recipients blindly or consultatively. The BLF/Xfer key combines the BLF and Xfer key's functionality together allowing the user to transfer calls or use BLF with one key.



Note: It is recommended that you enable the “Switch UI Focus to Ringing Line” parameter when using the BLF/Xfer feature. For more information about this parameter, see “Switch UI Focus to Ringing Line” on [page 179](#).

BLF/Xfer Key Requirements and Functionality

- **BLF/Xfer and BLF**

A BLF/Xfer key can be configured for subscribing to an extension and monitor the status of the extension, similar to the BLF key functionality. Changes of the state of the monitored extension are indicated by a LED / Icon.

- **BLF/Xfer and Blind Transfer Calls**

When the focused line is in the “Connected” state, pressing the BLF/Xfer key transfers the call to the extension unconditionally, disregarding the status of the monitored extension.

If transferring a call to an extension fails, a message “Transfer Failed” displays on the phone, and you can reconnect the call (get the call back) by pressing the line key again.

- **BLF/Xfer and Call Forward**

When the focused line is in the “Ringing” state, pressing the BLF/Xfer key forwards the call to the extension unconditionally, disregarding the status of the monitored extension.

- **BLF/Xfer and Speed Dial**

When the focused line and the monitored extension are idle, pressing the BLF/Xfer key causes the phone to go offhook and dial the number of the extension.

Configuring a BLF/Xfer Key



Aastra Web UI



Note: Keys 1 and 2 (SAVE and DELETE keys) can be made configurable ONLY by your System Administrator.

1. Click on **Operation->Programmable Keys**.
or
Click on **Operation->Expansion Module <N>**.

Key	Type	Value	Line
1	Save		global
2	Delete		global
3	Icom		global
4	Speeddial	9051234567+	1
5	XML	http://216.94.98.90/xml/menu/mymenu.php?source=	1
6	BLF/List		1

Services

XML Application URI:
XML Application Title:
BLF List URI:

Programmable Keys and Expansion Module Keys

2. Select from "**Key 3**" through "**Key 6**".
or
Select from "**Key 1**" through "**Key 36**" (M670i).
3. In the "**Type**" field, select **BLF/Xfer**.
4. In the "**Value**" field, enter the monitored extension or the extension to transfer calls to (for example, "**35**").
5. In the "**Line**" field, select the line for which you want to use the key functionality.
6. Click **Save Settings**.

Speed Dial/Xfer

The Speed Dial key allows a number to be dialed quickly by pressing one key configured for speed dialing. The Xfer key allows a call to be transferred to other recipients blindly or consultatively. The Speed Dial/Xfer key combines the Speed Dial and Xfer key's functionality together allowing the user to transfer calls or use Speed Dial with one key.



Note: It is recommended that you enable the “Switch UI Focus to Ringing Line” parameter when using the Speed Dial/Xfer feature. For more information about this parameter, see “Switch UI Focus to Ringing Line” on [page 179](#).

Speed Dial/Xfer Key Requirements and Functionality

The Speed Dial/Xfer key has the following capabilities:

- **Speed Dial/Xfer and Speed Dial**
When the phone is in the “Idle” state, pressing the Speed Dial/Xfer key causes the phone to go offhook and dial the predefined extension.
- **Speed Dial/Xfer and Blind Transfer**
When the phone is connected to a call, pressing the Speed Dial/Xfer key blind transfers the call to the predefined target.

If transferring a call fails, a message “Transfer Failed” displays, and you can reconnect the call (get the call back) by pressing the line key again.

- **Speed Dial/Xfer and Call Forward**
When the phone is in the “Ringing” state, pressing the Speed Dial/Xfer key forwards the call to the predefined extension.

Configuring a Speed Dial/Xfer Key



Aastra Web UI



Note: Keys 1 and 2 (SAVE and DELETE keys) can be made configurable ONLY by your System Administrator.

1. Click on **Operation->Programmable Keys**.
or
Click on **Operation->Expansion Module <N>**.

Key	Type	Value	Line
1	Save		global
2	Delete		global
3	Icom		global
4	Speeddial	9051234567+	1
5	XML	http://216.94.98.90/xml/menu/mymenu.php?source=	1
6	BLF/List		1

Services

XML Application URI:
XML Application Title:
BLF List URI:

Programmable Keys and Expansion Module Keys

2. Select from "**Key 3**" through "**Key 6**".
or
Select from "**Key 1**" through "**Key 36**" (M670i).
3. In the "**Type**" field, select **Speed Dial/Xfer**.
4. In the "**Value**" field, enter the speed dial extension or the extension to transfer calls to (for example, "**5551212**").
5. In the "**Line**" field, select the line for which you want to use the key functionality.
6. Click **Save Settings**.

Speed Dial/Conf

The 6753i allows you to configure a programmable key or expansion module key to be used as a speed dial conference key (**Speed Dial/Conf** key) while remaining in the current call. This key allows a user on a call to conference another party at a pre-defined number while remaining in the conference.

For example, while on an active call, a user can use the Speed Dial/Conf key to dial a recording service and have the resulting conference recorded.



Note: If not currently in a conference, the Speed Dial/Conf key is disabled on the active call.

If you configure a programmable key as a **Speed Dial/Conf** key and you press this key while on an active call, the focused line changes to the dialing line. A **Cancel** softkey displays on the phone allowing you to abort the conference speed dial if required. The message "*Ring...*" displays below the number when the far end is ringing. The message "*Conf. Unavailable*" briefly displays when a conference is already in progress. The active call is not put on hold when the speed dial number is dialed.



Note: This feature is not compatible with centralized conferencing.

Configuring a Speed Dial/Conf Key



Aastra Web UI



Note: Keys 1 and 2 (SAVE and DELETE keys) can be made configurable ONLY by your System Administrator.

1. Click on **Operation->Programmable Keys**.
or
Click on **Operation->Expansion Module <N>**.

Key	Type	Value	Line
1	Save		global
2	Delete		global
3	Icom		global
4	Speeddial	9051234567+	1
5	XML	http://216.94.98.90/xml/menu/mymenu.php?source=	1
6	BLF/List		1

Services

XML Application URI:
XML Application Title:
BLF List URI:

Programmable Keys and Expansion Module Keys

2. Select from "**Key 3**" through "**Key 6**".
or
Select from "**Key 1**" through "**Key 36**" (M670i).
3. In the "**Type**" field, select **Speed Dial/Conf**.
4. In the "**Value**" field, enter the number or the extension to add to the conference (for example, "**5551212**").
5. In the "**Line**" field, select the line for which you want to use the key functionality.
6. Click **Save Settings**.

Directory Key

By default, the 6753i has a Directory key configured on Key 3. However, using the Aastra Web UI, you can assign the Directory key to another available key if required (Key 3 through Key 6).

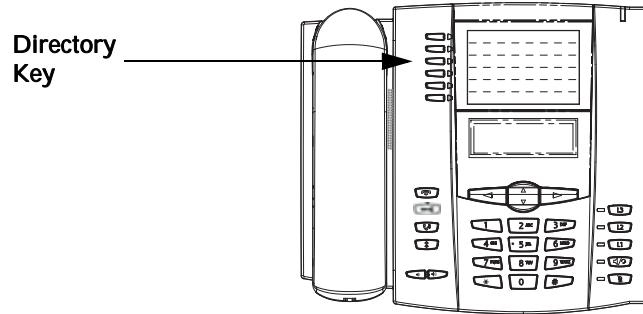

The "Directory List" feature allows you to store frequently used names and numbers on the phone. You can also dial directly from a directory entry.

You can use the Directory key to access a Directory List which contains a customized list of names with phone numbers and labels.

In addition to creating a Directory key, you can also download a Directory List to your PC if required using the Aastra Web UI.

Reference

For more information about the Directory List, see ["Directory List"](#) on [page 127](#).

Configuring a Directory Key



Aastra Web UI



Notes:

1. Keys 1 and 2 (SAVE and DELETE keys) can be made configurable ONLY by your System Administrator.
2. By default, the **Directory** key is Key 3.

Use the following procedure to configure a Directory key on the 6753i phone.

1. Click on **Operation->Programmable Keys**.
or
Click on **Operation->Expansion Module <N>**.

Key	Type	Value	Line
1	Save		global
2	Delete		global
3	Icom		global
4	Speeddial	9051234567+	1
5	XML	http://216.94.98.90/xml/menu/mymenu.php?source=	1
6	BLF/List		1

Services

XML Application URI:
XML Application Title:
BLF List URI:

Programmable Keys and Expansion Module Keys

2. Select from "**Key 3**" through "**Key 6**".
or
Select from "**Key 1**" through "**Key 36**" (M670i).
3. In the "**Type**" field, select **Directory**.
4. Click **Save Settings**.

Callers List Key

By default, the 6753i has a Callers List key configured on Key 4. However, using the Aastra Web UI, you can assign the Callers List key to another available key if required (Key 3 through Key 6).

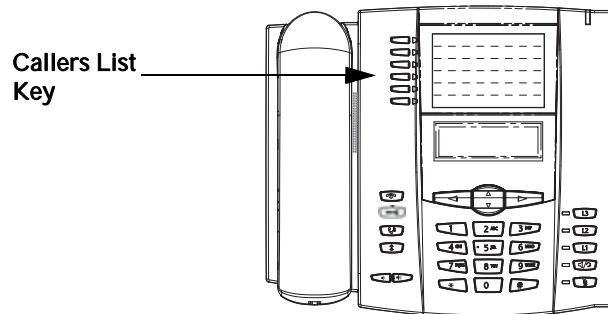

The Callers list is a stored log of your incoming calls. You can use the Callers List key to access a list of callers that called your phone.

Reference

For more information about the Callers List, see [“Callers List”](#) on page 137.

Configuring a Callers List Key



Aastra Web UI



Notes:

1. Keys 1 and 2 (SAVE and DELETE keys) can be made configurable ONLY by your System Administrator.
2. By default, the **Callers List** key is Key 4.

Use the following procedure to configure a Callers List key on the 6753i phone.

1. Click on **Operation->Programmable Keys**.
or
Click on **Operation->Expansion Module <N>**.

Key	Type	Value	Line
1	Save		global
2	Delete		global
3	Icom		global
4	Speeddial	9051234567+	1
5	XML	http://216.94.98.90/xml/menu/mymenu.php?source=	1
6	BLF/List		1

Services	
XML Application URI:	http://216.94.98.90/xml/menu/mymenu.php?source=
XML Application Title:	XML Menu
BLF List URI:	my9143i-blf-list@as.broadworks.com

Programmable Keys and Expansion Module Keys

2. Select from "**Key 3**" through "**Key 6**".
or
Select from "**Key 1**" through "**Key 36**" (M670i).
3. In the "**Type**" field, select **Callers List**.
4. Click **Save Settings**.

Transfer Key

By default, the 6753i has a Transfer key configured on Key 5. However, using the Aastra Web UI, you can assign the Transfer key to another available key if required (Key 3 through Key 6).

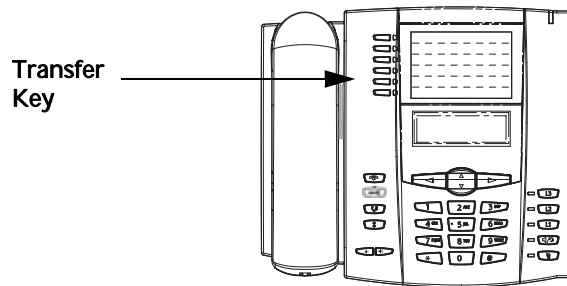

The Transfer key allows you to perform blind or consultative call transfers to other recipients. The blind transfer feature transfers a call to another number without you having to talk to the recipient. A consultative transfer feature transfers a call to another number but allows you to speak with the recipient before the call is actually transferred.

Reference

For more information about using blind and consultative call transfers, see [“Transferring Calls”](#) on page 118.

Configuring a Transfer Key



Aastra Web UI



Notes:

1. Keys 1 and 2 (SAVE and DELETE keys) can be made configurable **ONLY** by your System Administrator.
2. By default, the **Transfer** key is Key 5.

Use the following procedure to configure a Transfer key on the 6753i phone.

1. Click on **Operation->Programmable Keys**.
or
Click on **Operation->Expansion Module <N>**.

Key	Type	Value	Line
1	Save		global
2	Delete		global
3	Icom		global
4	Speeddial	9051234567+	1
5	XML	http://216.94.98.90/xml/menu/mymenu.php?source=	1
6	BLF/List		1

Services

XML Application URI:
XML Application Title:
BLF List URI:

Programmable Keys and Expansion Module Keys

2. Select from "Key 3" through "Key 6".
or
Select from "Key 1" through "Key 36" (M670i).
3. In the "Type" field, select **Transfer**.
4. Click **Save Settings**.

Conference Key

By default, the 6753i has a Conference key configured on Key 6. However, using the Aastra Web UI, you can assign the Conference key to another available key if required (Key 3 through Key 6).

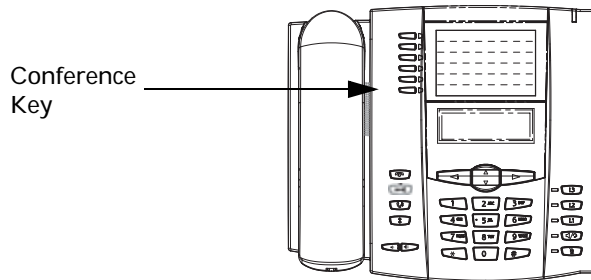

The Conference key allows you to link three active calls into a single conference (Local Conferencing). This key also helps to create multiple conferences with unlimited participants on your phone if your System Administrator has enabled Centralized Conferencing on your phone.

Reference

For more information about Local and Centralized Conferencing, see “[Conferencing Calls](#)” on page 121.

Configuring a Conference Key



Aastra Web UI



Notes:

1. Keys 1 and 2 (SAVE and DELETE keys) can be made configurable ONLY by your System Administrator.
2. By default, the **Conference** key is Key 6.

Use the following procedure to configure a Conference key on the 6753i phone.

1. Click on **Operation->Programmable Keys**.
or
Click on **Operation->Expansion Module <N>**.

Key	Type	Value	Line
1	Save		global
2	Delete		global
3	Icom		global
4	Speeddial	9051234567+	1
5	XML	http://216.94.98.90/xml/menu/mymenu.php?source=	1
6	BLF/List		1

Services	
XML Application URI:	http://216.94.98.90/xml/menu/mymenu.php?source=
XML Application Title:	XML Menu
BLF List URI:	my9143i-blf-list@as.broadworks.com

Programmable Keys and Expansion Module Keys

2. Select from "Key 3" through "Key 6".
or
Select from “Key 1” through “Key 36” (M670i).
3. In the "Type" field, select **Conference**.
4. Click **Save Settings**.

Intercom Key

By default, the IP phone allows incoming intercom calls to be automatically answered without having to set up an Icom key on your phone. For more information about changing the behavior of incoming Intercom calls, see the section “[Incoming Intercom Call Features](#)” on [page 184](#).

Your System Administrator can enable outgoing intercom calls on your phone. If enabled, you must configure an Icom key on your phone to use for outgoing intercom calls. You must configure a programmable key or expansion module key with the function, “**Intercom**”.

Use the following procedure to configure a key as an Icom key using the Aastra Web UI.

Configuring an Intercom Key

 **Aastra Web UI**

 **Note:** Keys 1 and 2 (SAVE and DELETE keys) can be made configurable ONLY by your System Administrator.

1. Click on **Operation->Programmable Keys**.
or
Click on **Operation->Expansion Module <N>**.

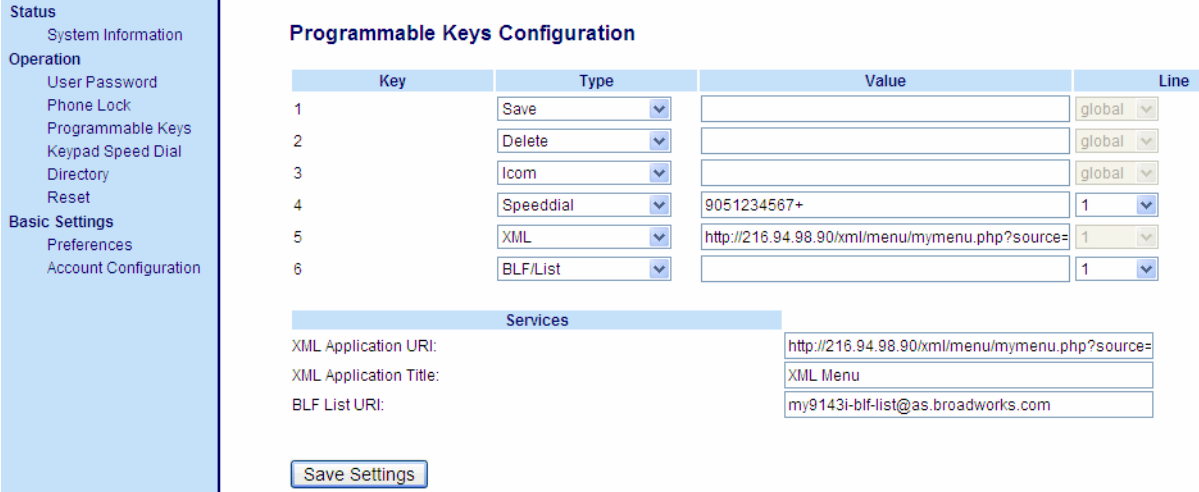

Key	Type	Value	Line
1	Save		global
2	Delete		global
3	Icom		global
4	Speeddial	9051234567+	1
5	XML	http://216.94.98.90/xml/menu/mymenu.php?source=	1
6	BLF/List		1

Services

XML Application URI:
XML Application Title:
BLF List URI:



Programmable Keys and Expansion Module Keys

2. Select from "Key 3" through "Key 6".
or
Select from “**Key 1**” through “**Key 36**” (M670i).
3. In the "Type" field, select **Intercom**.
4. Click **Save Settings**.

Using the Icom Key (for Outgoing Intercom Calls)



IP Phone UI

1. Press the **Icom** key.
2. Enter the extension number of the person you want to intercom or the BLF key for that extension.
3. After a beep tone, your phone automatically connects with the remote extension and you can speak through its speaker.
4. To cancel intercom, press  or hang up the handset.
5. When you are finished speaking, hang up the phone by placing the handset back on-hook or by pressing  or the line/call appearance button for the active call. When you hang up, the remote phone also hangs up.

Reference

For more information about incoming intercom calls, see [“Incoming Intercom Call Features”](#) on [page 184](#). For more information about outgoing intercom calls, see [“Available Features Enabled by Administrators”](#) on [page 193](#).

Services Key

The 6753i allows you to configure a Services key that, when pressed on the phone, displays the Services menu which includes the following options:

- Directory (See “[Directory List](#)” on [page 127](#) for more information.)
- Callers List (See “[Callers List](#)” on [page 137](#) for more information.)
- Voicemail (See “[Voicemail](#)” on [page 164](#) for more information.)

The Services Menu can also be accessed via the IP Phone UI at the location, *Options->Services*. The Services key can also access any XML applications setup by your System Administrator. Contact your System Administrator for more information.

To configure a Services key, you must configure a key with the function, “**Services**”.

Use the following procedure to configure a key as a Services key using the Aastra Web UI.

Configuring a Services Key

 **Aastra Web UI**

 **Note:** Keys 1 and 2 (SAVE and DELETE keys) can be made configurable ONLY by your System Administrator.

1. Click on **Operation->Programmable Keys**.
or
Click on **Operation->Expansion Module <N>**.

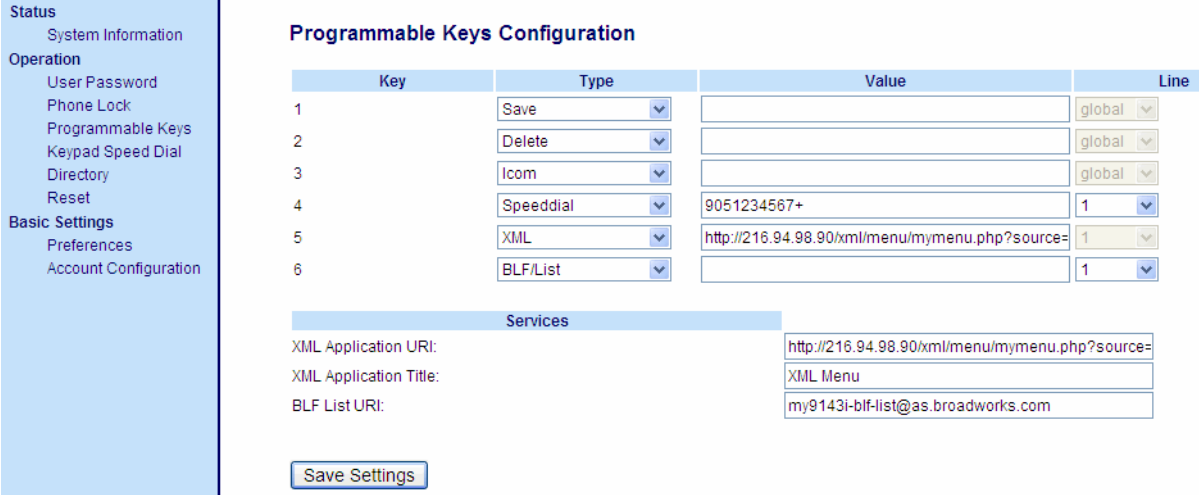

Key	Type	Value	Line
1	Save		global
2	Delete		global
3	Icom		global
4	Speeddial	9051234567+	1
5	XML	http://216.94.98.90/xml/menu/mymenu.php?source=	1
6	BLF/List		1

Services

XML Application URI:
XML Application Title:
BLF List URI:

Programmable Keys and Expansion Module Keys

2. Select from "**Key 3**" through "**Key 6**".
or
Select from "**Key 1**" through "**Key 36**" (M670i).
3. In the "**Type**" field, select **Services**.
4. Click **Save Settings**.

Using the Services Key



IP Phone UI

1. Press the **Services** key. The following default list displays:
 - Directory (See "[Directory List](#)" on [page 127](#) for more information.)
 - Callers List (See "[Callers List](#)" on [page 137](#) for more information.)
 - Voicemail (See "[Voicemail](#)" on [page 164](#) for more information.)



Note: Additional options may display in the Services Menu if setup by your System Administrator. Contact your Administrator for more information.

2. Select an option from the Services Menu.
3. To cancel a Service, press  .

Phone Lock Key

You can configure a programmable key or an expansion module key on the phone to use as a lock/unlock key. You assign the function of the key as “**Phone Lock**”.

Use the following procedure to configure a key as a lock/unlock key in the Aastra Web UI.

Configuring a Phone Lock Key



Aastra Web UI



Note: Keys 1 and 2 (SAVE and DELETE keys) can be made configurable ONLY by your System Administrator.

1. Click on **Operation->Programmable Keys**.
or
Click on **Operation->Expansion Module <N>**.

Key	Type	Value	Line
1	Save		global
2	Delete		global
3	Icom		global
4	Speeddial	9051234567+	1
5	XML	http://216.94.98.90/xml/menu/mymenu.php?source=	1
6	BLF/List		1

Services

XML Application URI:
XML Application Title:
BLF List URI:

Programmable Keys and Expansion Module Keys

2. Select from "Key 3" through "Key 6".
or
Select from “**Key 1**” through “**Key 36**” (M670i).
3. In the "Type" field, select **Phone Lock**.
4. Click **Save Settings**.



Note: You can lock/unlock the phone using the new key you just configured, using the Aastra Web UI at the path *Operation->PhoneLock*, or using the “**Phone Lock**” option on the IP Phone UI at the path *Options->Phone Lock*. For more information about using the lock/unlock feature, see “**Phone Lock**” on page 46.

Using the Lock/Unlock Key on the IP Phone

After configuring a key as a lock/unlock key, refer to the following procedure to use the key on the IP phone.



IP Phone UI

Lock the Phone

1. Press the **Lock** key.
The phone locks.
The LED for the key AND the Message Waiting Lamp illuminate steady ON. An “**Unlock**” label appears next to the key you just pressed.

Unlock the Phone

1. Press the **Unlock** key.
A password prompt displays.
2. Enter your user password and press **ENTER**.
The phone unlocks.
The LED for the key AND the Message Waiting Lamp go OFF. The “**Lock**” label appears next to the key you just pressed.

Paging Key (Sends the RTP Stream)

You can configure a Paging key on the phone that allows you to send a Real Time Transport Protocol (RTP) stream to pre-configured multicast address(es) without involving SIP signaling. You enter a multicast IP address(es) and a port number for the Paging key, that when pressed, initiates an outgoing multicast RTP session. This is called Group Paging on the IP phones.

You can also specify group paging RTP addresses that the phone listens for when receiving RTP streams. You can specify up to 5 listening multicast addresses at the path, *Basic Settings->Preferences->Group Paging RTP Settings*.

For more information about Group Paging and how it works, and to specify multicast addresses, see “[Group RTP Paging \(receives RTP streams\)](#)” on page 188.

Configuring a Paging Key

 **Aastra Web UI**

 **Note:** Keys 1 and 2 (SAVE and DELETE keys) can be made configurable ONLY by your System Administrator.

1. Click on **Operation->Programmable Keys**.
or
Click on **Operation->Expansion Module <N>**.

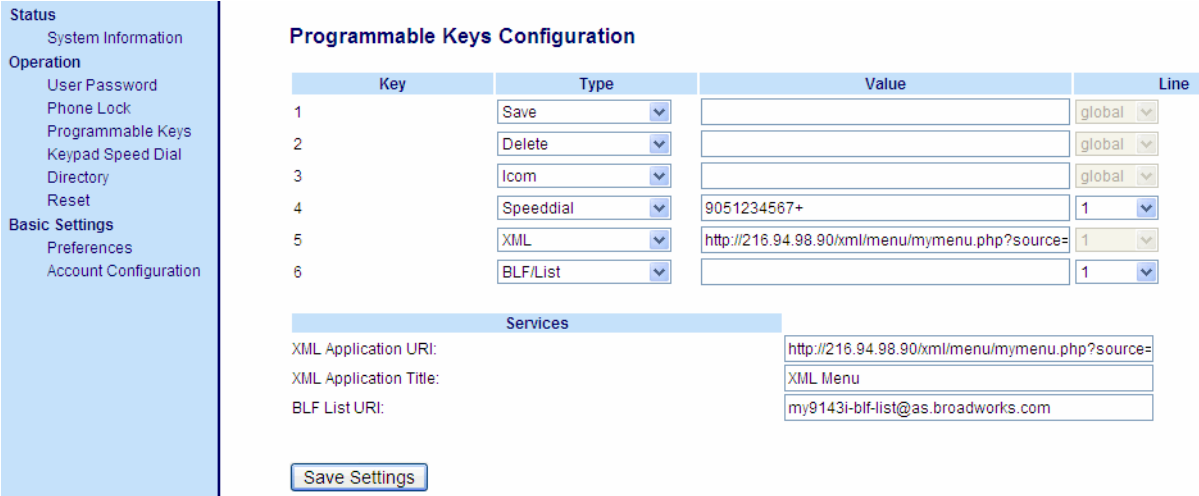

Key	Type	Value	Line
1	Save		global
2	Delete		global
3	Icom		global
4	Speeddial	9051234567+	1
5	XML	http://216.94.98.90/xml/menu/mymenu.php?source=	1
6	BLF/List		1

Services

XML Application URI:
XML Application Title:
BLF List URI:

Programmable Keys and Expansion Module Keys

2. Select from "Key 3" through "Key 6".
or
Select from “Key 1” through “Key 36” (M670i).
3. In the "Type" field, select **Paging**.

4. In the “**Value**” field, enter a multicast IP address and a port number for the Paging key. When you press this key, the phone initiates an outgoing multicast RTP session to the specified address using the specified port. (For example, 239.0.1.15:10000).



Note: The “Value” field allows for one multicast address entry only.

5. To receive RTP streams for Group Paging, you must also configure the "**Paging Listen Addresses**" parameter at the path, *Basic Settings->Preferences->Group Paging RTP Settings*. For more information about setting this parameter, see “[Group RTP Paging \(receives RTP streams\)](#)” on [page 188](#).
6. Click **Save Settings**.

Using the Paging Key

The following procedure describes the use of the Paging key on the IP Phone. The procedure assumes you have already configured the Paging key using the Aastra Web UI.



IP Phone UI



Notes:

1. Recipient of a Paging call can set a global “Do Not Disturb” (DND) to ignore any incoming pages.
 2. For incoming Paging, the phone uses the Intercom configuration settings. The incoming Page is dependant on the “Allow Barge-In” parameter setting and the “Idling/On Call” state.
-

1. On the IP Phone, press the key you configured for Paging. The phone opens a multicast RTP session and an outgoing OR incoming phone screen displays as follows:

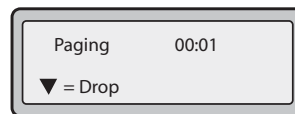

2. Press the **Drop** key to end the multicast RTP session and return to the idle screen.
-



Note: If you enable global DND on the phone, the incoming multicast RTP session is dropped.

None Key

You can set a key to force a blank entry on the IP phone display for a specific key. You do this by setting the key to "none". If a particular key is not defined, it is ignored.

Setting a None Key



Aastra Web UI



Note: Keys 1 and 2 (SAVE and DELETE keys) can be made configurable ONLY by your System Administrator.

Use the following procedure to configure a None key on the 6753i IP Phone.

1. Click on **Operation->Programmable Keys**.
or
Click on **Operation->Expansion Module <N>**.

Key	Type	Value	Line
1	Save		global
2	Delete		global
3	Icom		global
4	Speeddial	9051234567+	1
5	XML	http://216.94.98.90/xml/menu/mymenu.php?source=	1
6	BLF/List		1

Services

XML Application URI: http://216.94.98.90/xml/menu/mymenu.php?source=

XML Application Title: XML Menu

BLF List URI: my9143i-blf-list@as.broadworks.com

Programmable Keys and Expansion Module Keys

2. Select from "Key 3" through "Key 6".
or
Select from "Key 1" through "Key 36" (M670i).
3. In the "Type" field, select **None**.
4. Click **Save Settings**.

Deleting a Key

 **Aastra Web UI**

 **Note:** Keys 1 and 2 (SAVE and DELETE keys) can be made configurable ONLY by your System Administrator.

Use the following procedure to delete a key function using the Aastra Web UI.

1. Click on **Operation->Programmable Keys**.
or
Click on **Operation->Expansion Module <N>**.

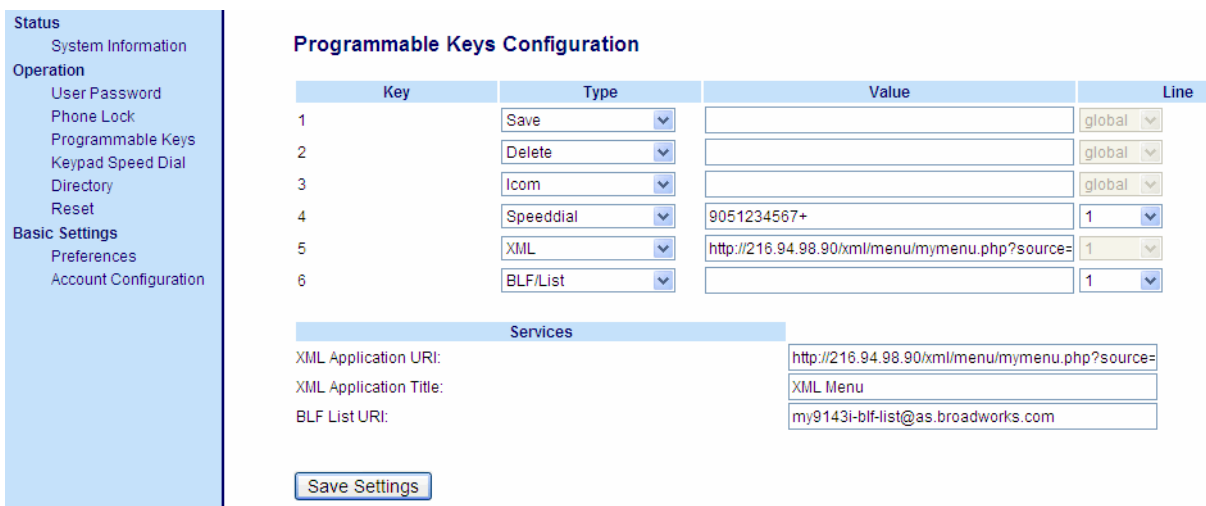

Key	Type	Value	Line
1	Save		global
2	Delete		global
3	Icom		global
4	Speeddial	9051234567+	1
5	XML	http://216.94.98.90/xml/menu/mymenu.php?source=	1
6	BLF/List		1

Services

XML Application URI: http://216.94.98.90/xml/menu/mymenu.php?source=

XML Application Title: XML Menu

BLF List URI: my9143i-blf-list@as.broadworks.com

Programmable Keys and Expansion Module Keys

2. Select from "Key 3" through "Key 6".
or
Select from "Key 1" through "Key 36" (M670i).
3. In the "Type" field, select **None**.
4. Click **Save Settings**.

The function is deleted from the IP phone memory.

Making Calls

This section describes ways to make calls on your 6753i phone, using your handset, speakerphone or headset.

Dialing a Number

First, take the phone off-hook by:

- lifting the handset
- pressing  or
- pressing a line/call appearance button.

At the dial tone, enter the number you wish to call.



Note: After dialing the number, the phone has a short delay before sending the call. To send the call immediately, you can press the "#" key immediately after dialing the number. The phone sends the call without delay.

If you are unable to make calls within certain area codes, check with your System Administrator for any toll restrictions placed on your extension that may restrict your access to long distance area codes or dialing prefixes.

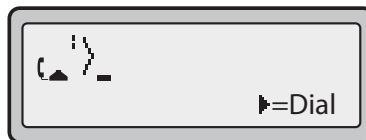

When your party picks up, a timer appears on your display that records the length of your call.



If the Live DialPad option is on, as soon as you press the first digit on the dial pad the phone automatically selects the next available line, go off-hook and dial as digits are pressed.



Using Handsfree Speakerphone

The handsfree feature allows you to speak to someone without using the handset or headset. Your phone must be in either the Speaker or Speaker/Headset audio mode. For more information about setting the audio mode on your phone, see [“Set Audio” on page 29](#).



IP Phone UI

- To dial using handsfree, first press  and enter a number at the dial tone.
- To answer a call on your phone using handsfree, press  or the line/call appearance button.

- If you are in Speaker audio mode, lift the handset and press  to switch between handsfree and handset.
- If you are in Speaker/headset audio mode, press  to switch between handsfree and headset.
- When the handset is on hook, press  to disconnect the call.

When handsfree is on, the speaker light turns on.

Using a Headset

The 6753i accepts headsets through the modular RJ9 jack on the back of the phone. Contact your telephone equipment retailer or distributor to purchase a compatible headset.



Note: Customers should read and observe all safety recommendations contained in headset operating guides when using any headset.

Advanced Volume Controls for the Headset Mic

On the 6753i, there are 3 options for the headset microphone volume. For more information about the headset microphone, see [“Headset Mic Volume”](#) on [page 29](#).



IP Phone UI

To change the volume:

1. Press  to enter the Options list.
2. Select **Preferences** and press 4.
3. Use 2 to scroll down to **Set Audio** and press 4 to select.
4. Press 2 to scroll down to **Headset/Mic Volume** and press 4 to select.
5. Use 2 to scroll down the list and press 4 to select your desired volume.
6. Press 4 to save changes and 3 to exit.
7. If you do not wish to save changes, press 3 to return to the previous screen.





Note: By default, the volume for the headset microphone is set to medium.

Making and Receiving Calls Using a Headset





IP Phone UI

1. Ensure that you have selected a headset audio mode by accessing the Options list (under option **Preferences->Set Audio->Audio Mode** on the IP Phone).
2. Plug the headset into the jack.
3. Press the  key to obtain a dial tone or to answer an incoming call. Depending on the audio mode selected from the options menu, a dial tone or an incoming call is received on either the headset or the handsfree speakerphone.
4. Press the  key to end the call.

Redial



IP Phone UI

- Press  to dial the most recent number you dialed from the phone.
- If you are off-hook and press  the last number you called is called back.
- If you are on-hook and press , a **Redial Directory** list appears on-screen.

The redial list is available during active calls. It stores up to the last 100 numbers you called, allowing you to scroll through and select the number you wish to redial.







Note: Your System Administrator can set your Redial key to speed dial a specific number. Contact your System Administrator for more information.

Accessing the Redial List



IP Phone UI

1. If you are off-hook and press , the telephone automatically dials the last number you called.
2. If you are not on the phone, press  to display the most recently dialed number and use 2 and 5 to scroll through the list to view the other numbers.
3. Press 2 to see the second most recently dialed number, or 5 to see the oldest call on your list.
4. To dial the displayed number press , or lift the Handset or press any line keys.
5. Press  or the  key to cancel.



Note: The redial list is available during active calls. It also stores up to the last 100 numbers you called, allowing you to scroll through and select the number you wish to redial.

Deleting from the Redial List



Note: You cannot delete individual entries in the Redial List.



IP Phone UI

Delete All Items

1. Press .
2. Press the **Delete** Key, then press the **Delete** Key again at the prompt to erase all items.

DELETE again to
erase all items

Redial List is
empty

Mute

You can use the Mute  key to mute the handset, headset, or speakerphone. When you use the mute key on your phone, you cannot be heard on an active call or on a conference.

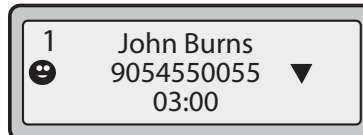

When a call is muted, the icon displays as follows.



For muted calls, the handsfree LED flashes and the Mute key LED is ON.



IP Phone UI

Press the  button at any time to mute handset, headset, or handsfree. The speaker light flashes slowly and you can hear the caller, but they cannot hear you. To switch mute on or off, press .



Note: If you place a muted call on hold, the phone automatically takes the call off mute when you reconnect to the call.

Receiving Calls



When a call is ringing at your extension, you see the "Inbound Call" Screen. The line/call appearance light flashes quickly for the incoming call.



Answering an Incoming Call



To answer the call

- For handsfree operation, press  or the line/call appearance button for the incoming call.
- Press  for handsfree or headset operation.



Note: The audio mode setting you have selected in the options list under *Set Audio->Audio Mode* determines if the call goes to handsfree or headset operation. For more information, see "[Set Audio](#)" on [page 29](#).

- Lift the handset for handset operation.



If the phone is already connected to a call, pressing the line/call appearance button for the new incoming call automatically places the connected call on hold and answers the new call. To reconnect to a party, press the line/call appearance button for that call.

If you cannot answer the call, the caller goes to voicemail has been configured for your extension.



Note: The  button can be used to cancel the call pickup procedure.

Sending an Incoming Call to Voicemail

You can send an incoming call directly to voicemail without answering the call. To do this, press  without picking up the handset. If you're already on the phone your incoming call should go directly to voicemail. Your phone screen displays a voicemail icon () along with the number of waiting messages, if you have unheard messages (example:  x4).

Handling Calls

When you are connected to a call, you can use the hard keys or programmable keys on the phone to place a call on hold, transfer a call, or conference.

Placing a Call on Hold

You can place an active call on hold by pressing the Hold  key. When you place a call on hold, only your phone can retrieve the call.

When a call is on hold, the icon displays on-hook as follows.

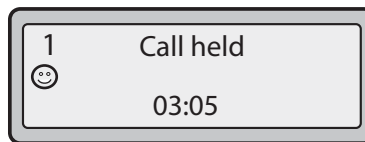

For on-hold calls, the timer displays as running and the Line and main LEDs flash.



IP Phone UI

To place a call on hold

1. Connect to the call (if not already connected).
2. Press the Hold  key.

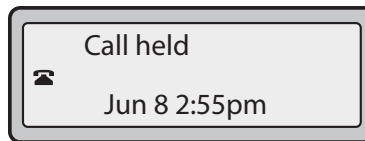

The line/call appearance light begins to flash slowly and after a short time the phone beeps softly to remind you that you still have a call on hold. The screen displays "**Call Held**" with the line number the call is held at the phone.



Note: If you are connected to another call, the phone does not beep to remind you that you still have a call on hold.

When on Hold

To let your caller know that they are still on hold, music plays softly (if this has been set up for your system). The call/line appearance light for the line you are on remains solid to indicate that you are still connected.

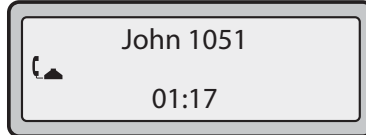

Automatic Hold

When juggling between calls, you do not have to press the hold button to go from one call to the next. The phone automatically puts your current call on hold as soon as you press a new line/call appearance button. If you have more than one call on hold, you can reconnect to a held call by pressing the line/call appearance button where that call is being held. Press  to disconnect the call.

Retrieving a Held Call

If you have more than 1 call on hold, you can scroll through the held call information by pressing 3 and 4 navigation keys. To reconnect to a call press the line/call appearance button where that call is being held. If you press the call/line appearance button again, you disconnect from the call.

Transferring Calls

Blind Transfer

A blind transfer is when you transfer a call directly to another extension without consulting with the person receiving the call. To do this, simply complete the transfer immediately after you have entered the number. The call goes directly to the extension or outside line you transferred to. If the party you are transferring the call to does not answer, the transferred call rings back to your extension.

Consultive Transfer

You also have the option to consult with the person you are transferring the call to, before you complete the transfer. To do this, remain on the line until the receiving party answers the call. After consulting with the receiving party, you can either complete the transfer or cancel the transfer to go back to the original call.



Use the following procedure to transfer a call to another extension. Use the following illustration as a reference.

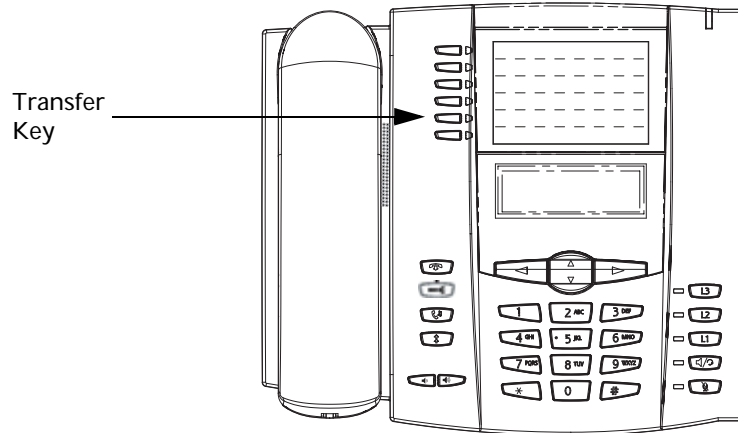

1. Connect to Party 1 (if not already connected). Party 1 is the party you want to transfer.
2. Press the **Transfer** Key. You should hear a dial tone as a second line opens up.
3. Dial the extension number (or the outside number) to Party 2. This is the Party for which you want to transfer Party 1.
4. To complete a "blind" transfer, press the **Transfer** Key again before the receiving end answers. To complete a consultive transfer, remain on the line to speak with the Party 2, before pressing the **Transfer** Key again to transfer Party 1 to Party 2. To cancel the transfer, select **Cancel** on the display screen.

Transferring Two Existing Calls

The 6753i allows you to perform a transfer of a call when there are currently two active calls on the phone. For example, on your phone, there are two active calls - Call A and Call B. Call B is on hold. You can perform the following to transfer Call A to Call B:

1. Press **Xfer** key. A new line opens.
2. Press or scroll to the **Line** where Call B is on hold.
3. Press **Xfer** key.

Call A is transferred to Call B.

Indication of Transferred Calls

When you transfer an active call, the near-end phone displays a “Call Transferred” screen when a call is transferred and the far-end call is dropped. An audible busy signal is also heard on the phone. The following is the “Call Transferred” screen on the 6753i phone:

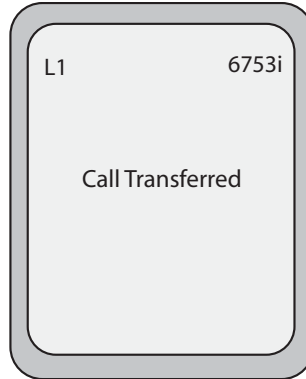

Conferencing Calls

The 6753i IP phone offers two methods of conferencing:

- Local conferencing (default method).
- Centralized conferencing (for Sylanro and Broadsoft Servers) (Administrator must enable this method).

By default, the **Conference** key is Key 6 on your phone. A Conference key must be set up on your phone before you can set up conference calls. To assign a key as a Conference key, see [“Conference Key”](#) on page 100.

Conference State Screens

When you use the Conference key to initiate a conference call, the following screen displays.



In a conference call, the call timer moves to the left. You use the up and down arrow keys to scroll to a party on the list. You use the right arrow key to select the party to drop.

Local Conferencing

The 6753i phone supports up to 3 parties (including yourself) in a conference call. This is called Local Conferencing and is the default method of conferencing on the 6753i.



Note: Your System Administrator can set your Conference key to speed dial a specific number. Contact your System Administrator for more information.

Using Local Conferencing



Use the following procedure to create a conference call using local conferencing. Use the following illustration as a reference.

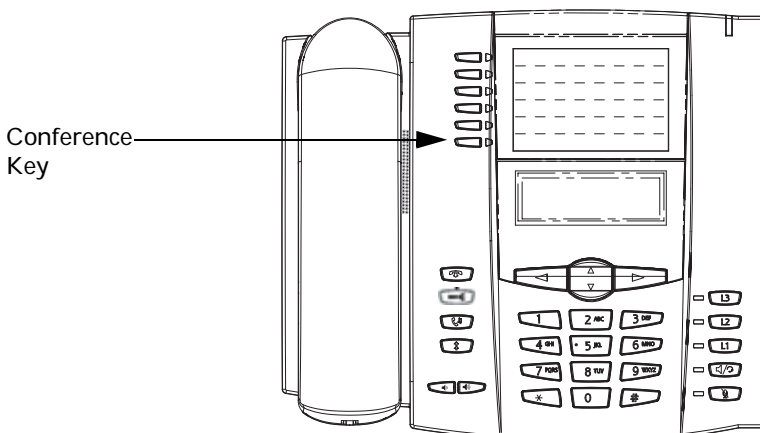

1. When you begin a conference, you are the first party in the conference (Party 1). Pick up the handset or press the speakerphone key. A line opens up.
2. Call Party 2 by dialing their number (or answer an incoming call of a Party).
3. Wait for Party 2 to answer. When Party 2 answers, you can consult with them before adding them to the conference.
4. Press the **Conf** Key. A new line opens.

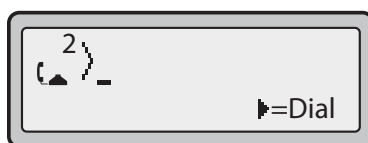

5. Enter the phone number of Party 3.
6. Wait for Party 3 to answer. When Party 3 answers, you can consult with them before adding them to the conference.
7. Press the **Conf** key again to add Party 3 to the conference. Party 1 (which is yourself), Party 2, and Party 3 are all connected to a single conference.
8. To drop a party from the conference, press the **Conf** key once more.



Note: You can use 2 and 5 to scroll through and see the numbers and names (if available) of the parties in the conference call. When a name is displayed, pressing 4 drops the displayed party from the call.

Joining Two Active Calls in a Single Conference



IP Phone UI

1. Begin with active calls on two different lines (for example, Line 1 and Line 2 have active calls).
2. Press the **Line** key for which you want to conference the two calls together (for example, Line 1).
3. Press the **Conf** key.
4. Press the **Line** key that has the second active call (for example, Line 2).
5. Press the **Conf** key. The two active calls link into a conference call on Line 1.



Note: You can use 2 and 5 to scroll through and see the numbers and names (if available) of the parties in the conference call. When a name is displayed, pressing 4 drops the displayed party from the call.

Centralized Conferencing (for Sylanro and Broadsoft Servers)

The 6753i allows you to create multiple conferences with unlimited participants (depending on your server limitations) when your Administrator enables Centralized Conferencing.

If your Administrator does not enable Centralized Conferencing, then the 6753i uses Local Conferencing by default.

Your Administrator can configure Centralized Conferencing globally on all lines or on specific lines. Although, for the global setting to work, you must configure the lines with the applicable phone number.

Reference

For more information on Centralized Conferencing, see [“Centralized Conferencing”](#) on page 195 or contact your System Administrator.

Using Centralized Conferencing



IP Phone UI



Note: When Centralized Conferencing is enabled on your phone, local conferencing (or three-way conferencing) works as indicated in the previous section, “[Using Local Conferencing](#).” Joining two active calls in a conference also works as indicated in the previous section, “[Joining Two Active Calls in a Single Conference](#).”

Use the following procedure to create a conference call using centralized conferencing. Use the following illustration as a reference.

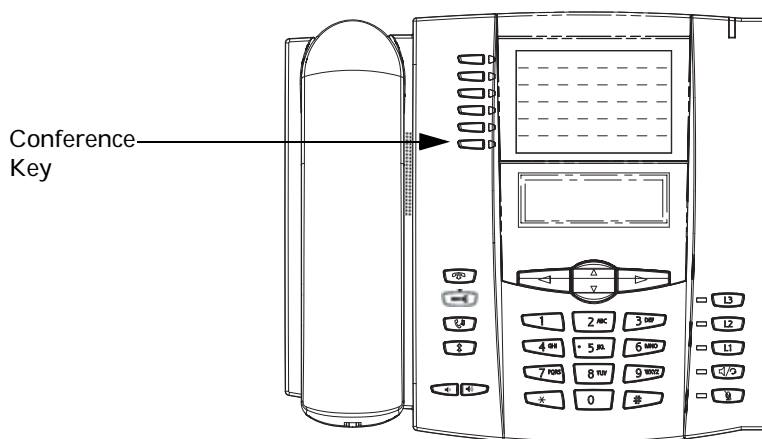

Setting Up a Conference and Adding Multiple Parties (for Sylantro and Broadsoft Servers)



Note: You can have an unlimited number of parties in a conference (dependent on the limitations of the server).

1. When you begin a conference, you are the first party in the conference (Party 1). Pickup the handset or press the Speakerphone Key. A line opens up.
2. Call Party 2 by dialing their number (or answer an incoming call of a Party).
3. Wait for Party 2 to answer. When Party 2 answers, you can consult with them before adding them to Conference 1.
4. Press the **Conf** Key. A new line opens.

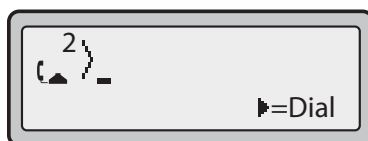

5. Enter the phone number of Party 3.

6. Wait for Party 3 to answer. When Party 3 answers, you can consult with them before adding them to the Conference 1.
7. Press the **Conf** Key again to add Party 3 to Conference 1. Party 1 (which is yourself), Party 2, and Party 3 are all connected to Conference 1.
8. Press an available **Line** Key (or answer an incoming call on an available line). If calling out, call Party 4.
9. Wait for Party 4 to answer. When Party 4 answers, you can consult with them before adding them to the conference.
10. Press the **Conf** Key to add Party 4 to Conference 1.
11. Press the **Line** Key that has Conference 1.
12. Press the **Conf** Key to join all parties (Parties 1 through 4) on Conference 1.
13. To add more parties, repeat steps 8 through 12.



Note: You can use 2 and 5 to scroll through and see the numbers and names (if available) of the parties in the conference call. When a name is displayed, pressing 4 drops the displayed party from the call.

If any party in the conference hangs up (including the party that began the conference), all other parties in the conference are still connected.

Setting Up Multiple Conferences (for Sylanro Server only)



Note: The 6753i is limited to 9 conferences (a single conference each on lines 1 through 9).

1. Start Conference 1 using the procedures in the previous section, [“Setting Up a Conference and Adding Multiple Parties \(for Sylanro and Broadsoft Servers\)”](#).
2. When you are finished adding all required parties to Conference 1, press an available **Line** Key to start Conference 2. You are Party 1 on Conference 2. Call Party 2.
3. When Party 2 answers, press the **Conf** Key.
4. Press an available **Line** Key.
5. Call Party 3 for Conference 2.
6. When Party 3 answers, press the **Conf** Key to join Parties 1 (which is yourself), Party 2, and Party 3 on Conference 2.
You now have two active conferences on two different lines.



Note: When you are connected to multiple conference calls, and you put a conference on hold, the conference may be on hold for a limited period of time before it is disconnected. Contact your System Administrator for more information.

If any party in a conference hangs up (including the party that began the conference), all other parties in the conference are still connected.

Joining Additional Parties to Active Conferences

In centralized conferencing, you can join multiple incoming or outgoing calls to active conferences. Before following this procedure, at least one active conference must exist on your phone.

1. As Party 1, pickup the handset or press the speakerphone key.
A line opens up.
2. Call Party 2 by dialing their number (or answer an incoming call of a Party).
3. Wait for Party 2 to answer. When Party 2 answers, you can consult with them before adding them to the conference.
4. Press the **Conf** Key.
5. Press the **Line** Key that has the active conference. (For example, Line 1 and Line 2 both have active conferences. Pressing Line 1 joins Party 1 and Party 2 to the conference on Line 1. Pressing Line 2 joins Party 1 and Party 2 to the conference on Line 2.)
6. Press the **Conf** Key again to join the Parties to the active conference.

Ending a Conference and Transferring Remaining Parties

The 6753i allows a Host to drop from a 3-way conference and let the other two parties remain connected by pressing a **Xfer** key.



Notes:

1. The 6753i does not support scrolling between lines.
 2. The Caller ID of the dropped Host still displays on the remaining parties' phones.
-

If you are the Host of a conference and want to leave that conference:

- While in a 3-way conference press the **Xfer**  key on the phone.

Your phone leaves the 3-way conference but the remaining parties are still connected to the conference.

Ending Calls



IP Phone UI

To end a call, you first need to connect or reconnect to the call if not already connected (for example, if your caller is on hold). Press  or the line/call appearance button of the active call to end the call. If connected through the handset, you can also place the handset back on hook to end the call.

Managing Calls

The 6753i has several features that make it easier to manage calls, and to keep track of your caller history, as well as your business and personal contacts.

These features include:

- Directory List
- Callers List
- Call Forwarding
- Missed Calls Indicator
- Voicemail

Directory List

The Directory List is your personal phone book, conveniently stored within your phone. You can enter up to 200 entries into the 6753i Directory by adding them manually, or by saving the number and name from other lists stored on your phone. You can also dial directly from a directory entry. Each entry can contain a maximum of 16 letters and numbers. On the 6753i, you access the Directory by pressing the **Directory Key (Key 3)**.

Accessing Your Directory



IP Phone UI

Use the following procedure to access your Directory List. Use the following illustration as a reference.

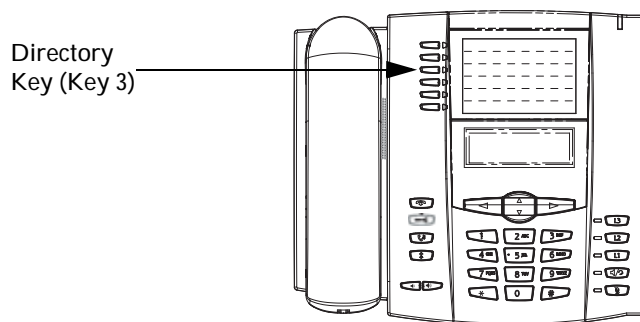

1. Press the **Directory Key (Key 3)**. The directory displays the number of entries in your list. If the Directory list is empty, "*Directory Empty/Use Save to add*" is displayed.

Directory empty
Use Save to add

2. You can access entries by pressing 2 and 5 to scroll through the list.
3. To search for an entry by name, press the dial pad number corresponding to the first letter of the name (for example, press **7** for the letter **P**). Continue to press the dial pad number to access other letters on the same key (for example, press **7** three times for 'Ron'). If there are multiple entries under the same letter, you can use 2 and 5 to scroll through the list, or continue to press the next letters of the name to find a better match.
4. To dial the displayed number press  or just lift the handset or press any Line Key.
5. Press the **Directory Key** to cancel.

Sorting Entries and Quick Search Feature

You can also sort multiple numbers according to preference and perform a quick-search feature that allows you to enter the first letter that corresponds to a name in the Directory to find specific line items. The phone displays the first name with this letter.



Note: The quick-search feature in the Directory List works only when the Directory is first accessed.

Managing the Directory List

From the Directory List in the IP Phone UI, you can perform the following:

- [“Add a New Entry to the Directory List” \(page 129\)](#)
- [“Edit an Entry in the Directory List” \(page 131\)](#)
- [“Delete an Entry from the Directory List” \(page 132\)](#)
- [“Save an Entry to the Directory List” \(page 133\)](#)

Add a New Entry to the Directory List



IP Phone UI

Use the following procedures to add a new entry to the Directory List. Use the following illustration as a reference.

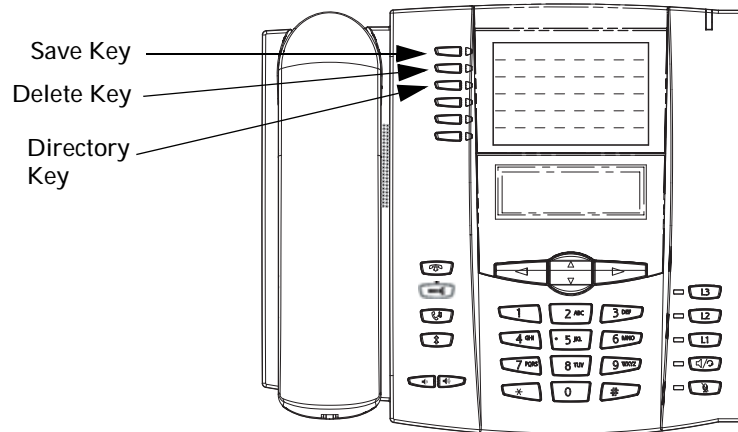

Notes:

1. Use the 3 Key when required for backspacing.
2. You can exit the entry process any time by pressing the  Key.

1. Press the **Directory** Key (Key 3).
2. Press **Save** (Key 1).
The "*Enter Number*" prompt displays.
3. Enter a phone number using the numbers on the keypad and press **Save**. To backspace and erase a mistake, press 3 or press the **Delete** Key (Key 2).
The "*Press 1st letter to enter name*" prompt displays.
4. Enter a name to associate with the phone number you just entered, and press **Save**. Use the keypad to select the letters. Continue to press the number key to access the next letter for that key (for example, press 2 three times to access C). Press 4 to move to the next space, or wait a moment and the cursor automatically advances. To insert a space between letters, press 4. To backspace and erase a mistake, press 3 or press the **Delete** Key.
The "*Line*" prompt displays. The default is **Line 1**.
5. If you want to save the new Directory entry to use Line 1, press **Save** to save the new entry to the Directory List.
If you want the new entry to use a different line, use the 2 key to select a different Line and press **Save**.
The new entry you added is saved to the Directory List.

Saved: Directory
John Burns

Adding an Entry to the Directory List from the Save Key

You can also add a new entry to the Directory List from the **Save Key** (Key 1).



Notes:

1. Use the **3** Key when required for backspacing.
 2. You can exit the entry process any time by pressing the  Key or the **Directory Key**.
-

1. Press the **Save Key**.
The "Save to?" prompt displays.
2. Press the **Directory Key**.
The "Enter Number" prompt displays.
3. Enter a phone number using the numbers on the keypad and press **Save**. To backspace and erase a mistake, press **3** or press the **Delete Key** (Key 2).
The "Press 1st letter to enter name" prompt displays.
4. Enter a name to associate with the phone number you just entered, and press **Save**. Use the keypad to select the letters. Continue to press the number key to access the next letter for that key (for example, press **2** three times to access **C**). Press **4** to move to the next space, or wait a moment and the cursor automatically advances. To insert a space between letters, press **4**. To backspace and erase a mistake, press **3** or press the **Delete Key**.
The "Line" prompt displays. The default is **Line 1**.
5. If you want to save the new Directory entry to use Line 1, press **Save** to save the new entry to the Directory List.
If you want the new entry to use a different line, use the **2** key to select a different Line and press **Save**.
The new entry you added is saved to the Directory List.

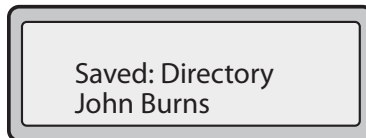



Edit an Entry in the Directory List

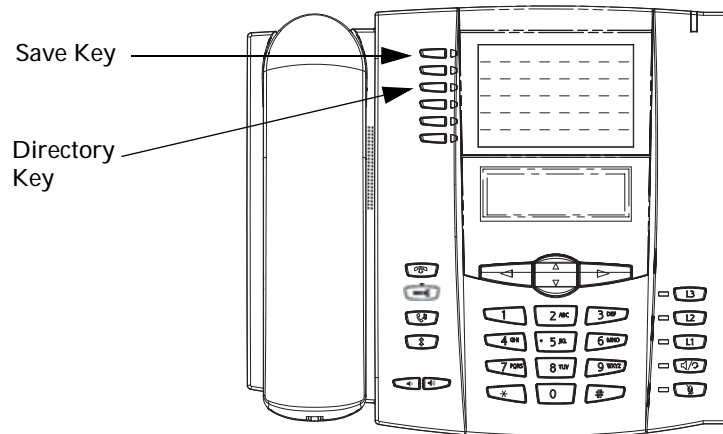

IP Phone UI

Use the following procedure to edit an entry in the Directory List. Use the following illustration as a reference.



1. Press the **Directory Key**.
2. Access the entry you want to edit by pressing the first letter of the name on the dial pad, or use 2 and 5 to scroll through the list to find the name.
3. To begin editing, press 3. Press 3 again to erase the numbers or letters to the left or use the dial pad to enter additional digits or characters once you have saved the number. If you don't want to change the number or name just press the **Directory Key** or the  Key at any time to exit.
4. Press the **Save Key** to finish.

Delete an Entry from the Directory List

You can delete a single entry from the Directory List, or you can delete all entries from the Directory List.



IP Phone UI

Use the following procedures to delete a single entry or all entries from the Directory List. Use the following illustration as a reference.

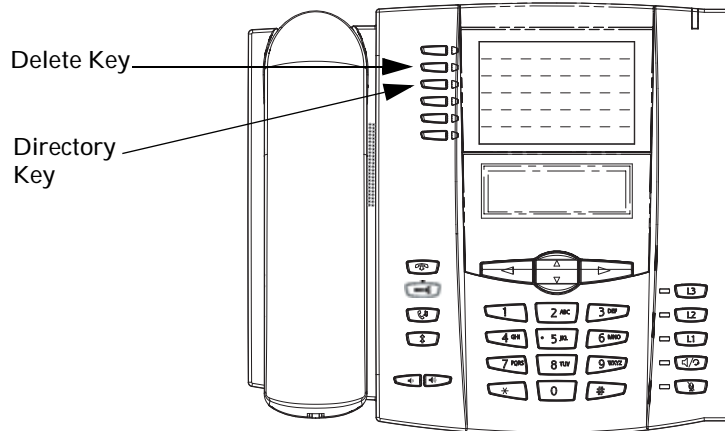

Delete a Single Entry

1. Press the **Directory** Key.
2. Press 2 and 5 to find the entry you want to delete.
3. Press the **Delete** Key.
The "*DELETE again to erase this item*" prompt displays.

DELETE again to
erase this item

4. Press the **Delete** Key again at the prompt to erase the entry.

Delete All Entries

1. Press the **Directory** Key.
2. Press the **Delete** Key.
The "*DELETE again to erase all items*" prompt displays.

DELETE again to
erase all items

3. Press the **Delete** Key again to erase all entries from the Directory List. The "*Directory empty*" prompt displays.

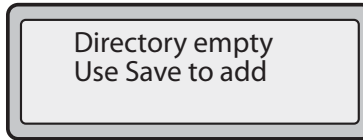

Save an Entry to the Directory List

You can save entries (names and numbers) from other sources to your Directory using any of the following methods:

- Saving from the Display
- Saving from the Caller List
- Saving from the Redial List

Saving from the Display

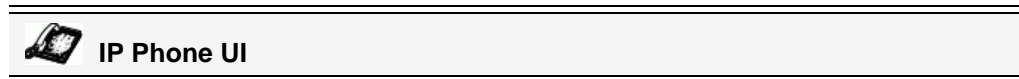

You can save the name and/or number displayed on your screen during a call to the Directory List, or to one of your programmable keys using the following procedure. Use the following illustration as a reference.

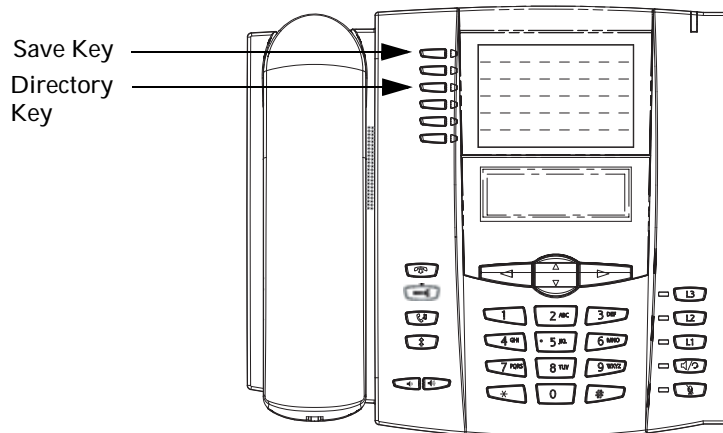

1. Press the **Save** Key during the call.

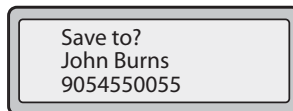

2. Press the **Directory** Key or an empty programmable key. If a name is displayed both the number and name are saved in the Directory List or the programmable key. If no name or "*Unknown Name*" displays, you can enter the name using the dial pad.
3. Press the **Save** Key to finish.

Saving from the Callers List



IP Phone UI

Use the following procedure to save names/numbers from the Callers List to the Directory. Use the following illustration as a reference.

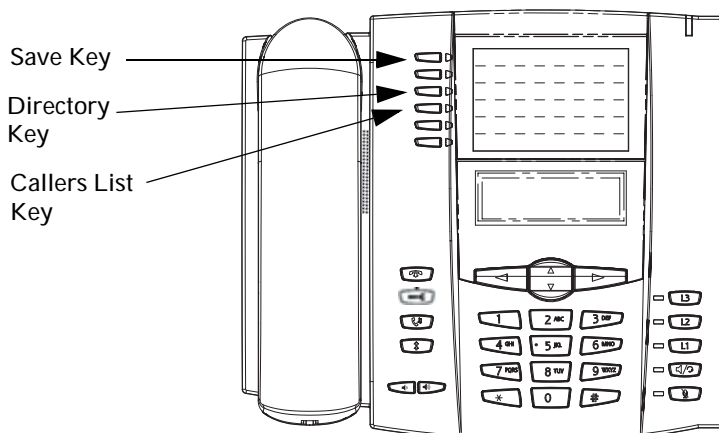

1. Press the **Callers List** Key (Key 4).
2. From the Callers List, scroll through the list to find the name and number that you want to save to your Directory.
3. Press the **Save** Key.
4. Press the **Directory** Key to save the number you selected to the Directory List. If the name is displayed with the number, both are saved to the Directory. If no name is displayed, you can enter the name using the dial pad.

Saving from the Redial List



IP Phone UI

Use the following procedure to save names/numbers from the Redial List to the Directory. Use the following illustration as a reference.

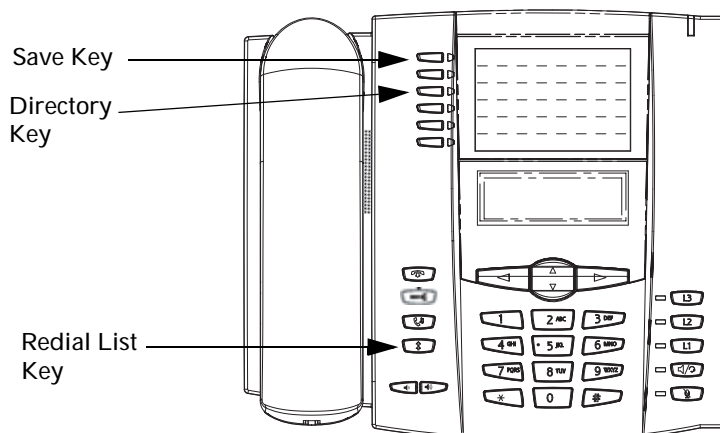

1. Press the **Redial List Key** ().
2. From the Redial List, scroll through the list to find the name and number that you want to save to your directory.
3. Press the **Save Key**.
4. Press the **Directory Key** to save the number you selected to the Directory List. If the name is displayed with the number, both are saved to the Directory. If no name is displayed, you can enter the name using the dial pad.

Downloading the Directory List to Your PC

You can download the Directory List to your PC via the Aastra Web UI. The phone stores the *directorylist.csv* file to your PC in comma-separated value (CSV) format.

You can use any spreadsheet application to open the file for viewing. The following is an example of a Directory List in a spreadsheet application. The file displays the name, phone number, and line number for each Directory entry.

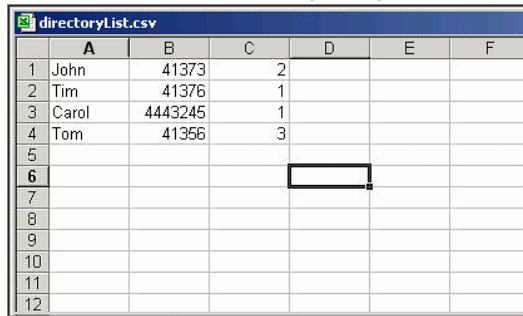

	A	B	C	D	E	F
1	John	41373	2			
2	Tim	41376	1			
3	Carol	4443245	1			
4	Tom	41356	3			
5						
6						
7						
8						
9						
10						
11						
12						



Note: Your System Administrator can populate your IP phone Directory List with server directory files. Contact your System Administrator for more details.

Download the Directory List

Use the following procedure to download the Directory List to your PC using the Aastra Web UI.



Aastra Web UI

1. Click on **Operation->Directory**.

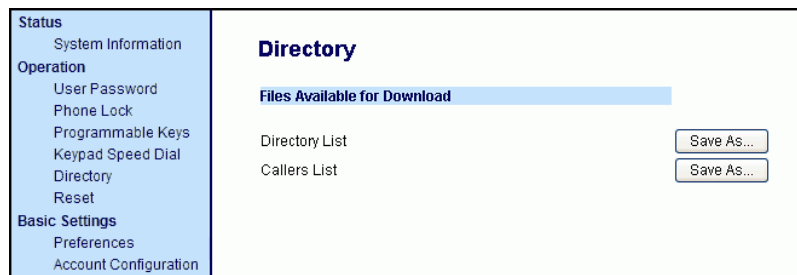

2. In the Directory List field, click on **Save As**.
A File Download message displays.
3. Click **OK**.
4. Enter the location on your computer where you want to download the Directory List and click **SAVE**.
The *callerslist.csv* file downloads to your computer.
5. Use a spreadsheet application to open and view the Directory List.

Callers List

The Callers list is a stored log of your incoming calls. The 6753i IP Phone stores information for up to 200 incoming calls in the Callers list.

By default, the Callers List Key is Key 4 on the top left of your phone.

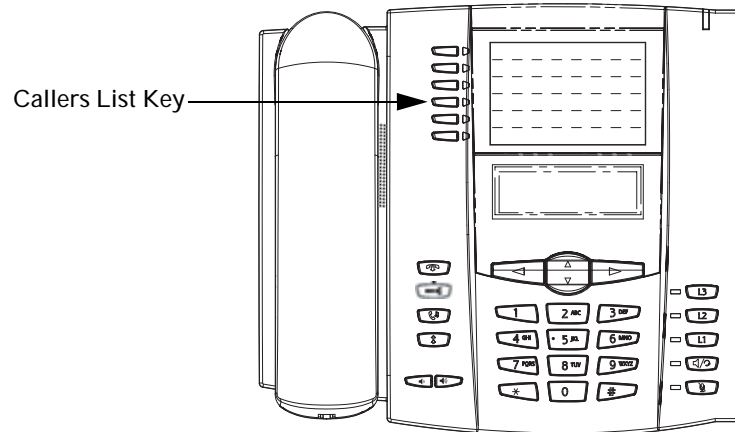





Note: Your System Administrator can create a custom Callers List XML application allowing you to access the Callers List via an XML Key instead of the Callers List Key. This allows you to configure the Callers List Key with other functions if required. Contact your System Administrator for more information.

Your phone logs the number and name (if available) of the caller, when they last called, and the number of times they tried to reach you. When the Callers list is full, the oldest call records are deleted to accommodate the information of new callers.

If the phone number of an incoming or outgoing call matches a number that you have programmed with a name in a programmable key or in the Directory List, the Callers List displays the name and number.

The display shows you how many callers have been added to the list since you last checked it.

Caller's List Screen Display

Display Item	Description
450-349-0438	Indicates you have returned the call from the Callers list.
N MAR 04 3:30pm 2x	"N" indicates a new call.
XX New Callers	When you're not on the telephone and not in the Callers list, the display shows you how many callers have been added to the list since you last checked it.
	Indicates an unanswered call in the Callers list.
	Indicates an answered call in the Callers list.
	Indicates a Call Waiting call in the Callers list.
	Indicates an incoming Call Waiting call.
John Burns 9054550055 Jun 8 2:41pm 2X	"2x" indicates this caller has called twice. The display shows the date and time of the last call from that caller.

You can view, scroll, and delete line items in the Callers List from the IP phone UI. You can also directly dial from a displayed line item in the Callers List.

Accessing the Callers List



IP Phone UI

Use the following procedure to access the Callers List. Use the following illustration as a reference.

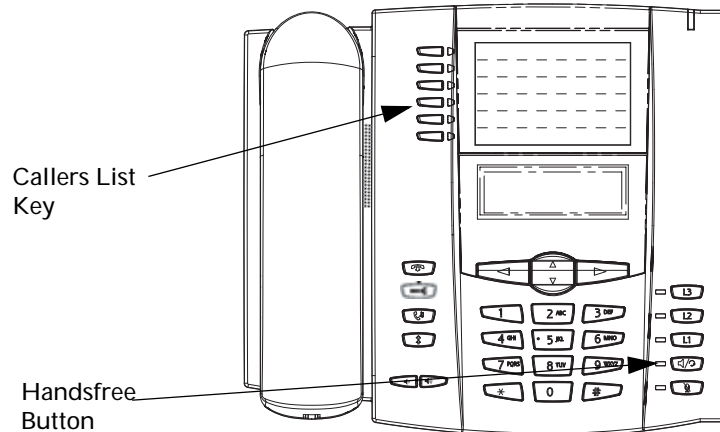

1. Press the **Callers List Key**. Press 2 and 5 to move through the Callers list. Press 2 to see the most recent call, or 5 to see the oldest call on your list.
2. To dial the displayed number just press  or lift the Handset or press any line keys.
3. Press the **Callers List Key** to cancel.

Editing Entries in the Callers List

Important: The Caller List does not save changes. Editing in the Callers List is generally used if you plan to call the number and need to add a prefix.

In the Callers List, if a dial pad key is pressed when a number and/or a name is displayed, the cursor automatically adds the digit at the left side of the number to enable the entry of the prefix.

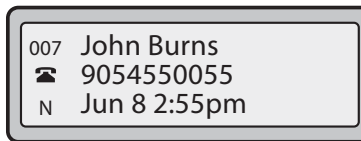



Use the following procedure to edit the Callers List. Use the following illustration as a reference.

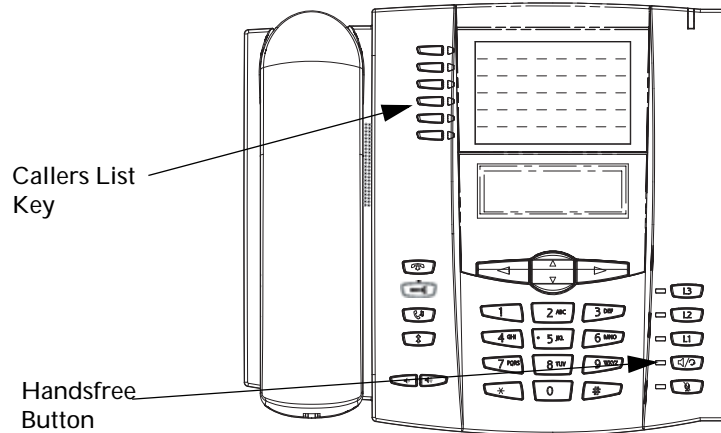

1. Press the **Callers List Key**.
2. Press 2 and 5 to find the entry you want to edit. Press 2 to view the most recent call, or 5 to see the oldest call on your list.
3. Press any key on the dial pad to begin editing.
4. To move the cursor one digit to the right, press 4. To erase one digit to the left of the cursor, press 3.
5. To dial the displayed number press , or just lift the handset, or press any line keys.

Deleting Entries From the Callers List

You can delete individual items from the Callers List, or you can delete all items in the Callers List.



IP Phone UI

Use the following procedure to delete an individual item from the Callers List. Use the following illustration as a reference.

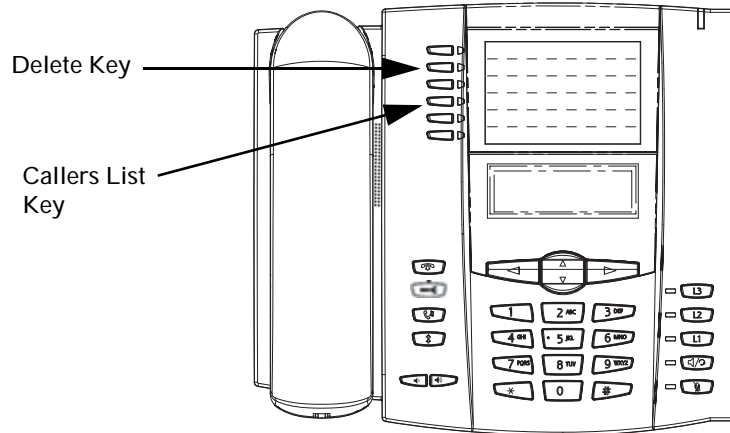

1. Press the **Callers List** Key.
2. Press 2 and 5 to find the item you want to delete.
3. Press the **Delete** Key.
4. Press the **Delete** Key again at the prompt to erase the item.



IP Phone UI

Use the following procedure to delete all items from the Callers List.

1. Press the **Callers List** Key.
2. Press the **Delete** Key.
3. Press the **Delete** Key again at the prompt to erase all items.

Downloading the Callers List to Your PC

You can download the Callers List to your PC for viewing using the Aastra Web UI. When you download the Callers List, the phone stores the *callerlist.csv* file to your computer in comma-separated value (CSV) format.

You can use any spreadsheet application to open the file for viewing. The following is an example of a Callers List in a spreadsheet application. This file displays the name, phone number, and the line that the call came in on.

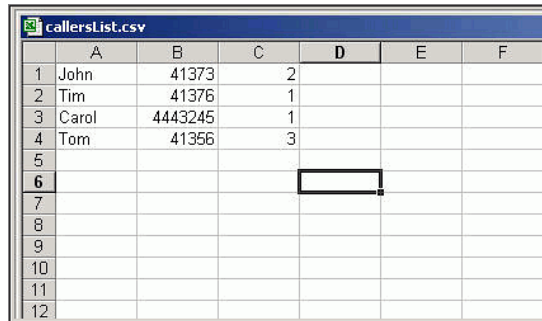

	A	B	C	D	E	F
1	John	41373	2			
2	Tim	41376	1			
3	Carol	4443245	1			
4	Tom	41356	3			
5						
6						
7						
8						
9						
10						
11						
12						

Download the Callers List

Use the following procedure to download the Callers List to your PC using the Aastra Web UI.



Aastra Web UI

1. Click on **Operation->Directory**.

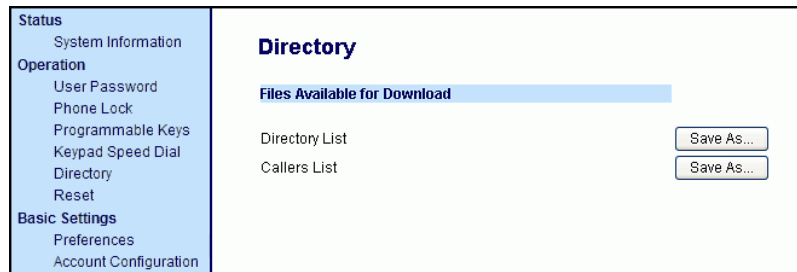

2. In the Callers List field, click on **Save As**.
A File Download message displays.
3. Click **OK**.
4. Enter the location on your computer where you want to download the Callers List and click **SAVE**.
The *callerslist.csv* file downloads to your computer.
5. Use a spreadsheet application to open and view the Callers List.

Account Configuration (DND and Call Forwarding)

The 6753i has a feature that allows you to configure “Do Not Disturb” (DND) and “call forwarding” (CFWD) for multiple accounts on the phone. You can set specific modes for the way you want the phone to handle DND and CFWD. The three modes you can set on the phone for these features are:

- Account
- Phone
- Custom

The following paragraphs describe account-based DND and CFWD:

- [DND Account-Based Configuration](#)
- [Call Forward Account-Based Configuration](#)

DND Account-Based Configuration

"Do Not Disturb" (DND) is a feature on the phone that prevents the phone from ringing and receiving incoming calls. When DND is enabled with "call forwarding" (CFWD), any incoming calls can be call forwarded to voicemail or another number. See "[Call Forward Account-Based Configuration](#)" on [page 148](#) for more information about call forwarding to other numbers.

On the 6753i, you can set DND on the phone-side for a specific account or for all accounts on the phone. You can set three modes for DND using the Aastra Web UI at the path, **Basic Settings->Preferences->General->DND Key Mode: Account, Phone (default), and Custom.** DND performs according to the mode you set.

You can then configure a DND key (for the phone or for an expansion module) using the Aastra Web UI at the path, **Operation->Programmable Keys**. You can enable and disable DND by toggling the key, or by setting DND for a specific account at the path, **Basic Settings->Account Configuration**. Once you enable DND, "DND" displays on the LCD for the applicable account.

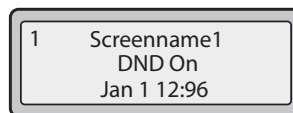

Note: If there is only one account configured on the phone, then the mode setting is ignored and the phone behaves as if the mode was set to “Phone”.

The following describes the key behavior for each DND mode.

- **Account** - DND key toggles the account in focus on the IP Phone UI, to ON or OFF if DND enabled for that account.
- **Phone** - (default) DND key toggles all accounts on the phone to ON or OFF.
- **Custom** - DND key displays custom screens on the IP Phone UI. User can select whether to enable/disable DND per account, enable DND on all accounts, or disable DND on all accounts.

The following table describes the key and Message Waiting Indicator (MWI) LEDs when you enable DND on the IP Phone.

Key LED Behavior for All Modes	MWI LED Behavior for All Modes
DND key LED RED if current account in focus has DND ON. DND key LED OFF when current account in focus has DND disabled.	MWI LED ON if current account in focus has DND ON. MWI LED OFF if current account in focus has DND OFF.



Note: If you make changes to the configuration for DND via the IP Phone UI, you must refresh the Aastra Web UI screen to see the changes.

Configuring a DND Key

To configure a DND key, see the section, [“Do Not Disturb \(DND\) Key”](#) on page 64.



Note: If there is no DND key configured or if it is removed, DND is disabled on the IP Phone.

Configuring DND Using the Aastra Web UI.



Aastra Web UI

Use the following procedure to configure DND using the Aastra Web UI.

1. Click on **Basic Settings->Preferences->General**

Preferences	
General	
Suppress DTMF Playback	<input checked="" type="checkbox"/> Enabled
Display DTMF Digits	<input type="checkbox"/> Enabled
Play Call Waiting Tone	<input checked="" type="checkbox"/> Enabled
Stuttered Dial Tone	<input checked="" type="checkbox"/> Enabled
XML Beep Support	<input checked="" type="checkbox"/> Enabled
Status Scroll Delay (seconds)	<input type="text" value="5"/>
Incoming Call Interrupts Dialing	<input type="checkbox"/> Enabled
Switch UI Focus To Ringing Line	<input checked="" type="checkbox"/> Enabled
Call Hold Reminder During Active Calls	<input type="checkbox"/> Enabled
Call Hold Reminder	<input type="checkbox"/> Enabled
Call Waiting Tone Period	<input type="text" value="0"/>
Preferred line	<input type="text" value="1"/>
Preferred line Timeout (seconds)	<input type="text" value="0"/>
Goodbye Key Cancels Incoming Call	<input checked="" type="checkbox"/> Enabled
Message Waiting Indicator Line	<input type="text" value="All"/>
DND Key Mode	<input type="text" value="Phone"/>
Call Forward Key Mode	<input type="text" value="Account"/>

2. In the “**DND Key Mode**” field, select a “do not disturb” (DND) mode to use on the phone. Valid values are: **Account**, **Phone** (default), **Custom**. Default is **Phone**.

- **account** Sets DND for a specific account. DND key toggles the account in focus on the phone to ON or OFF.
- **phone** (default) Sets DND ON for all accounts on the phone. DND key toggles all accounts on the phone to ON or OFF.
- **custom** Sets the phone to display custom screens after pressing the DND key, that list the account(s) on the phone. The user can select a specific account for DND, turn DND ON for all accounts, or turn DND OFF for all accounts.



Notes:

1. If there is only one account configured on the phone, then the mode setting is ignored and the phone behaves as if the mode was set to “Phone”.
2. Using the Aastra Web UI, if you change the DND Key Mode to “phone”, all accounts synchronize to the current setting of Account 1.

3. Click **Save Settings**. The changes takes affect immediately without a reboot.

4. Click on **Basic Settings->Account Configuration.**

Account	DND	Call Forward	State	Number	No. Rings
1. Screenname1	<input type="checkbox"/>	All <input type="checkbox"/> Busy <input type="checkbox"/> No Answer <input type="checkbox"/>	<input type="checkbox"/>	<input type="text"/>	1
2. Screenname2	<input type="checkbox"/>	All <input type="checkbox"/> Busy <input type="checkbox"/> No Answer <input type="checkbox"/>	<input type="checkbox"/>	<input type="text"/>	1
3. Screenname3	<input type="checkbox"/>	All <input type="checkbox"/> Busy <input type="checkbox"/> No Answer <input type="checkbox"/>	<input type="checkbox"/>	<input type="text"/>	1

5. For each account, enable DND by placing a check mark in the box. Disable DND by unchecking the box.



Notes:

1. If you selected “**Account**” or “**Custom**” mode in step 2, you can enable/disable each account or all accounts as applicable. If you selected “**Phone**” mode, the first account allows you to change the DND status for all accounts.

2. Number and name of accounts that display to this screen are dependant on the number and name of accounts configured on the phone. In the screen in step 4, Screenname1 is configured on Line 1, Screenname2 is configured on Line 2, and Screenname3 is configured on Line 3. Only your Administrator can create accounts for your phone. Contact your Administrator for more information.

6. Click **Save Settings**. The changes takes affect immediately without a reboot.

Using DND Modes via the IP Phone UI

After you add a DND key to your phone, you can toggle the DND state using this key on the phone. Use the following procedure to enable/disable DND on the IP Phone.



IP Phone UI

The following procedures assume you have already configured a DND key AND assumes there are three accounts configured on the phone.



Notes:

1. If there is no DND key configured or if it is removed, DND is disabled on the IP Phone.

2. If there is only one account configured on the phone, then the mode setting is ignored and the phone behaves as if the mode was set to “Phone”.

3. Using the Aastra Web UI, if you change the DND key mode to “phone”, all accounts synchronize to the current setting of Account 1.

DND in Account Mode

1. With the account in focus on the IP Phone UI, press the **DND** key to toggle DND ON or OFF for the account.
2. Use the RIGHT and LEFT arrow keys to scroll through each account.

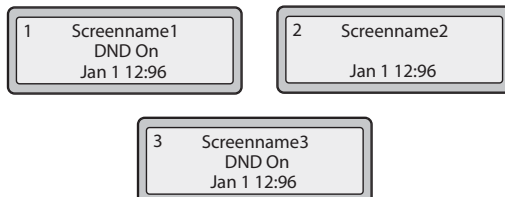

In the above example, Screenname1, Screenname2, and Screenname3, are three accounts configured on the phone. Only Screenname1 and 3 have DND ON. Screenname 2 has DND OFF.

DND in Phone Mode (Default)

1. Press the **DND** key to toggle DND ON or OFF for all accounts on the phone. Toggling to ON enables DND on all accounts on the phone. Toggling to OFF disables DND on all accounts on the phone.
2. Use the RIGHT and LEFT arrow keys to scroll through each account.

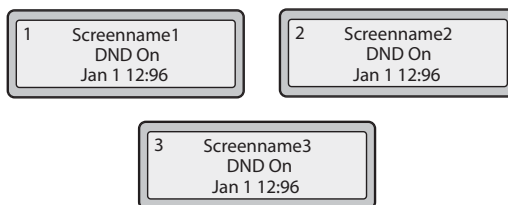

In the above example, toggling Screenname1 to DND ON, enabled DND for Screenname2 and 3 also.

DND in Custom Mode

1. Press the **DND** key on the phone. The screen displays a list of the accounts on the phone and allows you to enable/disable a specific account or all accounts.
2. Use the UP and DOWN arrow keys to scroll through the accounts.

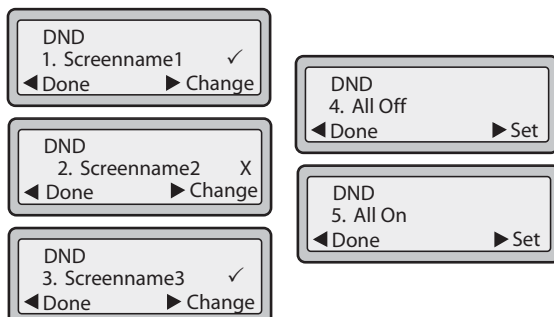

In the above example, Screenname1 and 3 have DND ON as indicated by a check mark (✓). Screenname2 has DND off as indicated by an X. Items 4 and 5 allow you to disable or enable DND on all accounts, respectively.

3. Use the **CHANGE** key to enable or disable DND for a specific account.
4. Use the **SET** key to enable/disable DND for all accounts.
5. After making the change, press **DONE** and then Confirm (#) to save the change. Pressing

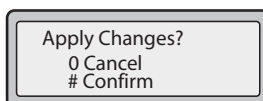

Cancel (0) cancels the attempted change. The following screen displays after pressing a **DONE** key:

Call Forward Account-Based Configuration

Call Forward (CFWD) on the IP phone allows incoming calls to be forwarded to another destination.

On the 6753i, you can set Call Forward (CFWD) on the phone-side for a specific account or for all accounts on the phone. You can set three modes for CFWD using the Aastra Web UI at the path, *Basic Settings->Preferences->General->Call Forward Key Mode*:

- **Account** (default)
- **Phone**
- **Custom**

CFWD performs according to the mode you set.

You can configure CFWD using the Aastra Web UI at the path, **Basic Settings->Account Configuration**, **OR** you can configure CFWD using the IP Phone UI at the path, **Options->Call Forward**.

Using the Aastra Web UI at the path, **Operation->Programmable Keys**, you can also configure a CFWD key (on the phone or on an expansion module) to use as a shortcut for accessing the CFWD menu on the phone.

The following describes the behavior for each CFWD mode.

- **Account** - (default) The account mode allows you to configure CFWD on a per account basis. Pressing a configured CFWD key applies to the account in focus.
- **Phone** - The Phone mode allows you to set the same CFWD configuration for all accounts (All, Busy, and/or No Answer). When you configure the initial account, the phone applies the configuration to all other accounts. (In the Aastra Web UI, only the account you configured is enabled. All other accounts are grayed out but set to the same configuration.) Using the Aastra Web UI, if you make changes to that initial account, the changes apply to all accounts on the phone.
- **Custom** - The Custom mode allows you to configure CFWD for a specific account or all accounts. You can configure a specific mode (All, Busy, and/or No Answer) for each account independently or all accounts. On the 6753i, you can set all accounts to ALL On or ALL Off.



Note: If there is only one account configured on the phone, then the mode setting is ignored and the phone behaves as if the mode was set to “Phone”.

You can enable different CFWD rules/modes independently (for example, you can set different phone numbers for Busy, All, and NoAns modes and then turn them on/off individually).

The following table describes the key and Message Waiting Indicator (MWI) LEDs when you enable CFWD on the IP Phone.

Key LED Behavior for All Modes	MWI LED Behavior for All Modes
CFWD key LED RED if CFWD All, CFWD Busy, or CFWD No Answer is enabled for the account in focus. CFWD key LED OFF if any CFWD mode is disabled.	MWI LED ON if current account in focus has CFWD ALL enabled. MWI LED OFF if CFWD All is disabled.



Note: If you make changes to the configuration for CFWD via the IP Phone UI, you must refresh the Aastra Web UI screen to see the changes.

Configuring CFWD Using the Aastra Web UI



Aastra Web UI

Use the following procedure to configure CFWD using the Aastra Web UI.

1. Click on **Basic Settings->Preferences->General**

Preferences	
General	
Suppress DTMF Playback	<input checked="" type="checkbox"/> Enabled
Display DTMF Digits	<input type="checkbox"/> Enabled
Play Call Waiting Tone	<input checked="" type="checkbox"/> Enabled
Stuttered Dial Tone	<input checked="" type="checkbox"/> Enabled
XML Beep Support	<input checked="" type="checkbox"/> Enabled
Status Scroll Delay (seconds)	<input type="text" value="5"/>
Incoming Call Interrupts Dialing	<input type="checkbox"/> Enabled
Switch UI Focus To Ringing Line	<input checked="" type="checkbox"/> Enabled
Call Hold Reminder During Active Calls	<input type="checkbox"/> Enabled
Call Hold Reminder	<input type="checkbox"/> Enabled
Call Waiting Tone Period	<input type="text" value="0"/>
Preferred line	<input type="text" value="1"/>
Preferred line Timeout (seconds)	<input type="text" value="0"/>
Goodbye Key Cancels Incoming Call	<input checked="" type="checkbox"/> Enabled
Message Waiting Indicator Line	<input type="text" value="All"/>
DND Key Mode	<input type="text" value="Phone"/>
Call Forward Key Mode	<input type="text" value="Account"/>

2. In the “**Call Forward Key Mode**” field, select a call forward mode to use on the phone. Valid values are: Account, Phone, Custom. Default is **Account**.

- **Account** - (default) The account mode allows you to configure CFWD on a per account basis. Pressing a configured CFWD key applies to the account in focus.
- **Phone** - The Phone mode allows you to set the same CFWD configuration for all accounts (All, Busy, and/or No Answer). When you configure the initial account, the phone applies the configuration to all other accounts. (In the Aastra Web UI, only the account you configured is enabled. All other accounts are grayed out but set to the same configuration.) Using the Aastra Web UI, if you make changes to that initial account, the changes apply to all accounts on the phone.
- **Custom** - The Custom mode allows you to configure CFWD for a specific account or all accounts. You can configure a specific state (All, Busy, and/or No Answer) for each account independently or all accounts. On the 6753i, you can set all accounts to ALL On or ALL Off.



Note: If there is only one account configured on the phone, then the mode setting is ignored and the phone behaves as if the mode was set to “Phone”.

3. Click **Save Settings**.

The changes takes affect immediately without a reboot.

4. Click on **Basic Settings->Account Configuration.**

Account	DND	Call Forward	State	Number	No. Rings
1. Screenname1	<input type="checkbox"/>	All <input type="checkbox"/> Busy <input type="checkbox"/> No Answer <input type="checkbox"/>	<input type="checkbox"/>	<input type="text"/>	1 ▾
2. Screenname2	<input type="checkbox"/>	All <input type="checkbox"/> Busy <input type="checkbox"/> No Answer <input type="checkbox"/>	<input type="checkbox"/>	<input type="text"/>	1 ▾
3. Screenname3	<input type="checkbox"/>	All <input type="checkbox"/> Busy <input type="checkbox"/> No Answer <input type="checkbox"/>	<input type="checkbox"/>	<input type="text"/>	1 ▾

Save Settings

The illustration above shows 3 accounts configured on the phone. Accounts must be set up by your System Administrator.

5. For each account, enable the CFWD state by placing a check mark in one or more of the following “**State**” fields:

- **All**
- **Busy**
- **No Answer**

The “**All**” option forwards all incoming calls for this account to the specified phone number regardless of the state of the phone. The phone can be in the Busy or No Answer states, or can be in the idle state. The phone still forwards all calls to the specified number.

The “**Busy**” option call forwards incoming calls only if the account is in the busy state. The calls are forwarded to the specified phone number.

The “**No Answer**” option call forwards incoming calls only if the account rings but is not answered in the defined number of rings. The call gets forwarded to the specified number.



Note: You can use the “**Busy**” and “**No Answer**” states together using different forwarding phone numbers. If these states are enabled for an account (the “**All**” state is disabled), and the phone is in the busy state when a call comes in, the phone can forward the call to the specified phone number (for example, voicemail). If there is no answer on the phone after the specified number of rings, the phone can forward the call to a different specified number, such as a cell phone number.

6. For each account, in the “**Number**” field, enter the phone number for which you want the incoming calls to forward to if the phone is in the specified state.

If using the “**Account**” mode or “**Custom**” mode, you can enter different phone numbers for each account.

**Notes:**

1. If you selected “**Account**” mode in step 2, you can enable/disable each account or all accounts as applicable. You can enter different phone number for each enabled state.

If you selected “**Custom**” mode, you can enable/disable each account or all accounts as applicable. You can enter different phone numbers for each enabled state.

If you selected “**Phone**” mode, all accounts are set to the same CFWD configuration (All, Busy, and/or No Answer) as Account 1 on the phone. (In the Aastra Web UI, only Account 1 is enabled. All other accounts are grayed out but use the same configuration as Account 1.)

Using the Aastra Web UI, if you make changes to Account 1, the changes apply to all accounts on the phone. Using the IP Phone UI, if you make changes to any other account other than Account 1, the changes also apply to all accounts on the phone. When enabling a CFWD state, you must specify a phone number for the phone to CFWD to. The number you specify applies to all accounts of the same mode.

2. Number and name of accounts that display to this screen are dependant on the number and name of accounts configured on the phone. In the screen in step 4, Screenname1 is configured on Line 1, Screenname2 is configured on Line 2, and Screenname3 is configured on Line 3. The name for the account is specified by your System Administrator. Contact your System Administrator for more information.

-
7. For the “**No Answer**” state, in the “**No. Rings**” field, enter the number of times that the account rings before forwarding the call to the specified number. Valid values are 1 through 20. Default is 1.

When using the “**Account**” mode or “**Custom**” mode, you can enter a different number of rings for each account. If you use the Aastra Web UI to change the Call Forward Key Mode to “**Phone**”, all accounts synchronize to Account 1.

8. (Optional) You can configure a Call Forward key on your phone to access the Call Forward menus if desired. You can also access the Call Forward menu from the IP Phone UI at the path, *Options->Call Forward*. To create a Call Forward key, see “[Call Forward Key](#)” on [page 87](#).
9. Click **Save Settings**.
The changes takes affect immediately without a reboot.

Using CFWD via the IP Phone UI

Once CFWD is enabled on your phone, you can access and change the configuration using the IP Phone UI or the Aastra Web UI. You can access the CFWD menus by pressing a pre-configured Call Forward key, or by selecting *Options->Call Forward* from the IP Phone UI.

The following procedure assumes you have already configured a CFWD key AND assumes there are three accounts configured on the phone.



Notes:

1. If there is no CFWD key configured on the phone or it is removed, you can still enable CFWD via the IP Phone UI at the path Options->Call Forward.
2. If there is only one account configured on the phone, then the mode setting is ignored and the phone behaves as if the mode was set to "Phone".
3. Using the Aastra Web UI, if you change the CFWD key mode to "Phone", all accounts synchronize to the current setting of Account 1.

CFWD in Account Mode

1. Use the **RIGHT** and **LEFT** arrow keys to scroll through each account.

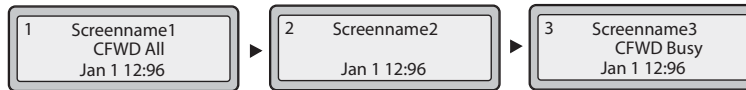

In the above example, Screenname1, Screenname2, and Screenname3, are three accounts configured on the phone. Screenname1 has "CFWD All" enabled, Screenname 2 has CFWD disabled as indicated by no message displayed, and Screenname3 has "CFWD Busy" enabled.

2. Press the **Call Forward** key. The Call Forward Mode screen displays. Use the **UP** and **DOWN** arrow keys to scroll through each state type.

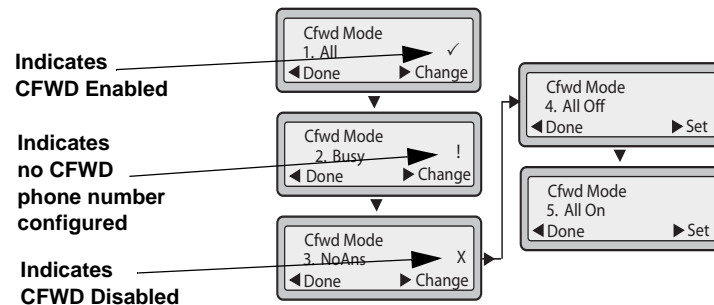

In the above example, CFWD All is enabled as indicated by a check mark (✓), CFWD Busy is enabled but no call forward phone number configured as indicated by a !, and CFWD NoAns is disabled, as indicated by an X.

3. Select a state for the account(s) in focus using the **UP** and **DOWN** arrow keys. You can enable/disable any or all of the following states for an account:
 - **All** - Enables CFWD All for an account and forwards all incoming calls for that account, to the specified number.
 - **Busy** - Enables CFWD Busy for an account and forwards incoming calls to a specified number if DND has been enabled for that account OR if the account is currently engaged in another call.
 - **No Answer** - Enables CFWD NoAns for an account and forwards incoming calls to a specified number if the call has not been answered for the specified number of rings.



Note: If **CFWD All** AND **CFWD Busy** AND **CFWD NoAns** are all enabled (and/or if the account has DND enabled), the CFWD All settings take precedence over CFWD Busy and CFWD NoAns.

You can also use the following keys if required:

- **All Off** - Disables all CFWD states for the current account in focus.
 - **All On** - Enables all CFWD states for the current account in focus.
4. Press the **CHANGE** key for the state you selected in step 3. Scroll to the CFWD State screen. This displays the current state of the mode you selected. In the following example, the CFWD All state is ON.

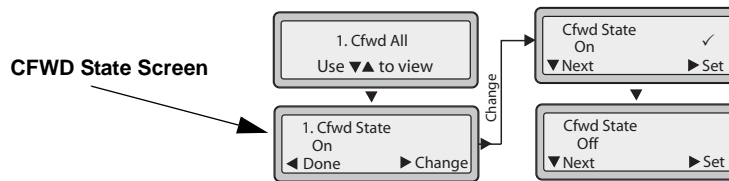

5. Press the **CHANGE** key in the CFWD State screen. Press **NEXT** to toggle the state of the CFWD mode ON or OFF. In the example in Step 4, you press **NEXT** to change the option to OFF.
6. Press **SET** to save the change.
7. In the CFWD State screen, press the **DOWN** arrow key to scroll to the CFWD Number screen and press **CHANGE**.

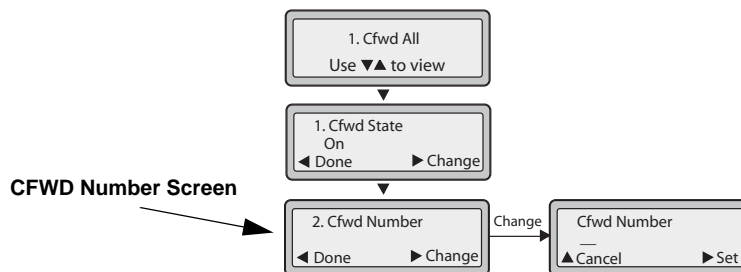

8. Enter a phone number to apply to the current state in focus. When the phone is in the state you specified, and a call comes into the phone, it forwards the call to the number you specify.
9. Press **SET** to save the change.
10. For the **CFWD No Answer** state, In the CFWD Number screen, press the **DOWN** arrow key to scroll to the CFWD No. Rings screen and press **CHANGE**.

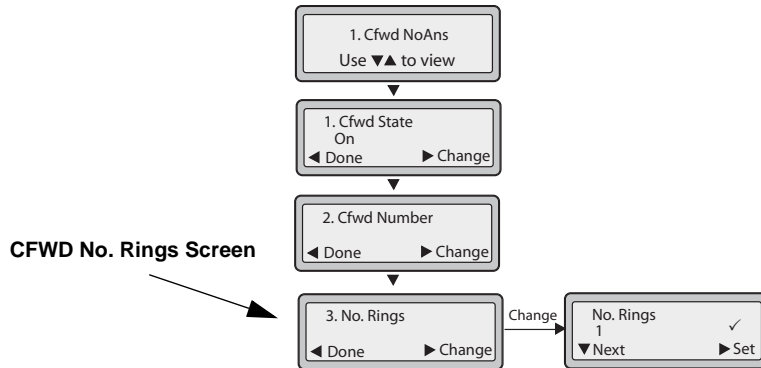

11. Press **NEXT** to select the number of rings to apply to the phone for call forwarding incoming calls. Valid values are 1 to 20. Default is 1.

When the phone receives an incoming call, and call forward is configured on the phone, the phone rings the number of times you specify in the No. Rings screen, and then forwards the call if there is no answer.

12. Press **SET** to save the change.
13. Press **DONE** to save CFWD All Number, CFWD All State, CFWD Busy Number, CFWD Busy State, CFWD No Answer Number, CFWD No Answer State, CFWD No Answer Rings.

Each time you press **DONE**, the following “Apply Changes” screen displays.

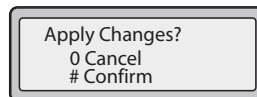

14. Press **#** to confirm the change(s) each time the “Apply Changes” screen displays. All changes are saved to the phone.

CFWD in Phone Mode

1. Use the **RIGHT** and **LEFT** arrow keys to scroll through each account.

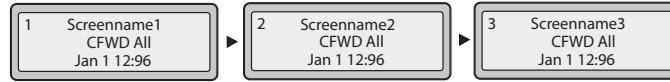

In the above example, Screenname1, Screenname2, and Screenname3, are three accounts configured on the phone. All three accounts have CFWD enabled as indicated by the “CFWD All” message.



Note: In “Phone” mode, when you change the call forward configuration for an account, the change applies to all accounts.

2. Press the **Call Forward** key. The Call Forward menu displays. Use the **UP** and **DOWN** arrow keys to scroll through each state type.

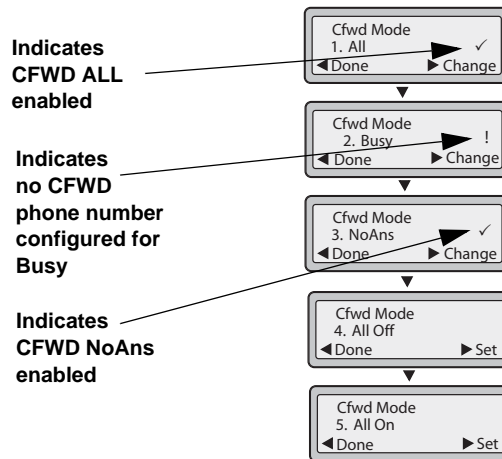

In the above example, the account has CFWD All and CFWD NoAns enabled as indicated by a check mark (✓). The CFWD Busy setting is enabled but no call forward phone number is configured as indicated by a !.

3. Select a state using the **UP** and **DOWN** arrow keys.

You can enable/disable a specific account on the phone with any or all of the following states. However, the configuration you set will apply to all accounts on the phone.

- **All** - Enables CFWD All on the phone and forwards all incoming calls to the specified number.
- **Busy** - Enables CFWD Busy on the phone and forwards incoming calls to a specified number if DND has been enabled OR if the phone is currently engaged in another call.
- **No Answer** - Enables CFWD NoAns on the phone and forwards incoming calls to a specified number if the call has not been answered for the specified number of rings.



Note: If **CFWD All** AND **CFWD Busy** AND **CFWD NoAns** are all enabled (and/or if the account has DND enabled), the CFWD All settings take precedence over CFWD Busy and CFWD NoAns.

You can also use the following keys if required:

- **All Off** - Disables all CFWD states for the phone.
- **All On** - Enables all CFWD states for the phone.



Note: In “Phone” mode, the initial configuration you set for an account applies to all the accounts on the phone.

4. Press the **CHANGE** key for the mode you selected in Step 2. Scroll to the CFWD State screen. This screen displays the current state of the mode you selected. In the following example, the CFWD All state is ON.

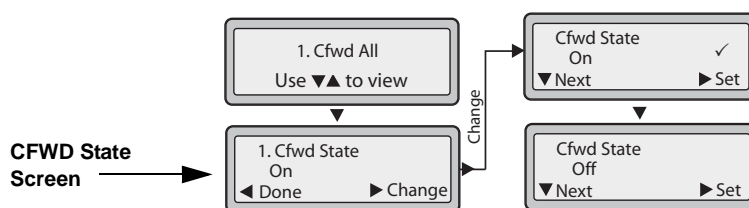

5. Press the **CHANGE** key in the CFWD State screen. Press **NEXT** to toggle the state of the CFWD state ON or OFF. In the example in Step 4, you press **NEXT** to change the option to **OFF**.
6. Press the **SET** key to save the change.
7. In the CFWD State screen, press the **DOWN** arrow key to scroll to the CFWD Number screen and press **CHANGE**

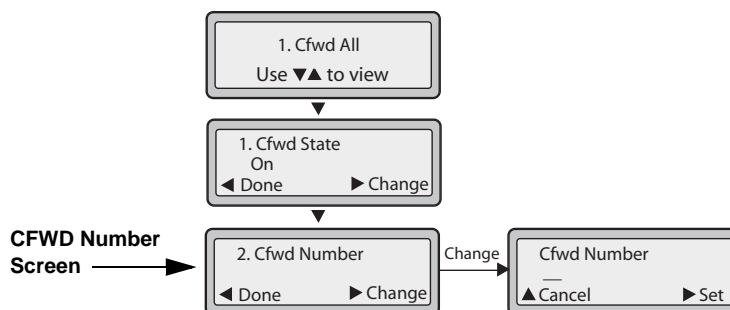

8. Enter a phone number to apply to the current state in focus. When the phone is in the state you specified, and a call comes into the phone, it forwards the call to the number you specify.
9. Press **SET** to save the change.

10. For the **CFWD No Answer** state, in the CFWD Number screen, press the **DOWN** arrow key to scroll to the CFWD No. Rings screen and press **CHANGE**.

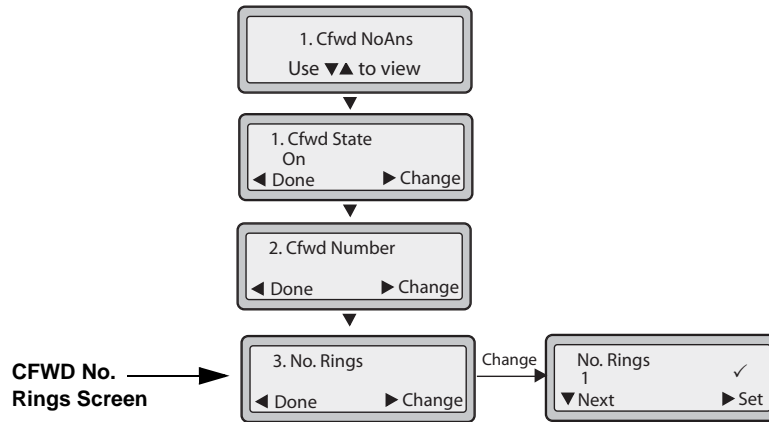

11. Press the **NEXT** key to select the number of rings to apply to the phone for call forwarding incoming calls. Valid values are 1 to 20. Default is 1.

When the phone receives an incoming call, and call forward is configured on the phone, the phone rings the number of times you specify in the No. Rings screen, and then forwards the call.

12. Press **SET** to save the change.
13. Press **DONE** to save CFWD All Number, CFWD All State, CFWD Busy Number, CFWD Busy State, CFWD No Answer Number, CFWD No Answer State, CFWD No Answer Rings.

Each time you press **DONE**, the following “Apply Changes” screen displays.

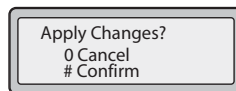

14. Press **#** to confirm the change(s) each time the “Apply Changes” screen displays.

All the same changes are saved to all accounts on the phone.

CFWD in Custom Mode

1. Use the **RIGHT** and **LEFT** arrow keys to scroll through each account.

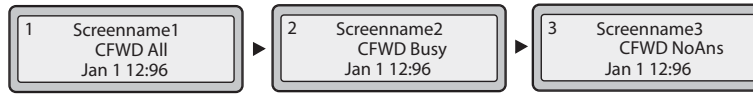

In the above example, Screenname1, Screenname2, and Screenname3, are three accounts configured on the phone. All three accounts have CFWD enabled as indicated by the “**CFWD All**”, “**CFWD Busy**”, and “**CFWD NoAns**” messages.

Press the **Call Forward** key. The CFWD Account screens display. Use the **UP** and **DOWN** arrow keys to scroll through each account.

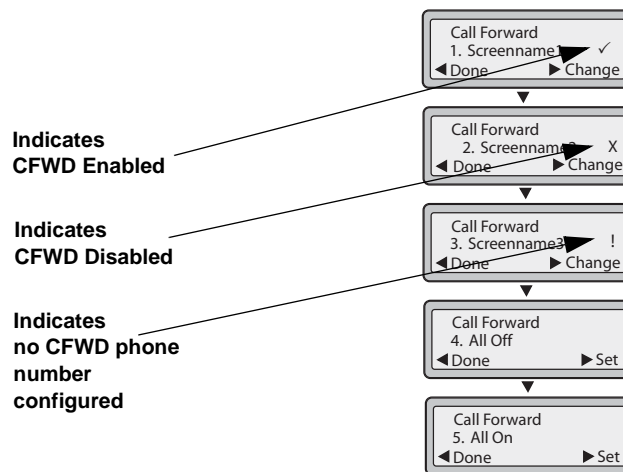

In the above example, Screenname1 has one or more CFWD states enabled as indicated by a check mark (✓). Screenname2 has one or more CFWD states disabled as indicated by an **X**. Screenname3 has one or more CFWD states configured but a specific state has no call forward phone number configured as indicated by a **!**. Items 4 and 5 allow you to disable or enable CFWD on all accounts, respectively.

- Select an account to configure. Press the **CHANGE** key. The CFWD Mode screen displays. Use the **UP** and **DOWN** arrow keys to scroll through each state screen.

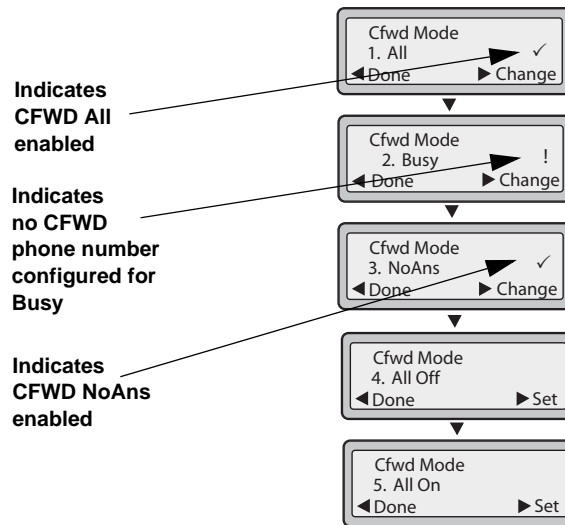

In the above example, the account has **CFWD All** and **CFWD NoAns** enabled as indicated by a check mark (✓). The **CFWD Busy** setting is enabled for the account but has no call forward phone number configured as indicated by a !.

- Select a state for the account(s) in focus using the **UP** and **DOWN** arrow keys.

You can enable/disable any or all of the following states for a specific account or for all accounts (with individual configurations):

- All** - Enables **CFWD All** for an account and forwards all incoming calls for that account, to the specified number. The phone number can be different between accounts.
- Busy** - Enables **CFWD Busy** for an account and forwards incoming calls to a specified number if DND has been enabled for that account OR if that account is currently engaged in another call. The phone number can be different between accounts.
- No Answer** - Enables **CFWD NoAns** for an account and forwards incoming calls to a specified number if the call has not been answered for a specified number of rings. The phone number can be different between accounts.



Note: If **CFWD All** AND **CFWD Busy** AND **CFWD NoAns** are all enabled (and/or if the account has DND enabled), the **CFWD All** settings take precedence over **CFWD Busy** and **CFWD NoAns**.

You can also use the following keys if required:

- All Off** - Disables all CFWD states for the current account in focus or all accounts.
- All On** - Enables all CFWD states for the current account in focus or all accounts.

- Press the **CHANGE** key for the mode you selected in step 2. Scroll to the CFWD State screen. This displays the current state of the mode you selected. In the following example, the CFWD All state is ON.

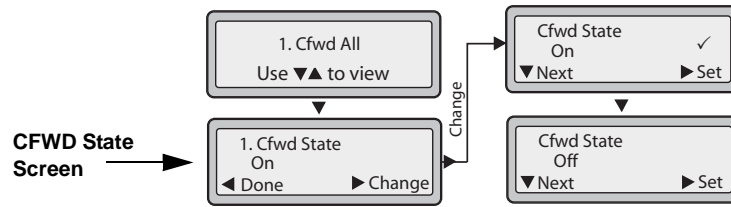

- Press the **CHANGE** key in the CFWD State screen. Press **NEXT** to toggle the state of the CFWD state ON or OFF. In the example in Step 4, you press **NEXT** to change the option to **OFF**.
- Press the **SET** key to save the change.
- In the CFWD State screen, press the **DOWN** arrow key to scroll to the CFWD Number screen and press **CHANGE**.

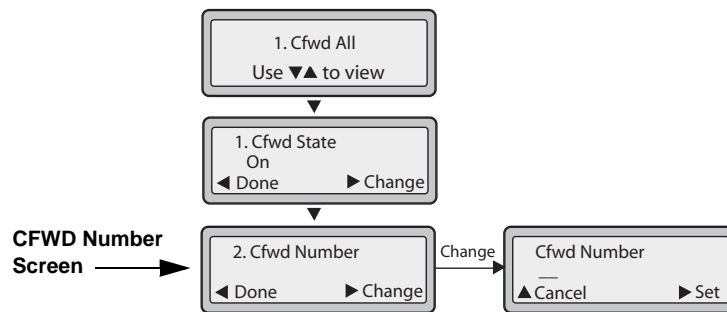

- Enter a phone number to apply to the current state in focus. When the phone is in the state you specified, and a call comes into the phone, it forwards the call to the number you specify.
- Press **SET** to save the change.

10. For the **CFWD No Answer** state, in the CFWD Number screen, press the **DOWN** arrow key to scroll to the CFWD No. Rings screen and press **CHANGE**.

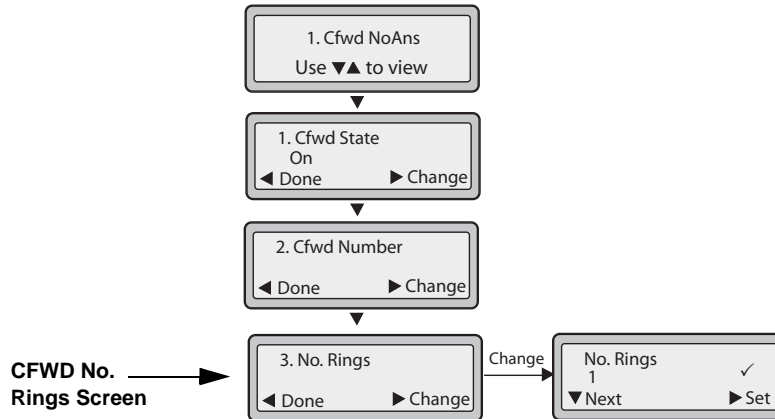

11. Press the **NEXT** key to select the number of rings to apply to the phone for call forwarding incoming calls. Valid values are 1 to 20. Default is 1.

When the phone receives an incoming call, and call forward is configured on the phone, the phone rings the number of times you specify in the No. Rings screen, and then forwards the call.

12. Press **SET** to save the change.
13. Press **DONE** to save CFWD All Number, CFWD All State, CFWD Busy Number, CFWD Busy State, CFWD No Answer Number, CFWD No Answer State, CFWD No Answer Rings.

Each time you press **DONE**, the following “Apply Changes” screen displays.

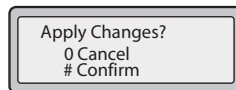

14. Press **#** to confirm the change(s) each time the “Apply Changes” screen displays.

All changes are saved to the phone for all accounts.

Voicemail

The Voicemail feature on the 6753i IP phone allows you to use a line, configured with a phone number for dialing out, to connect to a voicemail server.

For each assigned Voicemail number, there can be a minimum of 0 or a maximum of 1 Voicemail access phone number.

The Voicemail list displays a list of phone numbers assigned to the 6753i that have registered voicemail accounts associated with them.



Note: The Voicemail list does not display the voicemail access number.

The phone displays up to 99 voicemail messages for an account even if the number of voicemails exceeds the limit.

Registered account numbers/URIs that exceed the length of the screen, either with or without the voicemail icon and the message count, are truncated with an ellipse character at the end of the number/URI string.

The end of the Voicemail list displays the number of new voicemail messages (if any exist).

Contact your System Administrator for lines configured for Voicemail.

Using Voicemail



IP Phone UI

1. Press the key on the phone that your System Administrator set up to access voicemail. After pressing the key, the phone dials to access the voicemail server.
2. Use the 2 and 5 keys to scroll through the line items in the Voicemail list.
3. When you have selected a line item, press the  handsfree key, 4 **Scroll Right** key, or press a line key to make an outgoing call using the voicemail access phone number associated with the line for which the voicemail account is registered.

From a selected item in the Voicemail list, you can also lift the handset (go offhook) to make an outgoing call using the voicemail access phone number.

Additional Features

This section describes additional features you can use on the 6753i phone.

Star Codes

All of the main call handling and extension management features using star codes can be set on your phone by your Administrator. Contact your System Administrator for more information.

If these have not been set up, you can dial any star code commands on the 55i phone the same way you would on a regular telephone.

Suppress DTMF Playback

A feature on the IP phones allows you to enable or disable the suppression of DTMF playback when a number is dialed from the keys on your phone.

When suppression of DTMF playback is disabled, and you press a key, the IP phone dials the stored number and displays each digit as dialed, in the LCD window.

When the suppression of DTMF playback is enabled, the IP phone dials the stored number and displays the entire number immediately in the LCD window, allowing the call to be dialed faster.

DTMF playback suppression is enabled by default. Disabling suppression of DTMF playback can be configured using the Aastra Web UI.

Configuring Suppression of DTMF Playback



Aastra Web UI

Use the following procedure to configure suppression of DTMF playback.



Note: "Suppress DTMF Playback" is enabled by default.

1. Click on **Basic Settings->Preferences->General**.

Preferences	
General	
Suppress DTMF Playback	<input checked="" type="checkbox"/> Enabled
Display DTMF Digits	<input type="checkbox"/> Enabled
Play Call Waiting Tone	<input checked="" type="checkbox"/> Enabled
Stuttered Dial Tone	<input checked="" type="checkbox"/> Enabled
XML Beep Support	<input checked="" type="checkbox"/> Enabled
Status Scroll Delay (seconds)	<input type="text" value="5"/>
Incoming Call Interrupts Dialing	<input type="checkbox"/> Enabled
Switch UI Focus To Ringing Line	<input checked="" type="checkbox"/> Enabled
Call Hold Reminder During Active Calls	<input type="checkbox"/> Enabled
Call Hold Reminder	<input type="checkbox"/> Enabled
Call Waiting Tone Period	<input type="text" value="0"/>
Preferred line	<input type="text" value="1"/>
Preferred line Timeout (seconds)	<input type="text" value="0"/>
Goodbye Key Cancels Incoming Call	<input checked="" type="checkbox"/> Enabled
Message Waiting Indicator Line	<input type="text" value="All"/>
DND Key Mode	<input type="text" value="Phone"/>
Call Forward Key Mode	<input type="text" value="Account"/>

2. Go to the "**General**" section.
3. The parameter "**Suppress DTMF Playback**" is enabled by default. (Disable this field by unchecking the box). Default is enabled.
4. Click **Save Settings**.

Display DTMF Digits

A feature on the IP phones allows users to enable or disable DTMF (dual-tone multi-frequency) digits to display to the IP phone when using the keypad to dial, or when dialing from a programmed key.

DTMF is the signal sent from the phone to the network that you generate when you press the phone's touch keys. This is also known as "touchtone" dialing. Each key you press on your phone generates two tones of specific frequencies. One tone is generated from a high-frequency group of tones and the other from a low frequency group.

If you enable the Display DTMF Digits parameter, the digits you are dialing from the keypad or from a programmable key display to the IP phone's LCD display. This parameter is disabled by default (no digits display when dialing).

You can enable the "Display DTMF Digits" parameter using the Aastra Web UI.

Configuring Display of DTMF Digits



Aastra Web UI

Use the following procedure to configure the display of DTMF digits on the IP phone.



Note: "Display DTMF Digits" is disabled by default.

1. Click on **Basic Settings->Preferences->General.**

The screenshot shows the 'Preferences' window with the 'General' tab selected. The following table represents the visible settings:

Setting	Value/Status
Suppress DTMF Playback	<input checked="" type="checkbox"/> Enabled
Display DTMF Digits	<input type="checkbox"/> Enabled
Play Call Waiting Tone	<input checked="" type="checkbox"/> Enabled
Stuttered Dial Tone	<input checked="" type="checkbox"/> Enabled
XML Beep Support	<input checked="" type="checkbox"/> Enabled
Status Scroll Delay (seconds)	5
Incoming Call Interrupts Dialing	<input type="checkbox"/> Enabled
Switch UI Focus To Ringing Line	<input checked="" type="checkbox"/> Enabled
Call Hold Reminder During Active Calls	<input type="checkbox"/> Enabled
Call Hold Reminder	<input type="checkbox"/> Enabled
Call Waiting Tone Period	0
Preferred line	1
Preferred line Timeout (seconds)	0
Goodbye Key Cancels Incoming Call	<input checked="" type="checkbox"/> Enabled
Message Waiting Indicator Line	All
DND Key Mode	Phone
Call Forward Key Mode	Account

2. Enable the "**Display DTMF Digits**" field by checking the check box. Disable this field by unchecking the box). Default is disabled.
3. Click **Save Settings**.

Call Waiting Tone Period

You can specify a specific time period (in seconds) for the call waiting tone to play at regular intervals on an active call using the parameter “**Call Waiting Tone Period**”. A value of “0” is the default and plays the call waiting tone only once on the active call. When the incoming caller hangs up, the call waiting tone stops on the existing active call.

You can enable or disable this feature in the Aastra Web UI.

Configuring Call Waiting Tone

Use the following procedure to configure “Call Waiting Tone Period”..

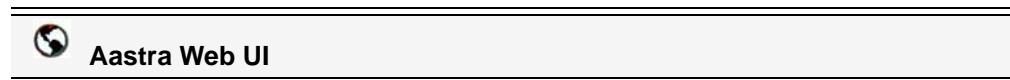

1. Click on **Basic Settings->Preferences->General**

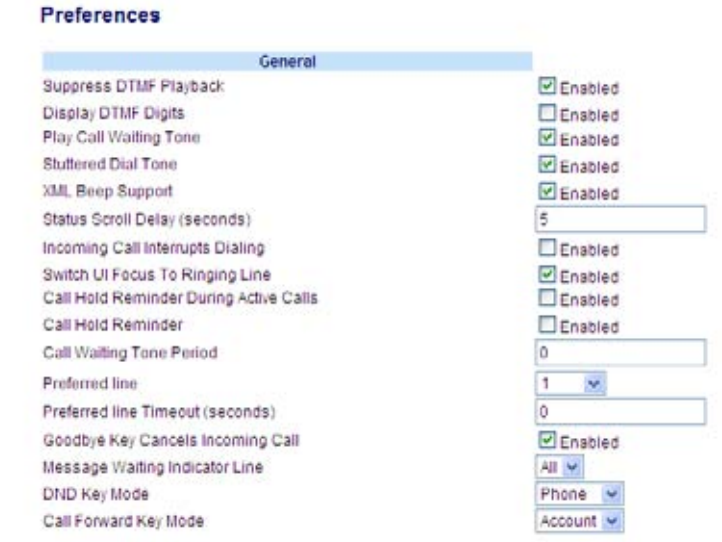

Preferences	
General	
Suppress DTMF Playback	<input checked="" type="checkbox"/> Enabled
Display DTMF Digits	<input type="checkbox"/> Enabled
Play Call Waiting Tone	<input checked="" type="checkbox"/> Enabled
Stuttered Dial Tone	<input checked="" type="checkbox"/> Enabled
XML Beep Support	<input checked="" type="checkbox"/> Enabled
Status Scroll Delay (seconds)	<input type="text" value="5"/>
Incoming Call Interrupts Dialing	<input type="checkbox"/> Enabled
Switch UI Focus To Ringing Line	<input checked="" type="checkbox"/> Enabled
Call Hold Reminder During Active Calls	<input type="checkbox"/> Enabled
Call Hold Reminder	<input type="checkbox"/> Enabled
Call Waiting Tone Period	<input type="text" value="0"/>
Preferred line	<input type="text" value="1"/>
Preferred line Timeout (seconds)	<input type="text" value="0"/>
Goodbye Key Cancels Incoming Call	<input checked="" type="checkbox"/> Enabled
Message Waiting Indicator Line	<input type="text" value="All"/>
DND Key Mode	<input type="text" value="Phone"/>
Call Forward Key Mode	<input type="text" value="Account"/>

2. In the "**Call Waiting Tone Period**" field, enter a time period, in seconds, that the call waiting tone will be audible on an active call when another call comes in. Default is 0 seconds.
3. When enabled, the call waiting tone plays at regular intervals for the amount of time set for this parameter. For example, if set to “30” the call waiting tone plays every 30 seconds. When set to “0”, the call waiting tone is audible only once on the active call.
4. Click **Save Settings**.

Stuttered Dial Tone

You can enable or disable the playing of a stuttered dial tone when there is a message waiting on the IP phone.

You can configure this feature using the Aastra Web UI.

Configuring Stuttered Dial Tone



Aastra Web UI

Use the following procedures to configure stuttered dial tone on the IP phone.



Note: "Stuttered Dial Tone" is enabled by default.

1. Click on **Basic Settings->Preferences->General**.

Preferences	
General	
Suppress DTMF Playback	<input checked="" type="checkbox"/> Enabled
Display DTMF Digits	<input type="checkbox"/> Enabled
Play Call Waiting Tone	<input checked="" type="checkbox"/> Enabled
Stuttered Dial Tone	<input checked="" type="checkbox"/> Enabled
XML Beep Support	<input checked="" type="checkbox"/> Enabled
Status Scroll Delay (seconds)	<input type="text" value="5"/>
Incoming Call Interrupts Dialing	<input type="checkbox"/> Enabled
Switch UI Focus To Ringing Line	<input checked="" type="checkbox"/> Enabled
Call Hold Reminder During Active Calls	<input type="checkbox"/> Enabled
Call Hold Reminder	<input type="checkbox"/> Enabled
Call Waiting Tone Period	<input type="text" value="0"/>
Preferred line	<input type="text" value="1"/>
Preferred line Timeout (seconds)	<input type="text" value="0"/>
Goodbye Key Cancels Incoming Call	<input checked="" type="checkbox"/> Enabled
Message Waiting Indicator Line	<input type="text" value="All"/>
DND Key Mode	<input type="text" value="Phone"/>
Call Forward Key Mode	<input type="text" value="Account"/>

2. Stuttered dial tone is enabled by default. If required, disable the "**Stuttered Dial Tone**" field by unchecking the check box.
3. Click **Save Settings**.

XML Beep Support

Using the Aastra Web UI, you can enable or disable a beep to be audible when the phone receives an XML application using the "**XML Beep Support**" field at the path *Basic Settings->Preferences->General*. If you disable this feature, then no beep is heard when the XML application arrives to the phone.

If your System Administrator has set a value for this feature in a custom XML application or in the configuration files, the value you set in the Aastra Web UI overrides the Administrator's setting. Setting and saving the value in the Aastra Web UI applies to the phone immediately.

Configuring XML Beep Support



Aastra Web UI

Use the following procedures to configure an XML beep on the IP phone.



Note: "XML Beep Support" is enabled by default.

1. Click on **Basic Settings->Preferences->General**.

Preferences	
General	
Suppress DTMF Playback	<input checked="" type="checkbox"/> Enabled
Display DTMF Digits	<input type="checkbox"/> Enabled
Play Call Waiting Tone	<input checked="" type="checkbox"/> Enabled
Stuttered Dial Tone	<input checked="" type="checkbox"/> Enabled
XML Beep Support	<input checked="" type="checkbox"/> Enabled
Status Scroll Delay (seconds)	<input type="text" value="5"/>
Incoming Call Interrupts Dialing	<input type="checkbox"/> Enabled
Switch UI Focus To Ringing Line	<input checked="" type="checkbox"/> Enabled
Call Hold Reminder During Active Calls	<input type="checkbox"/> Enabled
Call Hold Reminder	<input type="checkbox"/> Enabled
Call Waiting Tone Period	<input type="text" value="0"/>
Preferred line	<input type="text" value="1"/>
Preferred line Timeout (seconds)	<input type="text" value="0"/>
Goodbye Key Cancels Incoming Call	<input checked="" type="checkbox"/> Enabled
Message Waiting Indicator Line	<input type="text" value="All"/>
DND Key Mode	<input type="text" value="Phone"/>
Call Forward Key Mode	<input type="text" value="Account"/>

2. "XML Beep Support" is enabled by default. If required, disable the "**XML Beep Support**" field by unchecking the check box.
3. Click **Save Settings**.

Call Hold Reminder During Active Calls

The IP phones allow you to enable or disable the ability for the phone to initiate a continuous reminder tone on the active call when another call is on hold. For example, when this feature is enabled, and the call on Line 1 is on hold, and then the you answer a call on Line 2 and stay on that line, a reminder tone is played in the active audio path on Line 2 to remind you that there is still a call on hold on Line 1.

When this feature is disabled, a ring splash is heard when the active call hangs up and there is still a call on hold.

You can enable or disable this feature using the “**Call Hold Reminder During Active Calls**” in the Aastra Web UI.

Configuring “Call Hold Reminder During Active Calls”

Use the following procedure to configure “Call Hold Reminder During Active Calls” on the IP phone.



Note: "Call Hold Reminder During Active Calls" is disabled by default.



Aastra Web UI

1. Click on **Basic Settings->Preferences->General**

Preferences	
General	
Suppress DTMF Playback	<input checked="" type="checkbox"/> Enabled
Display DTMF Digits	<input type="checkbox"/> Enabled
Play Call Waiting Tone	<input checked="" type="checkbox"/> Enabled
Stuttered Dial Tone	<input checked="" type="checkbox"/> Enabled
XML Beep Support	<input checked="" type="checkbox"/> Enabled
Status Scroll Delay (seconds)	<input type="text" value="5"/>
Incoming Call Interrupts Dialing	<input type="checkbox"/> Enabled
Switch UI Focus To Ringing Line	<input checked="" type="checkbox"/> Enabled
Call Hold Reminder During Active Calls	<input type="checkbox"/> Enabled
Call Hold Reminder	<input type="checkbox"/> Enabled
Call Waiting Tone Period	<input type="text" value="0"/>
Preferred line	<input type="text" value="1"/>
Preferred line Timeout (seconds)	<input type="text" value="0"/>
Goodbye Key Cancels Incoming Call	<input checked="" type="checkbox"/> Enabled
Message Waiting Indicator Line	<input type="text" value="All"/>
DND Key Mode	<input type="text" value="Phone"/>
Call Forward Key Mode	<input type="text" value="Account"/>

2. The “**Call Hold Reminder During Active Calls**” field is disabled by default. To enable this field, check the box.
When this feature is enabled, a reminder tone is heard on the active call when another call is on hold. When disabled, a ring splash is heard when the active call hangs up and there is still a call on hold.
3. Click **Save Settings**

Call Hold Reminder (on single hold)

In previous releases, the call hold reminder ring splash was triggered when you hung up a call and there was at least one other call on hold. The reminder ring splash timer started only when the active call hung up and there was still another call on hold.

On the IP phones, you can enable or disable a feature that would start the reminder ring splash timer as soon as you put a call on hold (even when no other calls are active on the phone). When enabled, the phone initiates a reminder ring splash periodically for the single call on hold. When disabled, no reminder ring splash is audible.

You can enable or disable this feature using the “**Call Hold Reminder**” parameter in the Aastra Web UI.

Configuring “Call Hold Reminder”

Use the following procedure to configure “Call Hold Reminder” on the IP phone.



Note: "Call Hold Reminder" is disabled by default.



Aastra Web UI

1. Click on **Basic Settings->Preferences->General**

The screenshot shows the 'Preferences' page with the 'General' tab selected. The 'Call Hold Reminder' option is currently disabled, indicated by an unchecked checkbox. Other options include 'Suppress DTMF Playback', 'Display DTMF Digits', 'Play Call Waiting Tone', 'Stuttered Dial Tone', 'XML Beep Support', 'Status Scroll Delay (seconds)', 'Incoming Call Interrupts Dialing', 'Switch UI Focus To Ringing Line', 'Call Hold Reminder During Active Calls', 'Call Waiting Tone Period', 'Preferred line', 'Preferred line Timeout (seconds)', 'Goodbye Key Cancels Incoming Call', 'Message Waiting Indicator Line', 'DND Key Mode', and 'Call Forward Key Mode'.

Setting	Value
Suppress DTMF Playback	<input checked="" type="checkbox"/> Enabled
Display DTMF Digits	<input type="checkbox"/> Enabled
Play Call Waiting Tone	<input checked="" type="checkbox"/> Enabled
Stuttered Dial Tone	<input checked="" type="checkbox"/> Enabled
XML Beep Support	<input checked="" type="checkbox"/> Enabled
Status Scroll Delay (seconds)	5
Incoming Call Interrupts Dialing	<input type="checkbox"/> Enabled
Switch UI Focus To Ringing Line	<input checked="" type="checkbox"/> Enabled
Call Hold Reminder During Active Calls	<input type="checkbox"/> Enabled
Call Hold Reminder	<input type="checkbox"/> Enabled
Call Waiting Tone Period	0
Preferred line	1
Preferred line Timeout (seconds)	0
Goodbye Key Cancels Incoming Call	<input checked="" type="checkbox"/> Enabled
Message Waiting Indicator Line	All
DND Key Mode	Phone
Call Forward Key Mode	Account

2. The “**Call Hold Reminder**” field is disabled by default. To enable this field, check the box. When this feature is enabled, the reminder ring splash timer starts as soon as you put a call on hold (even when no other calls are active on the phone). The phone initiates a reminder ring splash periodically for the single call on hold. When disabled, no reminder ring splash is audible.
3. Click **Save Settings**.

Status Scroll Delay

Using the Aastra Web UI, you can specify a scroll delay option that allows you to set the time delay, in seconds, between the scrolling of each status message on the phone. You can specify this setting in the "**Status Scroll Delay (seconds)**" field at the path *Basic Settings->Preferences->General*. The default time is 5 seconds for each message to display before scrolling to the next message. You can increase or decrease this time as required. Setting and saving the value in the Aastra Web UI applies to the phone immediately.

Configuring Status Scroll Delay



Aastra Web UI

Use the following procedures to specify a status scroll delay on the IP phone.

1. Click on **Basic Settings->Preferences->General**.

Preferences	
General	
Suppress DTMF Playback	<input checked="" type="checkbox"/> Enabled
Display DTMF Digits	<input type="checkbox"/> Enabled
Play Call Waiting Tone	<input checked="" type="checkbox"/> Enabled
Stuttered Dial Tone	<input checked="" type="checkbox"/> Enabled
XML Beep Support	<input checked="" type="checkbox"/> Enabled
Status Scroll Delay (seconds)	<input type="text" value="5"/>
Incoming Call Interrupts Dialing	<input type="checkbox"/> Enabled
Switch UI Focus To Ringing Line	<input checked="" type="checkbox"/> Enabled
Call Hold Reminder During Active Calls	<input type="checkbox"/> Enabled
Call Hold Reminder	<input type="checkbox"/> Enabled
Call Waiting Tone Period	<input type="text" value="0"/>
Preferred line	<input type="text" value="1"/>
Preferred line Timeout (seconds)	<input type="text" value="0"/>
Goodbye Key Cancels Incoming Call	<input checked="" type="checkbox"/> Enabled
Message Waiting Indicator Line	<input type="text" value="All"/>
DND Key Mode	<input type="text" value="Phone"/>
Call Forward Key Mode	<input type="text" value="Account"/>

2. Enter a value in the "**Status Scroll Delay (seconds)**" field. Valid values are: 1 to 25 seconds. Default is 5.
3. Click **Save Settings**.

Incoming Call Interrupts Dialing

The 6753i has a feature you can enable or disable called "**Incoming Call Interrupts Dialing**". This feature is disabled by default. If you are dialing out on your phone, and you receive an incoming call at the same time, the incoming call goes to an available line and the LED blinks to let you know where the call was placed by the phone. If there is no line available to take the call, a busy signal is sent to the caller. The LCD continues to display the number you were dialing.

If "**Incoming Call Interrupts Dialing**" is enabled, the incoming call interrupts your dialing sequence and displays to the phone's LCD for you to answer. You have a choice to ignore the incoming call. If you choose to answer the incoming call, you can answer the call, finish the call, and then hang up. You can still go back to the original outgoing call and finish dialing out.

You can enable or disable this parameter in the Aastra Web UI at the path *Basic Settings->Preferences->General*.



Notes:

1. On a 6753i, you must use the down arrow key to ignore the call. To answer the call, lift the handset or press the Speaker Key.
 2. If you disable this field, and the phone receives an incoming call while you are dialing an outgoing call, you can pick up the call and perform transfer or conference as required.
-

Transfer/Conference Call Behavior

If you are dialing the phone to transfer or conference a call, and your phone receives an incoming call, your dialing is never interrupted (regardless of whether the "**Incoming Call Interrupts Dialing**" is enabled or disabled). For Transfer and Conference, the incoming calls always go to an available line (other than the one you are using for dialing) and the incoming call's line LED blinks. The LCD still displays your dialing screen.

Intercom Behavior

If "**Incoming Call Interrupts Dialing**" is enabled and you are dialing an outgoing Intercom call, the enabled interrupt setting takes precedence over an enabled "Allow Barge In" setting. The incoming call interrupts your dialing on an outgoing intercom call. On an incoming intercom call, the enabled "Allow Barge In" and "Auto-Answer" occurs while you are dialing to transfer or conference the call. However, the incoming call goes to an available idle line, and the LED blinks while you are dialing the second half of the conference or transfer.

If "**Incoming Call Interrupts Dialing**" is disabled, an incoming intercom goes to an available idle line and the LED blinks for that line. The phone answers the call under all conditions.

Configuring "Incoming Call Interrupts Dialing"



Aastra Web UI

Use the following procedures to configure "Incoming Call Interrupts Dialing" on the IP Phone.



Note: "Incoming Call Interrupts Dialing" is disabled by default.

1. Click on **Basic Settings->Preferences->General**.

The screenshot shows the 'Preferences' window with the 'General' tab selected. The 'Incoming Call Interrupts Dialing' option is currently disabled, as indicated by the unchecked checkbox. Other settings include 'Suppress DTMF Playback' (checked), 'Display DTMF Digits' (unchecked), 'Play Call Waiting Tone' (checked), 'Stuttered Dial Tone' (checked), 'XML Beep Support' (checked), 'Status Scroll Delay (seconds)' (5), 'Switch UI Focus To Ringing Line' (checked), 'Call Hold Reminder During Active Calls' (unchecked), 'Call Hold Reminder' (unchecked), 'Call Waiting Tone Period' (0), 'Preferred line' (1), 'Preferred line Timeout (seconds)' (0), 'Goodbye Key Cancels Incoming Call' (checked), 'Message Waiting Indicator Line' (All), 'DND Key Mode' (Phone), and 'Call Forward Key Mode' (Account).

2. Enable the "**Incoming Call Interrupts Dialing**" field by checking the check box. Disable this field by unchecking the box). Default is disabled.
3. Click **Save Settings**.

Switch UI Focus to Ringing Line

You can configure a feature on the 6753i that controls the behavior of the phone when it receives an incoming call when it is already in a connected call. When a call comes into the phone, and the phone is already on a connected call, the phone switches focus to the ringing line to enable the user to see who is calling them. You can turn off this functionality so that the phone stays focused on the connected call. You can do this using the Switch Focus to Ringing Line parameter in the Aastra Web UI.

Configuring “Switch Focus to Ringing Line” Using the Aastra Web UI



Aastra Web UI

Use the following procedure to enable or disable the “Switch Focus to Ringing Line” using the Aastra Web UI.

1. Click on **Basic Settings->Preferences->General**.

Preferences	
General	
Suppress DTMF Playback	<input checked="" type="checkbox"/> Enabled
Display DTMF Digits	<input type="checkbox"/> Enabled
Play Call Waiting Tone	<input checked="" type="checkbox"/> Enabled
Stuttered Dial Tone	<input checked="" type="checkbox"/> Enabled
XML Beep Support	<input checked="" type="checkbox"/> Enabled
Status Scroll Delay (seconds)	<input type="text" value="5"/>
Incoming Call Interrupts Dialing	<input type="checkbox"/> Enabled
Switch UI Focus To Ringing Line	<input checked="" type="checkbox"/> Enabled
Call Hold Reminder During Active Calls	<input type="checkbox"/> Enabled
Call Hold Reminder	<input type="checkbox"/> Enabled
Call Waiting Tone Period	<input type="text" value="0"/>
Preferred line	<input type="text" value="1"/>
Preferred line Timeout (seconds)	<input type="text" value="0"/>
Goodbye Key Cancels Incoming Call	<input checked="" type="checkbox"/> Enabled
Message Waiting Indicator Line	<input type="text" value="All"/>
DND Key Mode	<input type="text" value="Phone"/>
Call Forward Key Mode	<input type="text" value="Account"/>

2. The “**Switch Focus to Ringing Line**” field is enabled by default. To disable this field, uncheck the box.
3. Click **Save Settings**.

Preferred Line and Preferred Line Timeout

The 6753i has a feature called “preferred line” and “preferred line timeout”. If you enable the preferred line parameter on your phone, after a call ends (incoming or outgoing), the display switches back to the preferred line. Next time you go off-hook to make another call, you pickup on the preferred line. You can enable the **preferred line** parameter using the Aastra Web UI at the location, **Basic Settings->Preferences->General**. You can also set a **preferred timeout** parameter that specifies the number of seconds it takes for the phone to switch back to the preferred line.



Note: You can configure “Preferred Line” and “Preferred Line Timeout” using the Aastra Web UI only.

The following table provides the behavior of the preferred line focus feature with other features on the phone.

Phone Feature	Preferred Line Behavior
call return	The phone switches back to the focused line immediately after the call ends.
speed dial	The line is already specified when the speed dial is created. The phone switches back immediately after the call ends.
conference	For incoming calls, the phone switches back immediately after the call ends.
transfer	For incoming or outgoing calls, the current behavior is that the same line used to transfer the call does not change. For incoming calls, the phone switches back immediately after the call transfers.
blf	The phone switches back immediately after the call ends.
park	The phone switches back immediately after the call ends.
voicemail	The phone switches back immediately after the call ends.
redial	The phone switches back immediately after the call ends.
dialing	For incomplete dialing on a non-preferred line, the focus does not change if some digits are entered. If no digits are entered or digits were cleared, the focus changes to preferred line after the time out has passed without activities.
caller id	If the "Switch UI Focus To Ringing Line" parameter is disabled, the User is able to see the Caller ID when the phone switches the focus to the ringing line.
factory default	Factory default and recovery mode clears the "preferred line" and "preferred line timeout" parameters, and the phone operates in a non-preferred line mode.



Notes:

1. If you specify a value of “0” for the **preferred line** parameter, it disables the preferred line focus feature.
2. If you specify a value of “0” for the **preferred line timeout** parameter, the phone returns the line to the preferred line immediately.

Configuring “Preferred Line” and “Preferred Line Timeout” Using the Aastra Web UI



Aastra Web UI

Use the following procedure to configure the Preferred Line and Preferred Line Timeout feature using the Aastra Web UI.

1. Click on **Basic Settings->Preferences->General**.

The screenshot shows the 'Preferences' page with the 'General' tab selected. The 'Preferred line' dropdown menu is set to '1' and the 'Preferred line Timeout (seconds)' text box is set to '0'. Other settings include 'Suppress DTMF Playback' (checked), 'Display DTMF Digits' (unchecked), 'Play Call Waiting Tone' (checked), 'Stuttered Dial Tone' (checked), 'XML Beep Support' (checked), 'Status Scroll Delay (seconds)' (5), 'Incoming Call Interrupts Dialing' (unchecked), 'Switch UI Focus To Ringing Line' (checked), 'Call Hold Reminder During Active Calls' (unchecked), 'Call Hold Reminder' (unchecked), 'Call Waiting Tone Period' (0), 'Goodbye Key Cancels Incoming Call' (checked), 'Message Waiting Indicator Line' (All), 'DND Key Mode' (Phone), and 'Call Forward Key Mode' (Account).

2. In the “**Preferred Line**” field, select a preferred line to switch focus to after incoming or outgoing calls end on the phone. Default is **1**. Valid values are:

- **None** (disables the preferred line focus feature)
- **1 to 9**

For example, if you set the preferred line to “1”, when a call (incoming or outgoing) ends on the phone (on any line), the phone switches focus back to Line 1.

3. In the “**Preferred Line Timeout**” field, enter the amount of time, in seconds, that the phone switches back to the preferred line after a call (incoming or outgoing) ends on the phone, or after a duration of inactivity on an active line. Default is **0**. Valid values are:

- **0 to 999**

4. Click **Save Settings**.

Goodbye Key Cancels Incoming Calls

The 6753i has a feature that allows you to configure the **Goodbye** key to drop a second incoming call or ignore incoming calls presented to the phone when you are on an active call. The parameter is called "**Goodbye Key Cancels Incoming Call**" and is configurable via the Aastra Web UI.

If you enable this parameter, which is the default, pressing the Goodbye key rejects calls coming into the phone while you are on an active call. When you disable this parameter, pressing the Goodbye key hangs up the active call.

If you disable this feature, and the phone receives another call when an active call is already present, the 6753i displays "3 **Ignore Answer** 4" on the LCD. For the 6753i, you must use the **Right** and **Left** arrow keys to answer or ignore the call.

A User can set this parameter using only the Aastra Web UI.

Configuring Goodbye Key to Cancel Incoming Calls



Aastra Web UI

Use the following procedure to configure the Goodbye key to cancel incoming calls on the IP Phone.



Note: "Goodbye Key Cancels Incoming Call" is enabled by default.

1. Click on **Basic Settings->Preferences->General**.

Preferences	
General	
Suppress DTMF Playback	<input checked="" type="checkbox"/> Enabled
Display DTMF Digits	<input type="checkbox"/> Enabled
Play Call Waiting Tone	<input checked="" type="checkbox"/> Enabled
Stuttered Dial Tone	<input checked="" type="checkbox"/> Enabled
XML Beep Support	<input checked="" type="checkbox"/> Enabled
Status Scroll Delay (seconds)	5
Incoming Call Interrupts Dialing	<input type="checkbox"/> Enabled
Switch UI Focus To Ringing Line	<input checked="" type="checkbox"/> Enabled
Call Hold Reminder During Active Calls	<input type="checkbox"/> Enabled
Call Hold Reminder	<input type="checkbox"/> Enabled
Call Waiting Tone Period	0
Preferred line	1
Preferred line Timeout (seconds)	0
Goodbye Key Cancels Incoming Call	<input checked="" type="checkbox"/> Enabled
Message Waiting Indicator Line	All
DND Key Mode	Phone
Call Forward Key Mode	Account

2. The "**Goodbye Key Cancels Incoming Call**" field is enabled by default. If required, disable this field by unchecking the check box.

3. Click **Save Settings**.

Using the Goodbye Key to Cancel Incoming Calls Feature



IP Phone UI

IF	THEN
"Goodbye Key Cancels Incoming Call" is enabled AND a second call comes in while you are on an active call,	press the Goodbye key to reject the second incoming call.
"Goodbye Key Cancels Incoming Call" is disabled AND a second call comes in while you are on an active call,	press the Goodbye key to hang up on the active call so you can answer the second incoming call.
"Goodbye Key Cancels Incoming Call" is disabled AND a second call comes in while you are on an active call,	press the Left Arrow 3 key to ignore the second incoming call and remain on the active call OR press the Right Arrow 4 key to answer the second incoming call.

Message Waiting Indicator

You can configure the Message Waiting Indicator (MWI) to illuminate for a specific line or for all lines. For example, if you configure the MWI LED on line 3 only, the LED illuminates if a voice mail is pending on line 3. If you configure the MWI LED for all lines, the LED illuminates if a voice mail is pending on any line on the phone (lines 1 through 9).

You configure the MWI indicator using the Aastra Web UI.

Configuring Message Waiting Indicator



Aastra Web UI

Use the following procedure to configure the message waiting indicator on a specific line or on all lines on the IP phone.



Note: "Message Waiting Indicator Line" parameter is set to **ALL** lines by default.

1. Click on **Basic Settings->Preferences->General**.

Preferences	
General	
Suppress DTMF Playback	<input checked="" type="checkbox"/> Enabled
Display DTMF Digits	<input type="checkbox"/> Enabled
Play Call Waiting Tone	<input checked="" type="checkbox"/> Enabled
Stuttered Dial Tone	<input checked="" type="checkbox"/> Enabled
XML Beep Support	<input checked="" type="checkbox"/> Enabled
Status Scroll Delay (seconds)	<input type="text" value="5"/>
Incoming Call Interrupts Dialing	<input type="checkbox"/> Enabled
Switch UI Focus To Ringing Line	<input checked="" type="checkbox"/> Enabled
Call Hold Reminder During Active Calls	<input type="checkbox"/> Enabled
Call Hold Reminder	<input type="checkbox"/> Enabled
Call Waiting Tone Period	<input type="text" value="0"/>
Preferred line	<input type="text" value="1"/>
Preferred line Timeout (seconds)	<input type="text" value="0"/>
Goodbye Key Cancels Incoming Call	<input checked="" type="checkbox"/> Enabled
Message Waiting Indicator Line	<input type="text" value="All"/>
DND Key Mode	<input type="text" value="Phone"/>
Call Forward Key Mode	<input type="text" value="Account"/>

2. The "**Message Waiting Indicator Line**" field is set to **ALL** lines by default. If required, change the setting to a specific line by selecting a line from the list. Valid values are **All** and lines **1** through **9**.
3. Click **Save Settings**.

Incoming Intercom Call Features

Incoming Intercom

By default, the IP phone allows incoming intercom calls to be automatically answered without having to set up an Icom key on your phone. The phone automatically plays a warning tone when it receives an incoming intercom call. It also mutes the microphone. If the intercom call comes into the phone while an active call is already present, the phone puts the active call on hold and answers the intercom call.

You can change the behavior of how the phone handles incoming intercom calls by enabling/disabling specific parameters using the Aastra Web UI. The following table describes these features.

Incoming Intercom Features in Aastra Web UI	Description
Microphone Mute	Allows you to enable or disable the microphone on the IP phone for Intercom calls made by the originating caller.
Auto Answer	Allows you to enable or disable the IP phone to automatically answer an Intercom call. If auto-answer is enabled on the IP phone, the phone plays a tone (if " Play Warning Tone " is enabled) to alert the user before answering the intercom call. If auto-answer is disabled, the phone rejects the incoming intercom call and sends a busy signal to the caller. Note: Your Administrator can set a time period delay before the phone automatically answers. Contact your System Administrator for more information.
Play Warning Tone	Allows you to enable or disable a warning tone to play when the phone receives an incoming intercom call on an active line.
Allow Barge In	Allows you to enable or disable how the phone handles incoming intercom calls while the phone is on an active call.

Microphone Mute

You can mute or unmute the microphone on the IP phone for intercom calls made by the originating caller. If you want to mute the intercom call, you enable this feature. If you want to unmute (or hear the intercom call), you disable this feature. "**Microphone Mute**" is enabled by default.

Auto-Answer/Play Warning Tone

The auto-answer feature on the IP phone allows you to enable or disable automatic answering for an Intercom call. If “Auto-Answer” is enabled, the phone automatically answers an incoming intercom call. If “Play Warning Tone” is also enabled, the phone plays a tone to alert you before answering the intercom call. If “Auto-Answer” is disabled, the phone rejects the incoming intercom call and sends a busy signal to the caller. **"Auto-Answer"** and **"Play Warning Tone"** are enabled by default.



Note: Your Administrator can set a time period delay before the phone automatically answers. Contact your System Administrator for more information.

Allow Barge In

You can configure whether or not the IP phone allows an incoming intercom call to interrupt an active call. The “Allow Barge In” parameter controls this feature. When you enable this parameter, which is the default value, an incoming intercom call takes precedence over any active call, by placing the active call on hold and automatically answering the intercom call. When you disable this parameter, and there is an active call, the phone treats an incoming intercom call like a normal call and plays the call warning tone. **"Allow Barge In"** is enabled by default.

Configuring Incoming Intercom Settings



Aastra Web UI

Use the following procedure to configure incoming Intercom settings on the IP phone.

1. Click on **Basic Settings->Preferences->Incoming Intercom Settings**.

Incoming Intercom Settings	
Auto-Answer	<input checked="" type="checkbox"/> Enabled
Microphone Mute	<input checked="" type="checkbox"/> Enabled
Play Warning Tone	<input checked="" type="checkbox"/> Enabled
Allow Barge In	<input checked="" type="checkbox"/> Enabled

2. The **"Auto-Answer"** field is enabled by default. The automatic answering feature is turned on for the IP phone for answering Intercom calls. To disable this field, uncheck the box.



Note: If the Auto-Answer field is not checked (disabled), the phone rejects the incoming intercom call and sends a busy signal to the caller.

3. The **"Microphone Mute"** field is enabled by default. The microphone is muted on the IP phone for Intercom calls made by the originating caller. To disable this field, uncheck the box.

4. The "**Play Warning Tone**" field is enabled by default. If "Auto-Answer" is enabled, the phone plays a warning tone when it receives an incoming intercom call. To disable this field, uncheck the box.
5. The "**Allow Barge In**" field is enabled by default. If "Allow Barge In" is enabled, the phone puts an active call on hold and answers the incoming Intercom call. To disable this field, uncheck the box.
6. Click **Save Settings**.

Using Redial Key for "Last Number Redial"

The IP phone has an enhanced redial user interface that allows a user to quickly redial the last number that was dialed out from the phone. You can:

- Press the REDIAL button twice to redial the last number dialed.
- Press the REDIAL button once, scroll the list of numbers, then press the REDIAL button again to dial the number that displays on the screen.

The "last number redial" feature for the Redial key is static and is not configurable.

Group RTP Paging (receives RTP streams)

You can configure the phone to allow it to receive a Real Time Transport Protocol (RTP) stream from pre-configured multicast address(es) without involving SIP signaling. This is called Group Paging on the IP phones. You can specify up to 5 multicast addresses that the phone listens for on the network. This feature is configurable using the Aastra Web UI only.

The 6753i in the local network listens for RTP on the preconfigured multicast address. The Phone displays the “Paging” message to the phone’s LCD. It uses the G711 uLaw CODEC for multicast RTP.

The recipient can drop the incoming page if required. The recipient can also set Do Not Disturb (DND) to ignore any incoming pages.

For incoming RTP multicasts, the ringing display is dependant on the setting for the “**Allow Barge-In**” parameter. (See “[Allow Barge In](#)” on [page 186](#).) If this parameter is disabled, and there is no other call on the phone, then the paging is automatically played via the default audio device.

If there is an existing call on the phone, the call initially displays in the ringing state. The user has the option to accept/ignore the call. If the “**Allow Barge-In**” parameter is enabled, the RTP multicast call barges in, and any existing calls are put on hold.

If an RTP multicast session already exists on the phone, and the phone receives another incoming RTP multicast session, the priority is given to the first multicast session and the second multicast session is ignored. The behavior for the incoming calls in this case is also based on the setting for the “**Allow Barge-in**” parameter. The incoming call is handled as if there were an existing call already on the phone.

Configuring Group RTP Paging



Aastra Web UI

Use the following procedure to configure RTP streaming on the receiving end for Paging applications using the Aastra Web UI.

1. Click on **Basic Settings->Preferences->Group Paging RTP Settings**.

The screenshot shows a web interface with a blue header bar containing the text 'Group Paging RTP Settings'. Below the header, there is a text input field labeled 'Paging Listen Addresses' which is highlighted with a blue rectangular box.

2. In the “**Paging Listen Addresses**” text box, enter the multicast IP address(es) and port number on which the phone listens for incoming multicast RTP packets.

Enter the IP address in dotted decimal format.

(for example, 239.0.1.15:10000,239.0.1.20:15000)

You can enter up to 5 listening multicast addresses.

If this field is blank, the Paging Listening capability is disabled on the phone.



Notes:

1. Recipient of a Paging call can set a global “Do Not Disturb” (DND) to ignore any incoming pages.
2. For incoming Paging, the phone uses the Intercom configuration settings. The incoming Page is dependant on the “Allow Barge-In” parameter setting and the “Idling/On Call” state.

3. Click **Save Settings**.

Shared Call Appearance (SCA) Call Bridging

Shared Call Appearance (SCA) is when incoming calls are presented to multiple phones simultaneously. For example, it is the ability to assign the boss' extension to a button on the secretary's phone. Calls can be transferred between two phones with the same extension button by simply putting the call on hold at one phone and picking it up on the other. Status LEDs light and flash in unison, allowing all people sharing the extension to see the status at a glance.

The phones include an enhanced SCA for the servers that support call bridging and allows two or more SCA users to be connected in a call with a third party.

Refer to the following example.

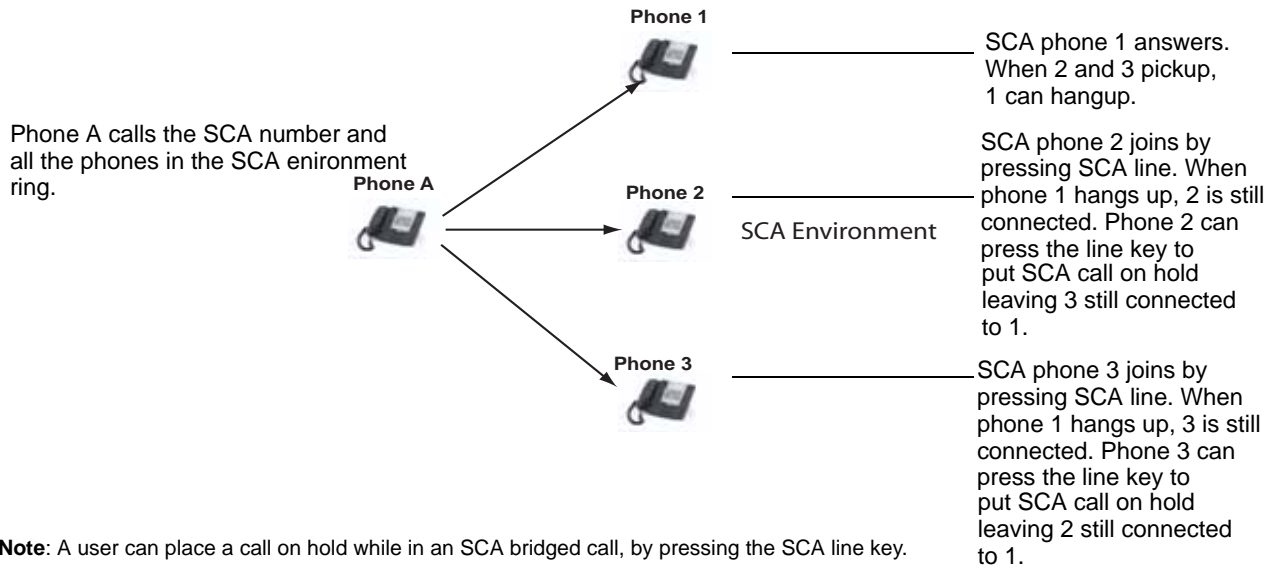

Using the example above, when a call comes into Phone 1, Phone 2 and Phone 3 can pickup the same call by pressing the SCA line key. Phone 2 and 3 display the call they are bridging into on the LCD of the phones. Existing SCA parties in a bridge or one-to-one call hear an audible beep when another party has joined the call.



Note: Your Administrator must enable/disable the beep on the server-side.

If a phone is configured for SCA bridging and it attempts to join a call, but the account on the server does not have this functionality enabled, an error message displays to the LCD on the phone.

The SCA call bridging feature is disabled by default on all phones. Your Administrator can enable/disable this feature if required. Contact your System Administrator for more information.

Keys States and LED Behavior

There are two call states on the phones that support SCA bridging:

- **Bridge-active** - A bridged call is in progress
- **Bridge-held** - The 3rd-party (i.e., non-SCA party) in the bridge is on hold.

The following tables provide the key states and LED behavior in an SCA bridge call for users involved in an SCA call and users not involved in the SCA call.

Line Keys and Idle Screens

State	Call LED	Call Caller ID	Non-Call LED	Non-Call Caller ID
Idle	N/A	N/A	Off	N/A
Seized	Solid Green	None	Solid Red	None
Progressing (outgoing call)	Green	Called Part7	Solid Red	None
Alerting (incoming call)	Blinking Unselected Red	N/A		
Active	Solid Green	Far-end	Solid Red	Far-end
Held	Slow Flashing Green	Far-end	Slow Flashing Red	Far-end
Hold private	Slow Flashing Green	Far-end	Solid Red	Far-end
Bridge-active	Solid Green	Far-end	Solid Red	Far-end
Bridge-held	Slow Flashing Green	Far-end	Solid Red	Far-end

Programmable Line Keys

State	Call Icon	Call LED	Non-Call Icon	Non-Call LED
Idle	Small circle	None	Small circle	None
Seized	N/A	N/A	Sold Circle	Solid Red
Progressing (outgoing call)	Empty circle	Solid Red	Sold Circle	Solid Red
Alerting (incoming call)	Empty blinking circle	Flashing Red	N/A	N/A
Active	Empty circle	Solid Red	Sold Circle	Solid Red
Held	Reverse empty blinking circle	Slow Flashing Red	Sold Reverse Circle	Slow Flashing Red
Hold private	Reverse empty blinking circle	Slow Flashing Red	Sold Circle	Solid Red
Bridge-active	Empty circle	Solid Red	Sold Circle	Solid Red
Bridge-held	Reverse empty blinking circle	Slow Flashing Red	Sold Circle	Solid Red

Line key Phone Behavior

State	Call Line Key Pressed	Non-Call Line Key Pressed
Idle	N/A	Attempt to seize the line
Seized	Hang up	Ignore
Progressing	Hang up	Ignore
Alerting	answer	N/A
Active	Hold	Bridge
Held	Retrieve	Bridge
Hold private	Retrieve	Ignore
Bridge-active	Hold	Bridge
Bridge-held	Retrieve	Bridge

Available Features Enabled by Administrators

There are features on your IP Phone that you can use ONLY if an Administrator has enabled them on your phone. Those features are described in this section. Contact your System Administrator for more information.

Outgoing Intercom Calls

If your System Administrator configures the outgoing intercom feature on your phone, pressing the Icom button allows your phone to find an available line and place an intercom call to a recipient. To use this feature, you must configure an intercom key on your phone. For more information about configuring and using an Icom key, see “[Intercom Key](#)” on [page 102](#).

Missed Call Summary Subscription

A feature on the IP phones allows missed calls that have been redirected by the server, to be incremented in the missed calls indicator on the phone it was initially directed to. This feature is called the **Missed Call Summary Subscription** and can be configured by your System Administrator. For this feature to work, you must configure voicemail on the phone that the call was initially directed to.

For example, phones A, B, and C are connected to the server. Your Administrator configures the server to direct calls coming into phone B (which has voicemail configured) to be forwarded to phone C. When phone A calls phone B, the server forwards the call to phone C. With the **Missed Call Summary Subscription** enabled, phone B receives notification from the server that the call was forwarded and the missed calls indicator is incremented on phone B. See the illustration below.

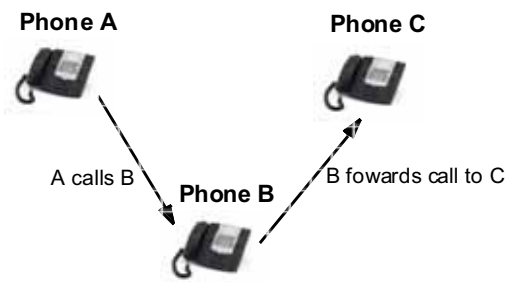

Note: Your System Administrator can configure the **Missed Call Summary Subscription** feature on a global or per-line basis.

Customizable Callers List Key

Your System Administrator can specify an XML URI that creates a custom Callers List application for your phone. When you press the Callers List key, the phone accesses a custom XML URI Callers List instead of the standard Callers List. Contact your System Administrator for more information.

Autodial (Hotline and Warmline)

Your System Administrator can configure an autodial feature on your phone. If autodial is enabled, the phone automatically dials a preconfigured number whenever it is off-hook. Depending on the configuration specified by your Administrator, the Autodial functions as either a “hotline”, or as a “warmline,” as follows:

- **Hotline:** The IP phone immediately dials a preconfigured number when you lift the handset.
- **Warmline:** The IP phone waits for a specified amount of time after you lift the handset before dialing a preconfigured number. If you do not dial a number within the time allotted, then the IP phone begins to dial the number.

The Autodial feature is available on a global or per-line basis. Contact your System Administrator for more information.



Notes:

1. Any speed dial numbers that you configure on your IP phone are not affected by autodial settings.
 2. If Autodial is configured on your phone, any lines that function as hotlines do not accept conference calls, transferred calls, and/or intercom calls.
-

Centralized Conferencing

The 6753i supports centralized conferencing for Sylanro and Broadsoft servers. This feature provides centralized conferencing on the SIP server (versus localized, on the phone). Your System Administrator must enable this feature on your phone before you can use centralized conferencing.

Centralized Conferencing allows you to perform the following:

- Conference two active calls together into a conference call.
- When on an active conference call, invite another party into the call.
- Create simultaneous conference calls on the same IP phone (Sylanro servers only). For example, a user at extension 2005 could create two conferences, and put one conference on hold while conversing with the other party:
 - Line 1: conference together extensions 2005, 2010, and 2020.
 - -Line 2: conference together extensions 2005, 2011 and 2021.
- Disconnect from an active conference call while allowing the other callers to remain connected.
- Add unlimited number of users to a conference (dependent on the limitations of the server).
- Join two active calls together into a conference.
- Join incoming or outgoing active calls to any existing conference.

Reference

For more information about using Centralized Conferencing, see [“Centralized Conferencing \(for Sylanro and Broadsoft Servers\)”](#) on page 123.

Answer and Ignore Keys for XML Applications

If you are accessing XML applications on your phone and a call comes in, your System Administrator can create "**Answer**" and "**Ignore**" keys that you can use to either answer the incoming call, or ignore it.

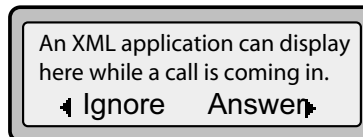

When the 3 Ignore Answer 4 line displays, you can press the **Right Arrow** key (Answer) to answer the incoming call without disturbing the current XML application. When you answer the call, the 3 Ignore Answer 4 line disappears from the LCD. Pressing the **Left Arrow** key (Ignore) ignores the incoming call without disturbing the current XML application. Contact your System Administrator for more information.

Playing a WAV File On Your Phone

If enabled by your Administrator, the 6753i IP Phone can play a WAV file. A WAV file is an audio file format standard for storing an audio bit stream on a system in raw, uncompressed format or compressed format to reduce the file size.

A WAV file is streamed to the phone using the HTTP protocol.

The WAV feature supports the following:

- Streaming of the WAV file to allow it to be locally played
- Allows you to abort the audio streaming by pressing the **Goodbye** key on the phone.
- Supports the HTTP file download protocol
- Supports the aLaw and uLaw codecs
- Plays the WAV file only if the phone is idle.
- WAV audio file starts only when 4 seconds of the audio data (or the complete file) has been accumulated.
- Follows the standard phone behavior of speaker/head set/hand set.

IP Phone UI Screen During WAV Streaming

The 6753i screen displays the following during WAV streaming.

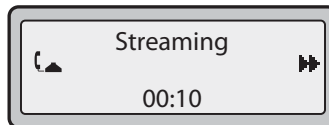

To abort the WAV streaming, press any of the following:

- **Goodbye** key
- **Drop** softkey

You can also place the handset (if in use) on hook.

Using the Keypad During Active XML Applications

If enabled by your Administrator, the 6753i IP Phone can allow you to continue using your keypad keys during active XML applications on your phone. This feature is applicable only when your phone is in the connected state. By default, the phone suppresses dialpad events when an XML object is in focus, so your Administrators must enable the keypad to be used during active XML applications. Contact your System Administrator for more information.

Key Redirection

Conference, Transfer, Redial, Intercom Keys and Voicemail Option

If enabled by your Administrator, the Conference, Transfer, Redial, and Intercom keys, as well as the Voicemail option, can be redirected to XML scripts. This allows the server to provide the phone with Redial, Transfer (Xfer), Conference (Conf), and Intercom (Icom) key features, and the Voicemail option feature, rather than accessing them from the phone-side. By default, the server-side keys function the same as the phone-side key features.



Notes:

1. Key remapping takes precedence over redirecting.
 2. Disabling the redial, conference, or transfer features on the phone also disables the redirection of these keys.
-

Contact your System Administrator for more information about this feature.

Options Key

If enabled by your Administrator, the Services Menu on the 6753i IP Phone can be redirected to an XML script. This allows the server to provide the phone with available options, rather than accessing them from the phone-side. You access the XML script by selecting the Services Menu. You can still access the Services Menu from the phone-side by pressing and holding the Options key to display the phone-side Services Menu.

IMPORTANT NOTES

- If no Options URI script is configured, the local Options Menu on the phone displays as normal.
- If you configure password access to the Options Menu, this password is required when accessing the local Option Menu, but is not required for the Options Key redirection feature.
- Pressing the Options Menu for redirection from the server does not interfere with normal operations of the phone (for example, pressing the options menu when on a call does not affect the call).
- If the phone is locked, you must unlock the phone before accessing the Options Menu redirect feature. After pressing the Options Key, the phone displays a screen that allows you to unlock the phone before continuing.
- On the 6753i, the redirection feature works after selecting the Services Menu. To display the original Options Menu, press and hold the Options key.

Contact your System Administrator for more information about this feature.

XML Applications and Off-Hook Interaction

If enabled by your Administrator, the 6753i can be prevented from going into the off-hook/dialing state when the handset is off-hook and the call ends. This feature is disabled by default and must be enabled by your Administrator. The disabled behavior is as follows:

You are in a call using the handset and the phone displays an XML application. The far-end terminates the call, and a new XML application gets pushed/pulled onto the display. Since the handset is off-hook and in idle mode, the "offhook idle timer" starts. When this timer expires, the phone applies dial tone and moves to the off-hook/dialing state, which then destroys the XML application that was being displayed.

Contact your System Administrator for more information about this feature.

XML Override for a Locked Phone

The 6753i has a feature that allows a locked phone to be overridden when an XML application is sent to the phone. This feature also allows you to still use programmable keys/expansion module keys applicable to the XML application even though the phone is locked. However, any keys NOT associated with the XML application cannot be used when the phone is locked.

Also, XML Get Requests override the locked feature on the phone so that any programmable key pressed by the user that initiates a Get Request continues to get sent.

Only a System Administrator can configure the feature of "XML override for a locked phone".

RTP Recording and Simultaneous Playing

The IP Phones now allow for Real-Time Transport Protocol (RTP) recording and simultaneous playing of an audio file via XML commands created by your Administrator. The RTP and multicast RTP commands allow the phone to send/receive an RTP stream to/from given multicast/unicast addresses (without involving SIP signaling).



Notes:

1. When an RTP stream is being sent with RTP recording and simultaneous playing (mix), the IP Phone LCD displays an icon with an 'm' on top to indicate that a mixed RTP stream is being sent.
 2. When RTP stream is being received with RTP recording and simultaneous playing (mix), you can use the volume controls on the IP phone to adjust the volume (increase or decrease) to your specifications.
-

Contact your System Administrator for more information about this feature.

“Hold” Feature Enhancement (for Broadsoft Servers)

The Hold feature allows you to put an active call on “hold,” then retrieve the call later. This enhancement is intended for IP phones operating with servers that support RFC3264 (for example, Broadsoft). If a server does not support RFC3264, then the IP phones do not use RFC3264 functionality.

Configurable Save and Delete Keys

There are six function keys on the 6753i phone located to the left of the paper label. Your System Administrator can make the **Save** and **Delete** keys (Keys 1 and 2) programmable keys with the same functions that are available for the other programmable keys.

By default, the **Save** key allows you to save entries to the Directory and perform a Save-To from the Callers List. It also allows you to save speed dial information to a programmable key. You can also use the Save key while using specific XML applications.

By default, the **Delete** key allows you to remove entries from the Directory List and Callers List. (Must enter the Directory or Callers list and select an entry, then press twice to delete entry).

Once the **Save** and **Delete** keys are made configurable, you can change the function of the keys using the Aastra Web UI.

IMPORTANT: If you change the functions of the **Save** and **Delete** keys, and then an Administrator locks Keys 1 and 2, the functions are automatically set back to the default settings of "Save" and "Delete".

Authentication Support for HTTP/HTTPS Download Methods Used with Broadsoft Client Management System (CMS)

If enabled by an Administrator, the 6753i has authentication support when using HTTP or HTTPS as download protocols (as per RFC 2617). When a phone is connected to a Broadsoft Server using the CMS tool, a LOGIN key displays. Pressing the LOGIN key displays a login screen with Username and Password. Username can be up to 40 characters and Password can be up to 20 characters. A System Administrator can optionally configure a Domain Name to be used as the Username (e.g. username@domain.com). A user can navigate the screen using the navigation keys (arrow keys) on the phone. The screen provides a SUBMIT key for submission of the field information, and a CANCEL key for exiting the login screen. Appropriate messages display if the phone reaches a timeout while trying to connect to the server, or if a Username or Password are incorrect.

Once the login information for a specific user is entered and accepted by the server, the phone reboots and downloads the user profile.

IP Phone UI when Broadsoft CMS is Enabled

When the Broadsoft CMS feature is enabled on the IP Phone, the following screens display:

Login Screen

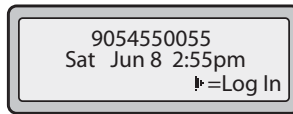

9054550055
Sat Jun 8 2:55pm
=Log In

Username Screen

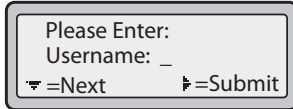

Please Enter:
Username: _
=Next =Submit

Password Screen

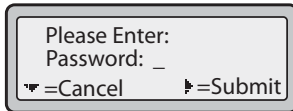

Please Enter:
Password: _
=Cancel =Submit

Diverting Calls from Your Phone

Your Administrator can enable/disable a feature on your phone that allows incoming calls to be diverted to another phone if required.

When an outgoing call from your phone is being diverted to another destination (i.e., via call forward), the phone displays the Caller ID (phone number and/or caller name) of the new destination and the reason for the call diversion. Similarly, at the new destination, the Caller ID of the original call destination displays.

Call Diversion Example	
1	Tim calls Mark at x400.
2	Mark's phone is busy.
3	Mark's phone diverts the incoming call to another destination (Roger @ x 464).
4	Tim's phone displays name and extension of where the call is being diverted to and reason for diverting the call. The screen scrolls between Screen 1 and Screen 2.
5	Roger's phone accepts the call and displays the name and number of the phone the incoming call (Tim) and the name (or number) of the original destination (Mark). The screens scroll between Screen 1 and Screen 2..

See examples of the phones' LCD below.

The diversion LCD screens scroll every 3 seconds.

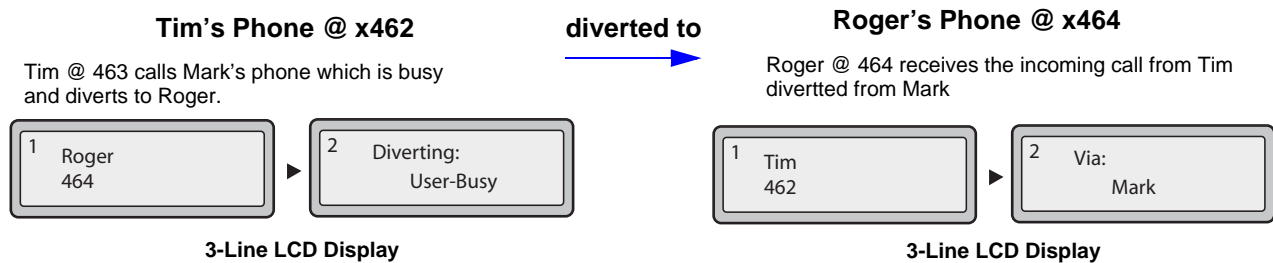

To enable this call diverting feature, contact your System Administrator.

Display of Call Destination Information

By default, your phone displays call destination information if your phone is configured to forward calls to other destinations. The call destination information displays on multiple screens that scroll every 3 seconds. The following example shows call destination information on the 6753i IP Phone.

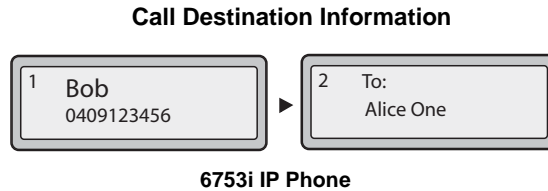

Note: When both call diversion and call destination are enabled, the information displays to the phone's screens in the following order:

- Screen 1** Caller info
 - Screen 2** Call destination
 - Screen 3** Call diversion
-

If your phone does not display call destination information, your System Administrator may have disabled this feature. Contact your System Administrator for more information.

Indication of Terminated Calls

An Administrator can configure your phone to display a disconnected screen (“Call Terminated”) when the far-end hangs up. An audible busy signal is also heard on the phone. The configuration of this feature can also include the maximum time interval that the busy signal is audible. Contact your System Administrator for more information.

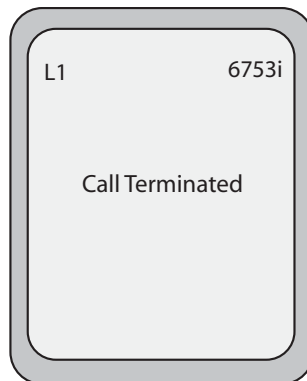

The following is the call terminated screen that displays on the 6753i if this feature is enabled on your phone:

IF	THEN
1 line active and far-end disconnects,	<p>the line in focus:</p> <ul style="list-style-type: none"> • displays disconnected screen. • plays busy tone. • displays "Call Terminated" message on the screen. <p>the line not in focus:</p> <ul style="list-style-type: none"> • plays busy tone.
2 or more lines active, and far-end disconnects,	<p>the line in focus:</p> <ul style="list-style-type: none"> • displays disconnected screen. • plays busy tone. • displays "Call Terminated" message on the screen for 5 seconds. <p>When 5 second times out:</p> <ul style="list-style-type: none"> • the busy tone stops • the disconnected screen disappears.
2 or more lines active, and a line NOT in focus is disconnected by the far-end,	<ul style="list-style-type: none"> • no busy tone plays • no disconnected screen displays • no “Call Terminated” message displays
An incoming call comes in on the line in focus that has a disconnected screen displaying,	<p>the line in focus with no calls on hold:</p> <ul style="list-style-type: none"> • displays a ringing screen <p>the line in focus WITH calls on hold:</p> <ul style="list-style-type: none"> • flashes its' Line LED

IF	THEN
An incoming call comes in on another line (NOT in focus), and the disconnected screen is displaying on the line in focus,	<ul style="list-style-type: none"> the disconnected screen no longer displays on the line in focus.
A phone application is NOT in focus,	<ul style="list-style-type: none"> busy tone plays no disconnected screen displays <p>When the phone application in focus on screen stops:</p> <ul style="list-style-type: none"> busy tone plays disconnected screen displays



Note: This “indication of terminated calls” feature does not affect parked calls on the phone or the conference call feature.

The following procedure describes how to handle the disconnected screens on your phone.



IP Phone UI

For all phones:

- Press the Goodbye  key.
The busy tone stops and the disconnected screen no longer displays.

or

Select any **Line** key.
The busy tone stops and the disconnected screen no longer displays.
A dial screen displays.

Model M670i Expansion Module

The 6753i IP Phone offers an optional M670i Expansion Module that attaches to the right side of the phone to provide additional keys.

Model M670i

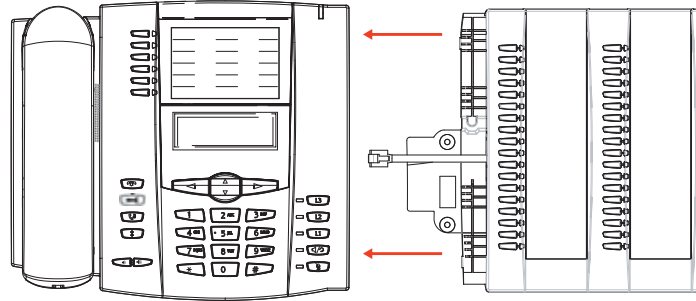

The M670i provides 18 keys in each column (totaling 36 keys) on the keypad. Each key provides an LED for indicating call status. The M670i provides a paper label for convenient key labeling.

The Expansion Module keys support the following functions:

- None
- Line
- Speed dial
- Do not disturb (DND)
- Busy Lamp Field (BLF)
- BLF List
- Auto Call Distribution (ACD)
- Directed Call Pickup
- Extensible Markup Language (XML)
- Flash
- Sprecode
- Park
- Pickup
- Last Call Return (lcr)
- Call Forward
- BLF/Xfer
- Speed Dial/Xfer
- Directory
- Callers List
- Conference
- Transfer
- Intercom
- Services
- Phone Lock
- Paging

You can configure the keys using the Aastra Web UI at the path, *Operation->Expansion Module <N>* when an Expansion Module is attached to the 6753i IP Phone.

Reference

For more information about configuring the expansion module keys with these functions, see the [“Programmable Keys”](#) on page 50.

Using the Expansion Module

M670i Expansion Module

After configuring the keys on the M670i Expansion Module, you can record the name of the key on the paper labels provided with the Expansion Module. Press the key you want to use when applicable.

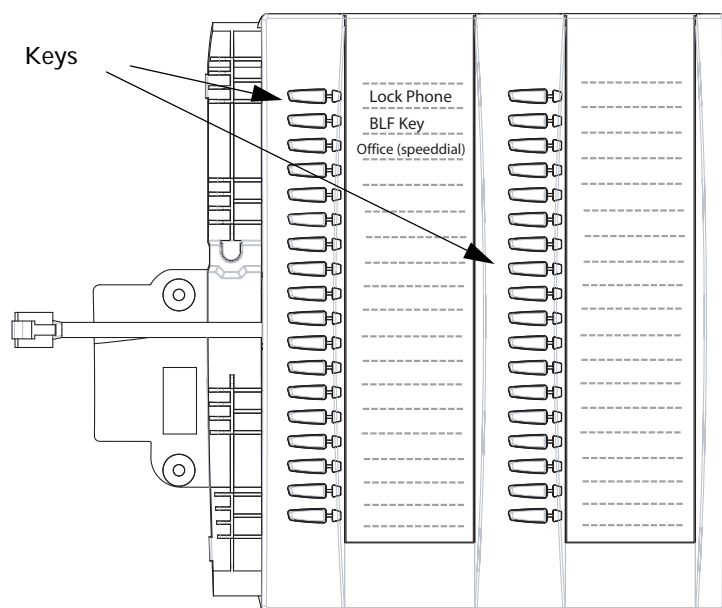

References

For more information about configuring keys, see [“Programmable Keys”](#) on page 50.

For more information about installing the M670i module on your phone, see the *Aastra 6753i IP Phone Installation Guide*.

Press-and-Hold to Create a Speed Dial Key

You can press and hold an expansion module key to create a speed dial key and configure it the same way you configure a speed dial key on the phone.



For a procedure on creating a speed dial key, see [“Press-and-Hold to Create a Speed Dial \(applicable to programmable keys, keypad keys, expansion module keys\)”](#) on page 55.

Troubleshooting Solutions

Why is my display blank?

Ensure that power is being provided to your phone. Make sure your phone is plugged into a power source.

Why is my speakerphone not working?

If you press the  button and the speaker light flashes and you do not hear dial tone through the speaker phone, the Set Audio option in the phone's Options list has been set up for headset use. Press  a second time and if the light goes out, the phone has been set up to be used only with a headset or handset. If the light stays on steady and you hear dial tone, the phone has been set up so that you can alternate between the speakerphone and the headset by pressing . See the section, "[Set Audio](#)" on [page 29](#) for instructions on how to change the Set Audio option.

Why can't I get a dial tone?

Check for any loose connections and that the phone has been installed properly. For installation instructions, please refer to the "**Installation and Setup**" section in the *Aastra 6753i Installation Guide* provided with your phone.

Why doesn't my phone ring?

Check the ring volume on your phone. It may be turned down or turned off. To adjust the ringer volume setting, press the volume button when the phone is on-hook and idle. For more information, refer to the "**Adjusting Volume section**" in the *Aastra 6753i Installation Guide* provided with your phone.

Why is the light not coming on with a new Voice Mail Message?

Your phone system or service provider must provide "Visual" Message Waiting service for this function to work. Check with your System Administrator for more information.

Why is my handset not working?

Check to ensure that the handset cord is fully connected to both the phone and handset. See the section "**Connecting a Handset or Headset**" in the *Aastra 6753i Installation Guide* for information.

How do I find the IP address of my phone?

Instructions on where to find the IP address of your phone can be found in this guide in the section, "[Finding Your Phone's IP Address](#)" on [page 21](#).

Why does my phone display the “No Service” message?

The phone displays the “No Service” message if the SIP settings have not been set up correctly.

Contact your System Administrator for more information.

How do I change my user password?

You can change the user password from the IP phone UI or the Aastra Web UI.



IP Phone UI

1. Press  on the phone to enter the Options List.
2. Select **User Password** and press **Enter**.
3. Enter the current user password and press **Enter**.
4. Enter the new user password and press **Enter**.
5. Re-enter the new user password and press **Enter**.
A message, "Password Changed" displays on the screen.



Aastra Web UI

1. Click on **Operation->User Password**.

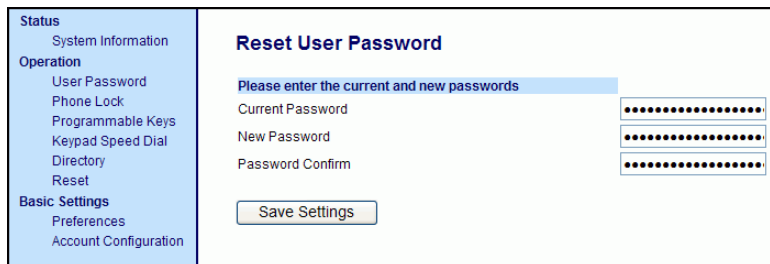

Status System Information	Reset User Password Please enter the current and new passwords Current Password <input type="password"/> New Password <input type="password"/> Password Confirm <input type="password"/> <input type="button" value="Save Settings"/>
Operation User Password Phone Lock Programmable Keys Keypad Speed Dial Directory Reset	
Basic Settings Preferences Account Configuration	

2. In the "Current Password" field, enter the current user password.



Note: By default, the user name is “user” (all lowercase) and the password field is left blank. If you have forgotten your password, contact your System Administrator for assistance.

3. In the "New Password" field, enter the new user password.
4. In the "Password Confirm" field, enter the new user password again.
5. Click **Save Settings**.

For information on how to access the Aastra Web UI, go to the section [“Using the Aastra Web UI”](#) on page 16.

Why does my phone display "Bad Encrypted Config"?

The IP phone displays "Bad Encrypted Config" because encrypted configuration files are enabled but the decryption process has failed.

Report this error to your System Administrator.

How do I restart the IP phone?



IP Phone UI

1. Press the  button on the phone to enter the Option List.
2. Use the 2 key to scroll down the list of options to **Phone Status** and press the 4. key to select.
3. Press the 2 key to scroll to the **Restart Phone** option.

Press the 4. key to confirm and restart the phone. If you do not wish to restart your phone, press the 3 key to cancel.



Note: Your phone is out of service temporarily during the restart and downloading process.



Aastra Web UI

1. Click on **Operation->Reset**.

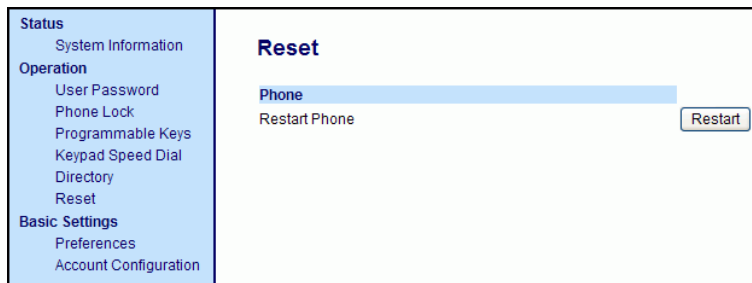

2. Click **Reset**.
3. Click **OK** at the confirmation prompt.

How do I lock my phone?

You can lock your phone to prevent the phone from being used or configured. You can lock the phone using any of the following:



- In the IP Phone UI at the path *Options->Phone Lock*.
- In the Aastra Web UI at the path *Operations->Phone Lock*.
- At a configured Phone Lock key on the phone. For more information about configuring a Lock/Unlock key on your phone, see “[Phone Lock Key](#)” on [page 106](#).

Use the following procedure to lock an IP phone using the IP Phone UI.



IP Phone UI

Lock the Phone

1. Press  on the phone to enter the Options List.
2. Select **Phone Lock** and press **Enter**.
3. Press **4** to set the phone to lock.
4. Press  on the phone.
The following message displays:
"Phone is locked".

Unlock the Phone

1. Press  on the phone to enter the Options List.
2. Enter your user password and press **Enter**.
The phone unlocks.

Use the following procedure to lock an IP Phone using the Aastra Web UI.



Aastra Web UI

1. Click on **Operation->Phone Lock**.

Status System Information	Phone Lock
Operation User Password Phone Lock Programmable Keys Keypad Speed Dial Directory Reset	Lock or unlock the phone Emergency Dial Plan <input type="text" value="911 999 112 110"/> Lock the phone? <input type="button" value="Lock"/> Reset User Password <input type="button" value="Reset"/> <input type="button" value="Save Settings"/>
Basic Settings Preferences Account Configuration	

Lock the Phone

2. In the "**Lock the Phone?**" field, click **Lock**.
The phone locks dynamically and displays the following message:
"Phone is locked".

Unlock the Phone

3. Click on **Operation->Phone Lock**.
4. In the "**Unlock the Phone?**" field, click **Unlock**.
The phone unlocks dynamically and displays the following message:
"Phone is unlocked".

Limited Warranty

Aastra Telecom warrants this product against defects and malfunctions during a one (1) year period from the date of original purchase. If there is a defect or malfunction, Aastra Telecom shall, at its option, and as the exclusive remedy, either repair or replace the telephone set at no charge, if returned within the warranty period.

If replacement parts are used in making repairs, these parts may be refurbished, or may contain refurbished materials. If it is necessary to replace the telephone set, it may be replaced with a refurbished telephone of the same design and color. If it should become necessary to repair or replace a defective or malfunctioning telephone set under this warranty, the provisions of this warranty shall apply to the repaired or replaced telephone set until the expiration of ninety (90) days from the date of pick up, or the date of shipment to you, of the repaired or replacement set, or until the end of the original warranty period, whichever is later. Proof of the original purchase date is to be provided with all telephone sets returned for warranty repairs.

Exclusions

Aastra Telecom does not warrant its telephone sets to be compatible with the equipment of any particular telephone company. This warranty does not extend to damage to products resulting from improper installation or operation, alteration, accident, neglect, abuse, misuse, fire or natural causes such as storms or floods, after the telephone is in your possession.

Aastra Telecom shall not be liable for any incidental or consequential damages, including, but not limited to, loss, damage or expense directly or indirectly arising from the customers use of or inability to use this telephone, either separately or in combination with other equipment. This paragraph, however, shall not apply to consequential damages for injury to the person in the case of telephones used or bought for use primarily for personal, family or household purposes.

This warranty sets forth the entire liability and obligations of Aastra Telecom with respect to breach of warranty, and the warranties set forth or limited herein are the sole warranties and are in lieu of all other warranties, expressed or implied, including warranties or fitness for particular purpose and merchantability.

Warranty Repair Services

Should the set fail during the warranty period;

In North America, please call 1-800-574-1611 for further information.

Outside North America, contact your sales representative for return instructions.

You will be responsible for shipping charges, if any. When you return this telephone for warranty service, you must present proof of purchase.

After Warranty Service

Aastra Telecom offers ongoing repair and support for this product. This service provides repair or replacement of your Aastra Telecom product, at Aastra Telecom's option, for a fixed charge. You are responsible for all shipping charges. For further information and shipping instructions;

In North America, contact our service information number: 1-800-574-1611.

Outside h America, contact your sales representative.



Note: Repairs to this product may be made only by the manufacturer and its authorized agents, or by others who are legally authorized. This restriction applies during and after the warranty period. Unauthorized repair will void the warranty.

Appendix A - Time Zone Codes

The following table identifies the time zone name and time zone code to use on the IP phone.

Time Zone Name/Time Zone Code Table

Time Zone Name	Time Zone Code
AD-Andorra	CET
AE - Dubai	GST
AG-Antigua	AST
AI-Anguilla	AST
AL-Tirane	CET
AN-Curacao	AST
AR-Buenos Aires	ART
AS-Pago Pago	BST
AT-Vienna	CET
AU-Lord Howe	LHS
AU-Tasmania	EST
AU-Melbourne	EST
AU-Sydney	EST
AU-Broken Hill	CST
AU-Brisbane	EST
AU-Lindeman	EST
AU-Adelaide	CST
AU-Darwin	CST
AU-Perth	WST
AW-Aruba	AST
AZ - Baku	AZT
BA-Sarajevo	EET
BB-Barbados	AST
BE-Brussels	CET
BG-Sofia	EET
BM-Bermuda	AST
BO-La Paz	BOT
BR-Noronha	FNT
BR-Belem	BRT
BR-Fortaleza	BRT
BR-Recife	BRT
BR-Araguaina	BRS
BR-Maceio	BRT
BR-Sao Paulo	BRS
BR-Cuiaba	AMS
BR-Porto Velho	AMT
BR-Boa Vista	AMT
BR-Manaus	AMT
BR-Eirunepe	ACT
BR-Rio Branco	ACT
BS-Nassau	EST
BY-Minsk	EET
BZ-Belize	CST

Time Zone Name	Time Zone Code
CA-Newfoundland	NST
CA-Atlantic	AST
CA-Eastern	EST
CA-Saskatchewan	EST
CA-Central	CST
CA-Mountain	MST
CA-Pacific	PST
CA-Yukon	PST
CH-Zurich	CET
CK-Rarotonga	CKS
CL-Santiago	CLS
CL-Easter	EAS
CN-China	CST
CO-Bogota	COS
CR-Costa Rica	CST
CU-Havana	CST
CY-Nicosia	EES
CZ-Prague	CET
DE-Berlin	CET
DK-Copenhagen	CET
DM-Dominica	AST
DO-Santo Domingo	AST
EE-Tallinn	EET
ES-Madrid	CET
ES-Canary	WET
FI-Helsinki	EET
FJ-Fiji	NZT
FK-Stanley	FKS
FO-Faeroe	WET
FR-Paris	CET
GB-London	GMT
GB-Belfast	GMT
GD-Grenada	AST
GE - Tbilisi	GET
GF-Cayenne	GFT
GI-Gibraltar	CET
GP-Guadeloupe	AST
GR-Athens	EET
GS-South Georgia	GST
GT-Guatemala	CST
GU-Guam	CST
GY-Guyana	GYT
HK-Hong Kong	HKS
HN-Tegucigalpa	CST
HR-Zagreb	CET
HT-Port-au-Prince	EST
HU-Budapest	CET
IE-Dublin	GMT
IS-Reykjavik	GMT
IT-Rome	CET
JM-Jamaica	EST
JP-Tokyo	JST

Time Zone Name	Time Zone Code
KY-Cayman	EST
LC-St Lucia	AST
LI-Vaduz	CET
LT-Vilnius	EET
LU-Luxembourg	CET
LV-Riga	EET
MC-Monaco	CET
MD-Chisinau	EET
MK-Skopje	CET
MQ-Martinique	AST
MS-Montserrat	AST
MT-Malta	CET
MU - Mauritius	MUT
MX-Mexico City	CST
MX-Cancun	CST
MX-Merida	CST
MX-Monterrey	CST
MX-Mazatlan	MST
MX-Chihuahua	MST
MX-Hermosillo	MST
MX-Tijuana	PST
NI-Managua	CST
NL-Amsterdam	CET
NO-Oslo	CET
NR-Nauru	NRT
NU-Niue	NUT
NZ-Auckland	NZS
NZ-Chatham	CHA
OM - Muscat	GST
PA-Panama	EST
PE-Lima	PES
PL-Warsaw	CET
PR-Puerto Rico	AST
PT-Lisbon	WET
PT-Madeira	WET
PT-Azores	AZO
PY-Asuncion	PYS
RO-Bucharest	EET
RU-Kaliningrad	EET
RU-Moscow	MSK
RU-Samara	SAM
RU-Yekaterinburg	YEK
RU-Omsk	OMS
RU-Novosibirsk	NOV
RU-Krasnoyarsk	KRA
RU-Irkutsk	IRK
RU-Yakutsk	YAK
RU-Vladivostok	VLA
RU-Sakhalin	SAK
RU-Magadan	MAG
RU-Kamchatka	PET
RU-Anadyr	ANA

Time Zone Name	Time Zone Code
SE-Stockholm	CET
SG-Singapore	SGT
SI-Ljubljana	CET
SK-Bratislava	CET
SM-San Marino	CET
SR-Paramaribo	SRT
SV-El Salvador	CST
TR-Istanbul	EET
TT-Port of Spain	AST
TW-Taipei	CST
UA-Kiev	EET
US-Eastern	EST
US-Central	CST
US-Mountain	MST
US-Pacific	PST
US-Alaska	AKS
US-Aleutian	HAS
US-Hawaii	HST
UY-Montevideo	UYS
VA-Vatican	CET
YU-Belgrade	CET

Index

Numerics

6753i

- customizing 13, 25
- feature 1
- getting started 3
- idle screens 6
- incomplete configuration message 7
- installation and setup 2
- no service message 7
- plugging in the phone 3
- requirements 2

A

Aastra Web UI

- Basic Settings parameters 19
- Operaton parameters 18
- phone status 18

about this guide 1

account configuration 143

account status 23

ACD key 71

allow barge-in, for intercom 186

audio, setting 29

auto-answer, for intercom 186

autodial (hotline and warmline) 194

B

BLF key 65

BLF list 67, 70

BLF List key 67

BLF/Xfer 89

BLF/Xfer key 89

BLF/Xfer, softkeys for 90, 92, 94

C

call destination, displaying 202

Call Forward key 87

call forwarding, softkeys for 87

call hold reminder 174

call hold reminder during active calls 172

call waiting tone period 169

callers list 137

downloading to phone 142

Callers List key 97

callers list key 97

callers list key, customizable 194

calls, ending 126

calls, handling 117

calls, making 112

calls, managing 127

calls, placing on hold 117

calls, receiving 116

calls, transferring 118

conference calls 121

Conference key 100

conference key, setting 99, 101

conferencing

ending 126

transfer remaining parties 126

conferencing, centralized 195

contrast level 28

D

DCP key 75

delete key 11

dial plan, emergency 47

dial tones, stuttered 170

dialing a number 112

dialpad, live 28

Directory key 95

directory key 96

Directory List

downloading to phone 136

directory list 127

downloading to PC 136

sorting 128

diverting calls 201

DND key 64

DND, enabling/disabling 143, 148

documentation 1

DTMF, suppressing playback 166

Index

Index

E

- emergency dial plan, defining 47
- empty key 110
- expansion module, 560M 205
- expansion module, M670i 205

F

- Flash key 70

G

- GCP key 75
- Goodbye key cancels incoming call 182
 - configuring 182
 - using 183
- group RTP paging 188

H

- headset mode 29
- headset, using 113
- headset/speaker mode 29
- hold, feature enhancement using 199

I

- idle screens 6
- ignore sofkey 195
- incoming call interrupts dialing 177
- incomplete configuration 7
- Indication of transferred calls 120
- installation and setup, 9122i 2
- intercom calls
 - incoming call features 184
- Intercom key 102
- intercom, outgoing calls using 193
- Introduction 212
- IP address of the phone 21
- IP address, finding 21

K

- key panel 9
- key redirection 197
- Keypad Keys 12
- keys

- ACD key 71
- Answer softkey for XML 195
- BLF key 65
- BLF List key 67
- BLF/Xfer key 89
- Call Forward key 87
- Callers List key 97
- Conference key 100
- DCP and GCP keys 75
- deleting 111
- descriptions of 8
- Directory key 95
- DND key 64
- Flash key 70
- Ignore key for XML 195
- Intercom key 102
- Last Call Return key 86
- Line key 53
- None key 110
- Paging key 108
- Park and Pickup keys 84
- Phone Lock key 106
- Services key 104
- Speeddial key 54
- Speeddial/Conf key 93
- Speeddial/Xfer key 91
- Sprecode key 82
- Transfer key 99
- XML key 79

L

- language
 - latin 2 character set 42
 - overview 34
 - specifying on IP phone 34
- last call return key 86
- LCR key 86
- Line key 53
- lines settings 49
- lock/unlock the phone 210
- locking/unlocking the phone 46

M

- M670i 205

Index

- message waiting indicator, configuring 183
- microphone mute, for intercom 185
- microphone volume, headset 29
- missed call summary subscription 193
- missed calls indicator
 - accessing and clearing 163
 - overview 163

N

- no service 7, 208
- None key 110

O

- options
 - Aastra Web UI 16
 - IP Phone UI 13
 - simplified menu 14

P

- Paging key 108
- paging, softkeys for 108
- Park key 84
- park/pickup
 - using on the IP phone 85
- password, resetting user's 44
- Phone Lock key 106
- phone status 43
- phone status, displaying 20
- playing a WAV file 196
- preferred line 180
- preferred line timeout 180
- programmable key
 - description 50

R

- redial 114
- restarting the phone 45
- ring tone sets 26
- ring tones 25
- RTP paging, group 188

S

- save key 11
- Services key 104
- speaker mode 29
- speaker/headset mode 29
- speakerphone, using 112
- speeddial
 - configuring key for 54
 - configuring prefix for 54
 - creating from Keypad Speeddial in Web UI 59
 - creating from phone keypad 55
 - creating from programmable key in Web UI 58
 - creating from SAVE key 57
 - creating from Speeddial Edit Option 56
 - editing 60
 - saving to Redial List, Callers List, Directory List 59
- speeddial/Xfer 91
- Speeddial/Xfer key 91
- Sprecode key 82
- star codes 165
- starting up the phone 3
- status scroll delay 176
- switch UI focus to ringing line 179

T

- Transfer key 99
- transferr calls
 - indication of 120
- troubleshooting solutions 207
 - changing password 208
 - display blank 207
 - finding IP address 207
 - handset not working 207
 - locking/unlocking phone 210
 - no dial tone 207
 - no light for VM message 207
 - no ring 207
 - no speakerphone 207
 - phone displays "Bad Encrypted Config"? 209
 - phone displays "No Service" 208
 - restarting phone 209

Index

Index

U

user password 43

V

voicemail 116, 164

W

warning tone, for Intercom 186

warranty, limited 212

X

XML application title 79

XML application URI 79

XML beep support 171

XML features 196, 198

XML key 79

XML service, accessing 81



A_ASTRA