



55i IP Phone

Installation Guide

41-001158-00

Rev 01

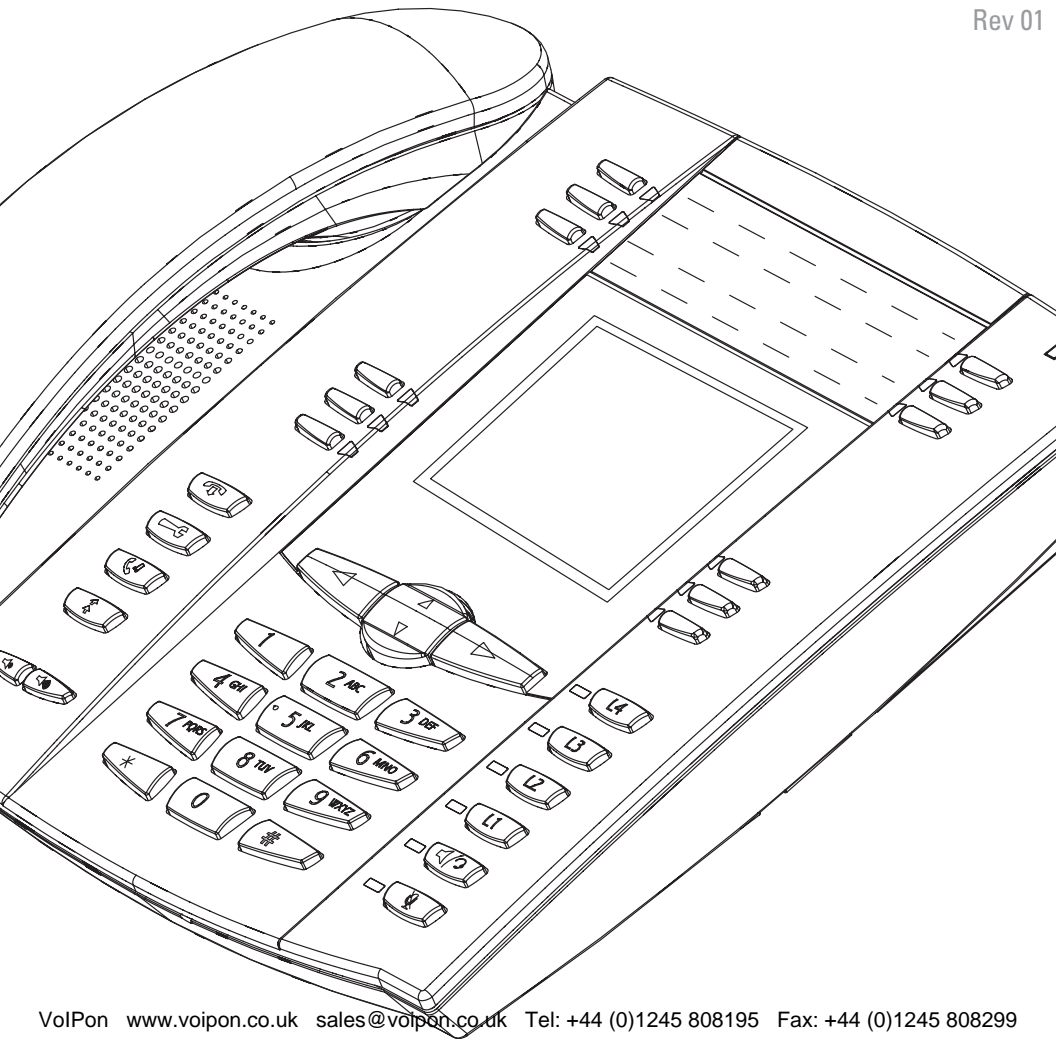

Software License Agreement

Aastra Telecom Inc., hereinafter known as "Seller", grants to Customer a personal, worldwide, non-transferable, non-sublicenseable and non-exclusive, restricted use license to use Software in object form solely with the Equipment for which the Software was intended. This Product may integrate programs, licensed to Aastra by third party Suppliers, for distribution under the terms of this agreement. These programs are confidential and proprietary, and are protected as such by copyright law as unpublished works and by international treaties to the fullest extent under the applicable law of the jurisdiction of the Customer. In addition, these confidential and proprietary programs are works conforming to the requirements of Section 401 of title 17 of the United States Code. Customer shall not disclose to any third party such confidential and proprietary programs and information and shall not export licensed Software to any country except in accordance with United States Export laws and restrictions.

Customer agrees to not reverse engineer, decompile, disassemble or display Software furnished in object code form. Customer shall not modify, copy, reproduce, distribute, transcribe, translate or reduce to electronic medium or machine readable form or language, derive source code without the express written consent of the Seller and its Suppliers, or disseminate or otherwise disclose the Software to third parties. All Software furnished hereunder (whether or not part of firmware), including all copies thereof, are and shall remain the property of Seller and its Suppliers and are subject to the terms and conditions of this agreement. All rights reserved.

Customer's use of this software shall be deemed to reflect Customer's agreement to abide by the terms and conditions contained herein. Removal or modification of trademarks, copyright notices, logos, etc., or the use of Software on any Equipment other than that for which it is intended, or any other material breach of this Agreement, shall automatically terminate this license. If this Agreement is terminated for breach, Customer shall immediately discontinue use and destroy or return to Seller all licensed software and other confidential or proprietary information of Seller. In no event shall Seller or its suppliers or licensors be liable for any damages whatsoever (including without limitation, damages for loss of business profits, business interruption, loss of business information, other pecuniary loss, or consequential damages) arising out of the use of or inability to use the software, even if Seller has been advised of the possibility of such damages.

Table of Contents

Software License Agreement	iii
Introduction	1
Phone Features	1
Requirements	1
About This Guide	2
Phone Parts	3
Optional Accessories (Not Included)	3
Key Panel	5
Key Description.....	6
Installation and Setup	8
Direct or Shared Network Connection	8
Connecting to the Network and to Power	10
Connecting a Handset or Headset	12
Desk or Wall Installation	13
Inserting the Key Card on your Phone	15
Customizing your phone	16
Accessing Your Options via the Phone UI	16
Accessing Your Options via the Aastra Web UI	17
Other Phone Features	22
Adjusting the Volume	22
Status Lights (LEDs)	22
Call Timer	23
Softkeys	23
Programmable Keys	23
Line/Call Appearance Keys	24
Using a Headset with your Telephone	24
Model 536 Expansion Modules (536EM)	25
Installing the 536EM	26
Troubleshooting Solutions	28
Limited Warranty	31

Introduction

Congratulations on your purchase of the Model 55i IP Phone! The 55i communicates over an IP Network, allowing you to place and receive calls in the same manner as a regular business telephone. The 55i is capable of supporting the SIP IP protocol.

Phone Features

- 8 line graphical LCD screen (144 x 75 pixels) with white backlight
- 12 programmable keys
 - 6 Top keys: Programmable hard keys (up to 6 programmable functions)
 - 6 Bottom keys: Programmable state-based softkeys (up to 20 programmable functions)
- 4 call appearance lines with LEDs
- Supports up to 9 call lines
- Full-duplex speakerphone for handsfree calls
- Headset support (modular connector)
- Built-in-two-port, 10/100 Ethernet switch - lets you share a connection with your computer.
- Inline power support (based on 802.3af standard) which eliminates power adapters.
- AC power adapter (included)
- Enhanced busy lamp fields*
- Set paging*

* Availability of feature dependant on your phone system or service provider

Requirements

The 55i IP Phone requires the following environment:

- SIP-based IP PBX system or network installed and running with a SIP account created for the 55i phone.
- Access to a Trivial File Transfer Protocol (TFTP), File Transfer Protocol (FTP), Hypertext Transfer Protocol (HTTP) server, or Hyper Text Transfer Protocol over Secure Sockets Layer (SSL) (HTTPS).
- 802.3af Ethernet/Fast Ethernet LAN
- Category 5/5e straight through cabling
- Power over Ethernet (PoE) inline power injector (optional accessory - necessary only if your network provides no inline power and if you do not use the IP Phone's power adapter).

About This Guide

This manual describes how to physically set up your new 55i. Not all features listed are available by default and some may depend on your phone system or service provider. Contact your system administrator if you have any questions on what features and services are available to you on your system. This guide complements the ***SIP IP phone Aastra 53i, 55i, 57i, 57i CT Administrator Guide*** and the ***Aastra Model 55i User Guide***.

SIP IP Phone Aastra 53i, 55i, 57i, 57i CT Administrator Guide – is designed for network administrators, system administrators, developers and partners who need information on installing this product on an IP network.

Aastra Model 55i IP Phone User Guide – explains the most commonly used IP telephone features for an end user.

Phone Parts

When you unpack your phone, you should ensure that you have all of the following items. If any part is missing, contact the supplier of your phone.

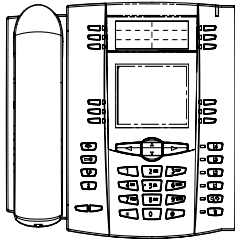

Telephone



Handset



Handset Cord



Programmable Key Card

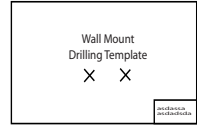

Wall Mount Drilling Template



Telephone Base Desk Legs



Power Adapter



Ethernet Cable



55i Installation Guide



Screws and Anchors for Wall Mounting

Optional Accessories (Not Included)

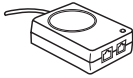

PoE (Power over Ethernet) Inline Power Injector

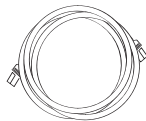

Additional Ethernet Cable (category 5/5e straight through cable)

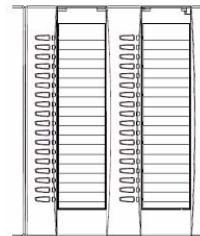

Model 536EM Expansion Module

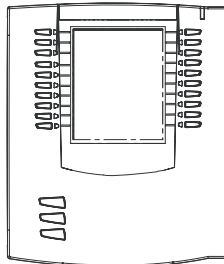

Model 560EM Expansion Module

A PoE (Power over Ethernet) inline power injector supplies 48v power to the 55i through the Ethernet Cable on pins 4 & 5 and 7 & 8.



Warning: Do not use this PoE inline power injector to power other devices.





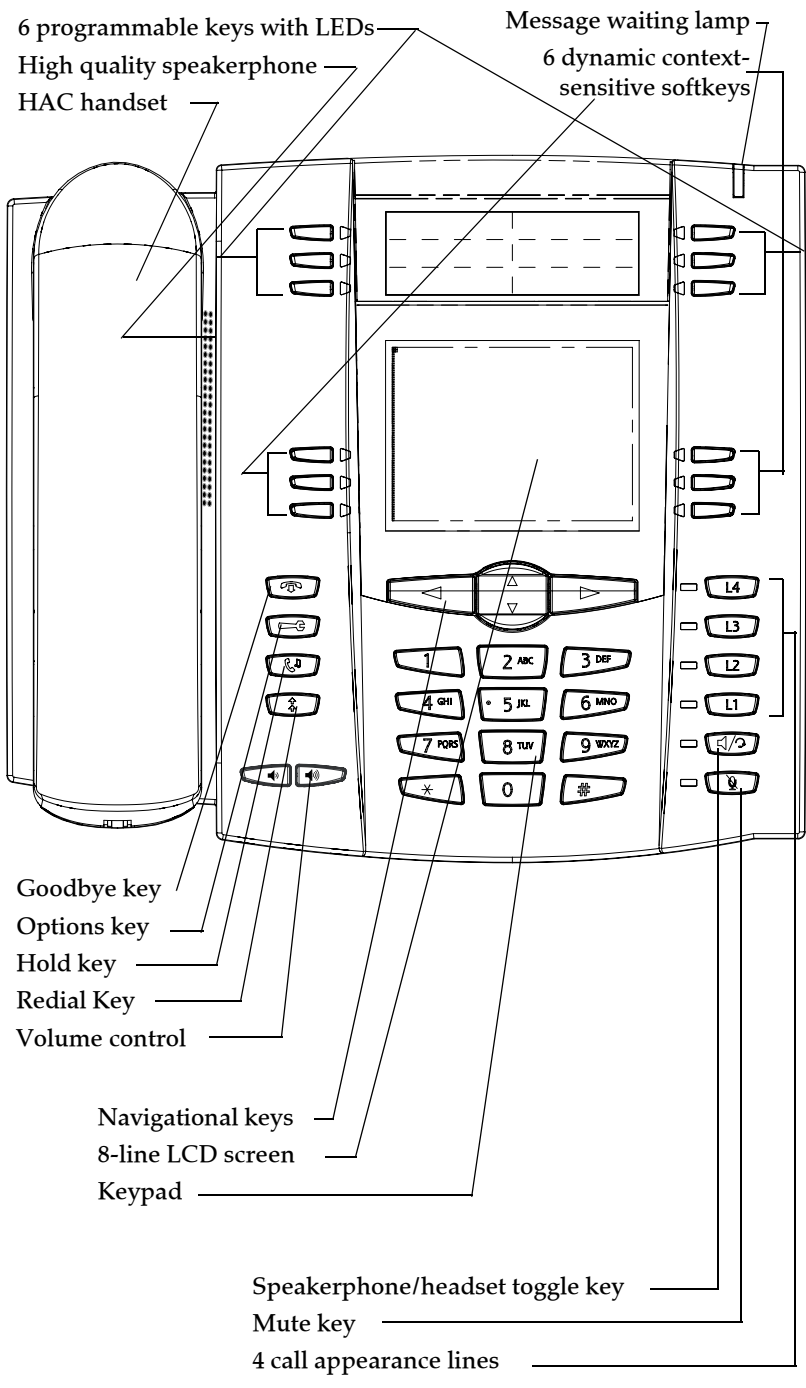





The Model 536 Expansion Module (536EM) and Model 560 Expansion Module (560EM) attach to the right side of the 55i phone. Model 536EM provides 36 additional softkeys for the phone. Model 560EM provides 60 additional softkeys. For more information about the expansion modules, see the section, [Model 536 Expansion Modules \(536EM\)](#) on page [page 25](#).



Key Panel



Key Panel

Key Description*

Keys	Key Description
	Goodbye key - Ends an active call. The Goodbye key also exits an open list, such as the Options List, without saving changes.
	Options key - Accesses options to customize your phone. Your System Administrator may have already customized some of your settings. Check with your System Administrator before changing the administrator-only options.
	Hold key - Places an active call on hold. To retrieve a held call, press the call appearance button beside the light that is flashing.
	Redial key - Redials up to 100 previously dialed numbers. Pressing the Redial key twice simultaneously redials the last dialed number.
	Volume control key - Adjusts the volume for the handset, headset, ringer, and handsfree speaker. See " Adjusting the Volume " on page 22 for more information.
   	Line/Call Appearance key - Connects you to a line or call. The Aastra 55i IP phone supports up to 4 line keys.
	Handsfree key - Activates Handsfree for making and receiving calls without lifting the handset. When the audio mode option is set, this key is used to switch between a headset and the handsfree speakerphone. See " Customizing your phone " on page 16 for more information.
	Mute key - Mutes the microphone so that your caller cannot hear you (the light indicator flashes when the microphone is on mute).

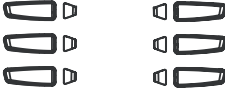
Keys	Key Description												
	<p>Navigation keys - Pressing the UP and DOWN arrow keys lets you view different status and text messages on the LCD display (if there is more than 1 line of status/text messages). These buttons also let you scroll through menu selections, such as the Options List.</p> <p>Pressing the LEFT and RIGHT arrow keys lets you view the different line/call appearances. While in the Options List, these keys allow you to exit or enter the current option. When you are editing entries on the display, pressing the LEFT arrow key erases the character on the left; pressing the RIGHT arrow key sets the option.</p>												
	<p>Programmable keys - 6 Top keys: programmable hard keys (up to 6 programmable functions)</p> <p>By default, keys 1 through 4 are assigned as Services, Directory, Callers List, and Intercom, respectively. Keys 5 and 6 have no assigned functions. All 6 keys are programmable and can be assigned to perform specific functions.</p> <p>The following are the default functions for the programmable keys on the 55i IP phone:</p> <table border="0"> <tr> <td>1 - SERVICES</td> <td>Accesses enhanced features and services such as XML applications and voicemail, provided by third parties.</td> </tr> <tr> <td>2 - DIRECTORY</td> <td>Displays up to 200 names and phone numbers (stored in alphabetical order)</td> </tr> <tr> <td>3 - CALLERS LIST</td> <td>Accesses the last 200 calls received.</td> </tr> <tr> <td>4 - INTERCOM</td> <td>Accesses another extension on the network.</td> </tr> <tr> <td>5 - NONE</td> <td>No assigned function</td> </tr> <tr> <td>6 - NONE</td> <td>No assigned function</td> </tr> </table> <p>Note: For more information about programming keys 1 through 6 to perform specific functions, see the <i>Aastra Model 55i User Guide</i>.</p>	1 - SERVICES	Accesses enhanced features and services such as XML applications and voicemail, provided by third parties.	2 - DIRECTORY	Displays up to 200 names and phone numbers (stored in alphabetical order)	3 - CALLERS LIST	Accesses the last 200 calls received.	4 - INTERCOM	Accesses another extension on the network.	5 - NONE	No assigned function	6 - NONE	No assigned function
1 - SERVICES	Accesses enhanced features and services such as XML applications and voicemail, provided by third parties.												
2 - DIRECTORY	Displays up to 200 names and phone numbers (stored in alphabetical order)												
3 - CALLERS LIST	Accesses the last 200 calls received.												
4 - INTERCOM	Accesses another extension on the network.												
5 - NONE	No assigned function												
6 - NONE	No assigned function												
	<p>Softkeys - 6 Bottom keys: programmable state-based softkeys (up to 20 programmable functions)</p> <p>Note: For more information about programming keys 1 through 6 to perform specific functions, see the <i>Aastra Model 55i User Guide</i>.</p>												

*See the Aastra 55i User Guide for more information about each of these keys.

Installation and Setup

The 55i can be setup to share a network connection with another network device. Power can be provided by the power adapter (optional accessory), or by an 802.3af compliant network power source, or with a PoE inline power injector (optional accessory). It can also be installed on a desk or mounted on the wall. If your System Administrator has already setup your phone, please refer to the **55i User Guide** for call handling information or contact to your System Administrator.

Direct or Shared Network Connection

The phone can be set up as a direct network connection to the Ethernet wall jack or as a shared network connection as a pass-through if connecting a computer or another network device.

Direct Network Connection

Located at the top of the phone are two fully switched 10/100 Mbps Ethernet cable ports. The port marked with **LAN** is used to connect the phone to the network, as well as provide power to your phone (if required). See the section "[Connecting to the Network and to Power](#)" on [page 10](#) for more information.

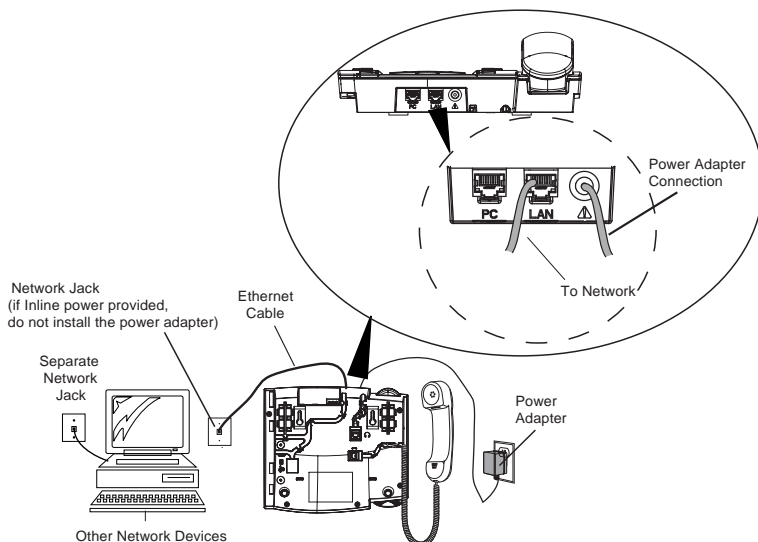

Shared Network Connection

To connect a network device (such as a computer) to the phone, connect an Ethernet cable into the network port on the top of the phone marked with **PC**. Plug the other end of the Ethernet cable into the network jack on the network device for which you are sharing the network connection.

Note: The **PC** jack on the 55i does not supply inline power onto other network devices. All Ethernet cables used must be minimum category 5/5e straight-through cables, such as the cable provided with your phone.

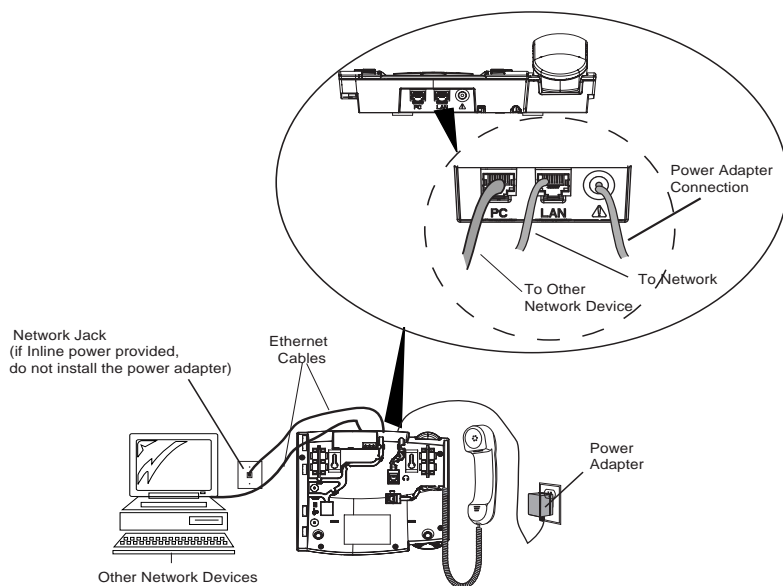

Connecting to the Network and to Power

Inline Power Provided

If your network provides 802.3af compliant in-line power, the phone is powered through the network.

1. On the top of your phone, connect the Ethernet cable (provided with your phone) into the network port marked with **LAN**.
2. Plug the other end of the Ethernet cable directly into the network jack on the wall.

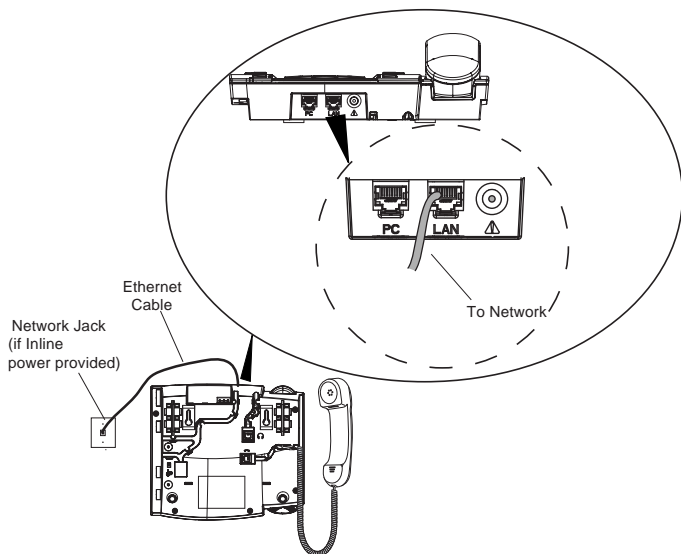

Inline Power Not Provided

If your network does not provide 802.3af compliant in-line power, you need to install the PoE inline power injector (optional accessory).

1. On the top of your phone, connect the Ethernet cable (provided with your phone) into the network port marked with **LAN**.
2. On the PoE power injector, plug the other end of the Ethernet cable into the network jack marked as indicated in the illustration below.
3. On the PoE power supply, connect an additional Ethernet cable into the network port as indicated in the illustration below.
4. Plug the other end of the Ethernet Cable into the network jack on the wall.
5. Plug the PoE power injector into a power outlet.

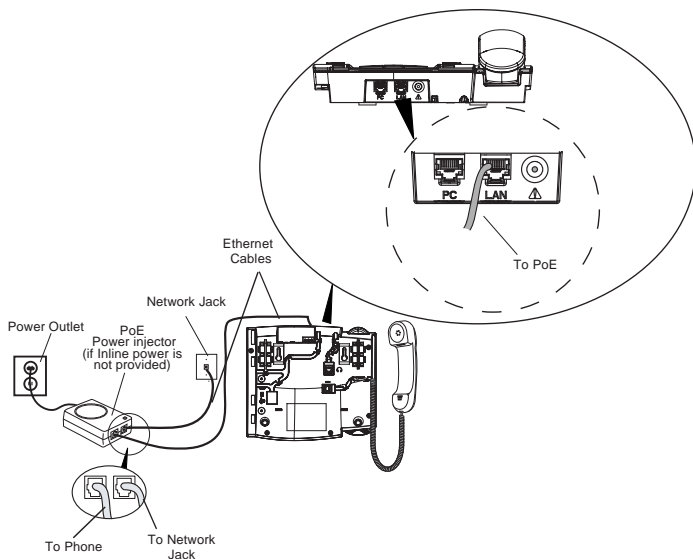

Note: You should connect the power supply to a surge protector or power bar. All Ethernet cables used must be minimum category 5/5e straight-through cables, such as the cable provided with your phone.

Connecting a Handset or Headset

Handset

Turn the phone over and locate the handset jack marked . Insert one end of handset cord into the jack until it clicks into place. Then route the handset cord through the groove as shown in the illustration below. Attach the handset to the other end of the handset cord.

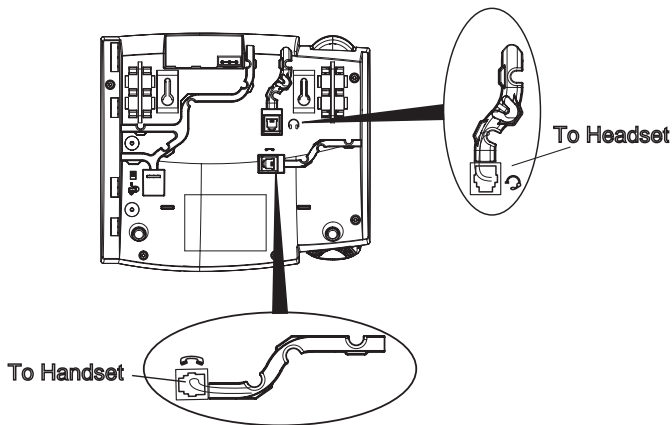

Headset (Optional)

Turn the phone over and locate the headset jack marked . Insert the headset cord into the jack until it clicks into place. Then route the headset cord through the groove as shown in the above illustration.

Desk or Wall Installation

Install on the Desk

The desk installation for the 55i IP phone consists of two legs that attach to the back of the phone near the top corners. A total of four different viewing angles allows users to personalize their phone viewing preference.

Attach each leg by inserting the tabs on the leg into the slots on the bottom of the phone. There are three pair of leg slots on each corner of the phone; each leg uses two pairs (1&2, or 2&3) giving two leg positions designating different viewing angles. Furthermore, the legs can be reversed which offer two additional viewing angles.

For a higher viewing angle, use the second and third slots from the top. For a lower viewing angle, use the first and second slots from the top. Then push the stand towards the phone until it snaps into place.

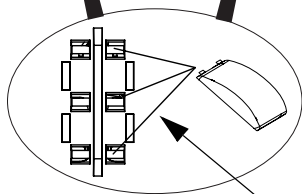
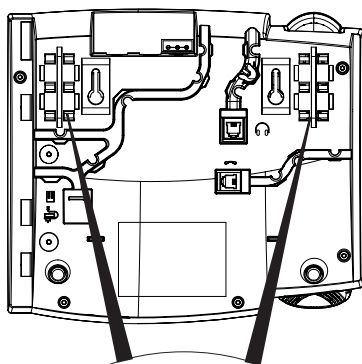

Three stand slot locations for customizing the height of the desk phone.

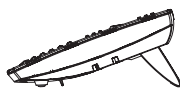

20.7 deg.
Incline Angle

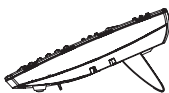

23.3 deg.
Incline Angle

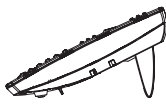

26.6 deg.
Incline Angle

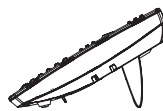

30.9 deg.
Incline Angle

Total 4 Viewing Angles

Install on the Wall

The 55i IP phone has two pre-drilled wall mounting holes on the back of the phone. Using the provided wall mount drilling template, locate and mark the position for the mounting screws on the wall. Depending on the wall type, you may need to use wall anchors. Both the screws and wall anchors are included with your phone.

Place the wall mount holes on the phone over the screw heads on the wall and pull down to lock the phone in.

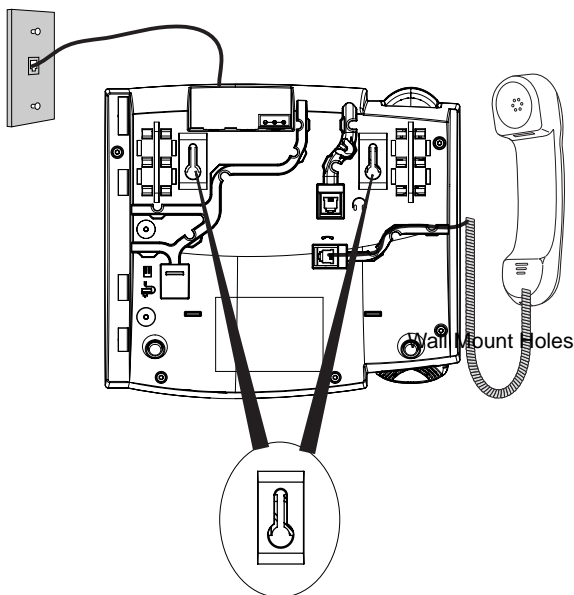

Note: You may wish to purchase a short Ethernet cable from a local supplier for a wall installation. Also, if 802.3af compliant in-line power is not provided on your network, and you are installing the 55i on a wall using a PoE in-line power injector, you may also wish to use an equivalent flat Ethernet cable rather than the one provided.

Inserting the Key Card on your Phone

This card contains the label identification spaces for 6 programmable keys.

1. Remove the clear plastic lens from the top front panel of the telephone by gently pressing down on the lens and sliding upward.
2. Place the card into the programmable key card slot on the top front panel of the telephone using the indentation of the plastic for alignment.
3. With one hand holding the label card in place, gently slide the clear plastic lens into the slots at the top of the programmable key panel.

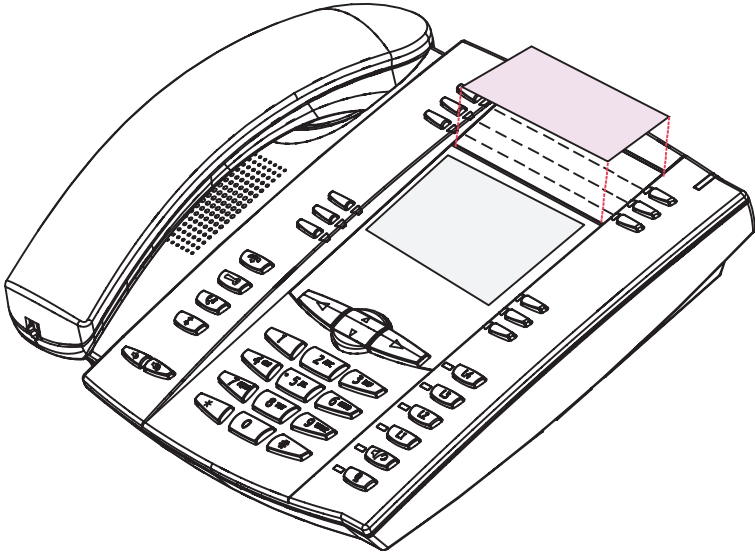



Customizing your phone

There is a list of configuration options, accessed by pressing the  button on the phone. You can access some of these options via the Aastra Web UI also. The following table indicates the options and the method you can use to access these options on your phone.

Phone Option	Access from Phone UI	Access from Aastra Web UI
Language	✓	✓
Time and Date		
Time	✓	
Date	✓	
Time and Date Formats	✓	
Time Server	✓	✓
Time Zone	✓	
Daylight Savings Time	✓	
Ring Tones/Tone Sets	✓	✓
Clear Message Waiting	✓	
Contrast Level	✓	
Backlight	✓	
Live Dialpad	✓	
Set Audio		
Audio Mode	✓	
Headset Mic Volume	✓	
Call Forward		
Number	✓	✓
Mode	✓	✓
No. of Rings	✓	✓
Phone Status		
Network Status	✓	✓
Firmware Version	✓	✓
Restart Phone	✓	✓
User Password	✓	✓
Phone Lock	✓	✓

Accessing Your Options via the Phone UI

1. Press the Options key  on the phone to enter the options list.
2. To go to an **Option**, use Δ and ∇ to scroll through the list, or press the number corresponding to the **Option**.
3. Press the Show softkey, the \triangleright button, or press the digit number of the corresponding option to select an option.
4. Use the softkeys to change a selected option.
5. Press the Done softkey at any time to exit the option and save the change.
6. Press the Cancel softkey, the \triangleleft button, or the  button at any time to exit without saving changes.

Accessing Your Options via the Aastra Web UI

You can use the following procedure to access the phone options using the Aastra Web UI.



Aastra Web UI

1. Open your web browser and enter the phone's IP address or host name into the address field.

If the browser is using HTTP, the following redirect screen displays, followed by the "Security Alert" window. This process redirects HTTP to use HTTPS for a more secure connection..

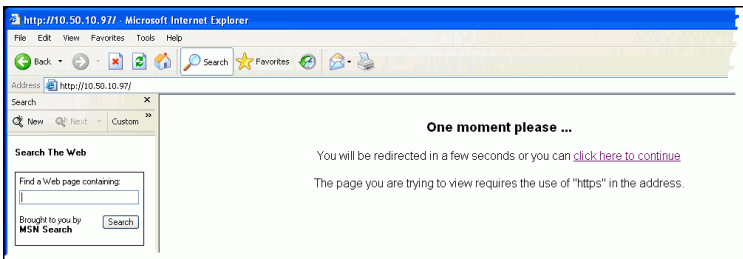

2. Click **YES** to accept the certificate
3. At the prompt, enter your username and password and click .
The Network Status window displays for the IP phone you are accessing.

Note: For a user, the default user name is "user" and the password field is left blank.

The Network Status window displays for the IP phone you are accessing.

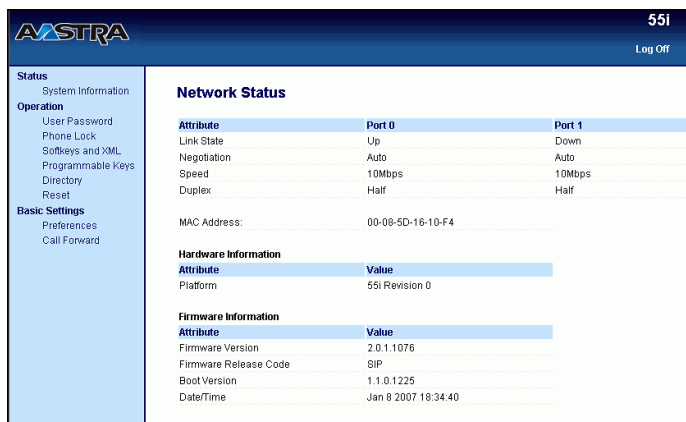

4. You can logout of the Aastra Web UI at any time by clicking **Log Off**.

The following categories display in the side menu of the Aastra Web UI: **Status, Operation, Basic Settings**.

Reference

For more information about changing your options using the Aastra Web UI, see the ***Aastra Model 55i IP Phone User Guide***.

Language

Select a language that you would like your phone to use for displaying prompts and menus.

Note: Supported languages may vary depending on configuration. Contact your Network Administrator for list of available languages.

Time and Date

Use these options to set the local time on the phone. Depending upon the configuration, time set here may be overwritten by the time on your phone system. If you are having problems with this, contact your Network Administrator.

- **Time Server**

Talk to your Network Administrator before making changes to this option.

If the Time Server option is enabled, the display shows the IP address where the phone is getting time and date information from on the Network. Whenever the phone starts up, it will automatically attempt to find the Time Server. If the Time Server is not found and unknown to the phone, the IP address will display as 0.0.0.0, and the time and date in the main screen displays the equivalent of "12:00 am Jan. 1st 2000". If the Time Server option is disabled, the display shows "Network Time Disabled". You can set the time and date manually on your phone.

- **Set Time**

This option shows the Network time, if the Time Server option is enabled. It also allows you to set the time manually.

Note: if you set the time manually, the phone will not try to synchronize the time with a timeserver until the next time it is restarted.

- **Time Format**

Select a time format for how time displays on your phone (12h or 24h clock).

- **Set Date**

This option shows the Network date, if the Timeserver option is enabled. It also allows you to enter the date manually.

Note: if you set the date manually, the phone will not synchronize the date with a timeserver until the next time it is restarted.

- **Date Format**

Choose from a list of formats for how the date displays on your phone.

- **Time Zone**

Choose your current time zone. Select your country by scrolling through a list, or by entering the country code (i.e., CA, US), then pick from the time zone list for that country.

- **Daylight Savings**

This option allows you to specify daylight savings.

Set Ring Tone/Tone Set

Use these options to set the preference of ring tone and call progress tones for your phone.

- **Ring Tone**

Press the **Change** softkey to select one of the five ring tones or silent. Use the volume bar to increase or decrease the ringer volume level.

- **Tone Set**

Press the **Change** softkey to select one of the seven predefined tone sets for the phone to play country specific call progress tones such as dial tone, ringing tone, busy tone, congestion tone, call waiting tone, and ringing cadence.

Clear Message Waiting

To clear the Message Waiting Light, select the **Clear** softkey. The light will flash again when there are new messages waiting.

Contrast Level

Use these options to set the preference of contrast level and backlight for your phone.

- **Contrast Level**

Use the **Change** softkey to cycle through eight contrast settings, which brighten or darken the display.

- **Backlight**

Use the **Change** softkey to cycle through different backlighting options of OFF, ON, or Auto. Auto backlighting sets the phone to turn off the backlighting after a period of inactivity; the idle period is user definable under the **Advanced** softkey when you select the Auto option. The backlight is turned on with a key press or state change on the phone.





Live Dialpad*

This option turns the Live Dial Pad mode ON or OFF. With live dial pad ON, the 55i IP phone automatically dials out and turns ON Handsfree mode as soon as a dial pad key or softkey is pressed. With live dial pad OFF, if you dial a number while the phone is on-hook, lifting the receiver or pressing the  initiates a call to that number. Press the **Change** softkey to turn ON or OFF the dial pad mode.

*Availability of feature dependant on your phone system or service provider.

Set Audio

The 55i allows you to use a handset, a headset, or handsfree to handle incoming and outgoing calls. The audio mode option provides different combinations of these three methods to provide maximum flexibility in handling calls. There are four audio mode options to choose from:

Audio Mode Option	Description
Speaker	This is the default setting. Calls can be made or received using the handset or handsfree speakerphone. In handset audio mode, pressing the  button on the phone switches to handsfree speakerphone. In Speaker audio mode, lift the handset to switch to the handset.
Headset	Choose this setting if you want to make or receive all calls using a handset or headset. Calls can be switched from the handset to headset by pressing the  button on the phone. To switch from the headset to the handset, lift the handset.
Speaker/Headset	Incoming calls are sent to the handsfree speakerphone first when the  button is pressed. By pressing the button again, you can switch back and forth between the handsfree speakerphone and the headset. At anytime, lifting the handset switches back to the handset from either the handsfree speakerphone or the headset.
Headset/Speaker	Incoming calls are sent to the headset first when the  button is pressed. By pressing the button again, you can switch back and forth between the headset and the handsfree speakerphone. At anytime, lifting the handset switches back to the handset from either the headset or the handsfree speakerphone.

Headset Mic Volume

To adjust the headset microphone volume, press **Advanced** after selecting the audio option, and then select the **Low**, **Medium**, or **High** volume level.

Call Forward

Use this option to call forward your phone. Use the Δ and ∇ buttons to move between the fields to set the call forward **Number**, **Mode**, and **No. Rings**. The selectable call forward mode includes: All, Busy, NoAns (No Answer), BusyNoAns (Busy No Answer), or Off; this is selected via the \triangleleft and \triangleright buttons.

Network

This is a system administrator level-only option, and requires a password to access. See the **SIP IP phone Aastra 53i, 55i, 57i, 57i CT Administrator Guide** for details.

SIP Settings

This is a system administrator level-only option, and requires a password to access. See the **SIP IP phone Aastra 53i, 55i, 57i, 57i CT Administrator Guide** for details.

Phone Status

This option allows you to:

- View your network status including your phone's IP and MAC address
- View your firmware version
- Restart your phone

There is also a system administrator level-only option to reset the phone to factory default settings. See your system administrator for details.



User Password

Use this option to change your user password. Valid values for entering a password are 0 to 4294967295 (integers only; symbols and alpha characters are not allowed). Default password is an empty string "" (field is blank).

Phone Lock

Use this option to lock the phone from unauthorized users. When the phone is locked, users are unable to dial from the phone unless it has been unlocked. To unlock the phone, press the  button and enter either the user or administrator password.







Note: While the phone is locked, only emergency number dialing is permitted. The default permissible emergency numbers are 911, 999, 112, and 110; this is configurable via the WebUI or configuration file.

Hint: To quickly lock your phone, press the  button followed by the  key.

Other Phone Features

Adjusting the Volume

Pressing the volume button  adjusts the receiver, headset, speaker, and ringer volume.

- To adjust the ringer volume, leave the handset in the cradle and press the volume button  while there is no active call. There are 10 settings for the ringer including Off — the display will temporarily indicate the current ringer volume setting.
- To adjust the handset volume, lift the handset and press the volume button  while the handset is off hook. The handset will remain at this volume until it is adjusted again.
- To adjust the headset volume, press the volume button  while the headset is activated (activate the headset by pressing ; ensure headset audio mode is set). The headset will remain at this volume until it is adjusted again.
- To adjust the speaker volume, press the volume button  while the speaker is activated (activate the speaker by pressing ; ensure handsfree speakerphone audio mode is set). The speaker will remain at this volume until it is adjusted again.

Status Lights (LEDs)

The speaker LED, beside the  key, and the Message Waiting Indicator (MWI) LED, on the top right of your phone, provide visual indications of your phone's status.

Speaker LED

Speaker LED Status	Description
ON solid	Indicates a call is on Handsfree (speakerphone)
Slow Flash	Indicates you are using the headset.
Rapid Flash	Indicates the call is muted. Press  to take the call off mute.

Message Waiting Indicator (MWI)

MWI LED Status	Description
Slow Flash	Indicates you have a message(s).
Rapid Flash	Indicates you have an incoming call.
Even Flash	Indicates one or more calls are on hold.

Call Timer

- When you make or answer a call, the Timer shows the elapsed time of the call.

Softkeys

On the 55i IP Phone, there are 6 bottom, state-based softkeys that are programmable up to 20 functions. These keys are located at the center of the phone on either side of the display panel. These softkeys make call handling and call managing easier.

You can also set the softkey to display a specific state on the IP phone UI. You must use the Aastra Web UI to configure the softkey.

For more information about softkeys on the 55i IP phone, see the ***Aastra Model 55i IP Phone User Guide***.

Programmable Keys

On the 55i IP Phone, there are 6 top hard keys (programmable up to 6 functions), located at the top of the front panel. These are keys that you can set to perform specific functions and access enhanced services provided by third parties (for example, XML applications). Other services include accessing Directory and Call Logs.

By default, keys 1 through 4 are assigned as Services, Directory, Callers List, and Intercom, respectively. Keys 5 and 6 have no assigned functions. All 6 keys are programmable and can be assigned to perform specific functions.

Note: Availability of the services feature is dependant on your phone system and/or service provider.

These keys can also be set up to quickly access features such as Call return (*69) or Voicemail.

Note: Quick access features like Call return and Voicemail must first be configured on your PBX in order to work on your phone. See your system administrator for more information.

For more information about programmable keys on the 55i IP phone, see the ***Aastra Model 55i IP Phone User Guide***, or contact your System Administrator.

Line/Call Appearance Keys

The 55i has 4 hard line/call appearance keys each with a corresponding status light. Additional line/call appearances may also be set up on your phone as softkeys.

These line/call appearance buttons and lights represent physical lines or calls for your extension. By pressing a line/call appearance button, you connect to the line or a call it represents. The line/call appearance light indicates the status of that line or call.

When the phone is taken off-hook, the phone will automatically select a line for you.

Line/Call Appearance LED Status	Description
OFF	Indicates idle line or no call activity
Rapid Flash	Indicates ringing on the line.
Slow Flash	Indicates a call is on hold.



For more information about the Line/Call Appearance keys, see the *Aastra Model 55i IP Phone User Guide*.

Using a Headset with your Telephone

The 55i accepts headsets through the modular jack on the back of the phone. Contact your telephone equipment retailer or distributor to purchase a compatible headset. A non-amplified headset is required. Customers should read and observe all safety recommendations contained in headset operating guides when using any headset.

Note: For best headset performance, Aastra recommends non-amplified headset equipped with modular connector.

Making and Receiving Calls using a Headset

1. Ensure that you have selected a headset audio mode by accessing the Options menu. See the section "[Customizing your phone](#)" on [page 16](#) for detailed information.
2. Plug the headset into jack.
3. Press the  key to obtain dial tone or answer an incoming call. Depending on the audio mode selected from the Options menu, dial tone or an incoming call will be received on either the headset or the handsfree speakerphone.
4. Press the  key to end the call.

Model 536 Expansion Modules (536EM)

The 55i IP Phone offers optional Expansion Modules that attach to the right side of the phone to provide additional softkeys.

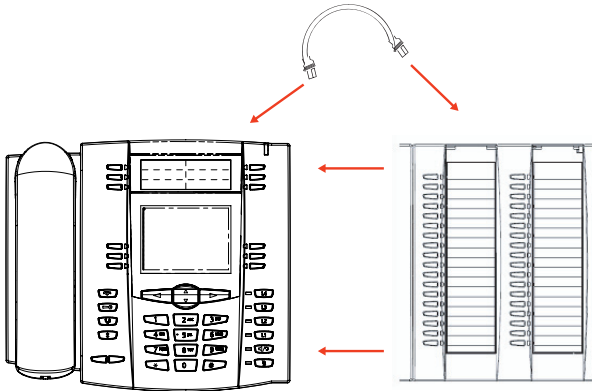

The 536EM provides 36 additional softkeys on a 55i IP Phone. The softkeys support the following features:

- BLF
- Speedial
- Shared Call Appearance

Each key provides an LED for indicating call status. The 536EM provides a paper label for convenient key labeling.

Additional 536EM modules (up to 3 total modules) can be piggy-backed to an existing module providing an additional 108 softkeys to the phone. You connect the additional modules to the right side of an existing module. The following figure illustrates the addition of multiple 536EM modules on the 55i IP Phone.

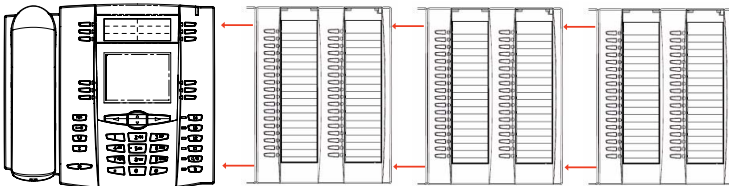

You can configure the softkeys via the configuration files or the Aastra Web UI. See the *Aastra 55i SIP IP Phone User Guide* for more information about using the expansion modules on the 55i IP phone.

Installing the 536EM

On the 536EM, there are 18 softkeys in each column (totaling 36 keys) on the keypad.

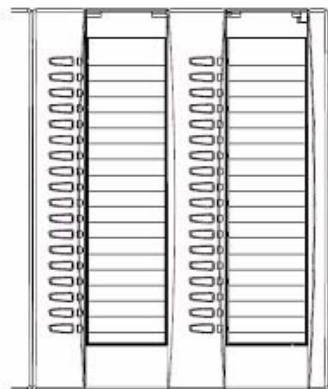

536EM

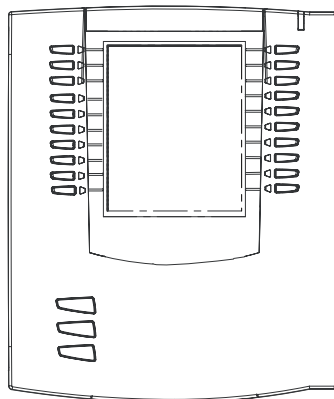

560EM

The module connects to the right side of the 55i IP phone via an RJ-45 connector.

Connecting the Expansion Modules to Your Phone

Use the following procedure to connect the 536EM to your 55i IP phone.

1. Turn your phone over to show the bottom of the phone.
2. Turn the expansion module over to show the bottom of the module.
3. Connect one end of the RJ-45 cable to the RJ-45 port on the back of your phone as indicated in the illustration below.

**Back of Expansion
Module**

Back of Phone

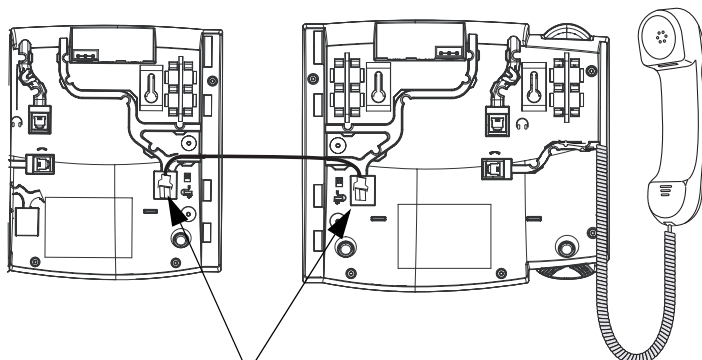

RJ-45 Connectors

4. Connect the other end of the RJ-45 cable to the RJ-45 port on the back of the expansion module as indicated in the illustration above.
5. Turn over both units to sit face up on the desk with the expansion module sitting flush against the right side of the phone.

Note: Install additional modules as applicable using additional RJ-45 cables. You must attach any additional module to the right side of an existing module (piggy-backed) as shown in the following illustration.

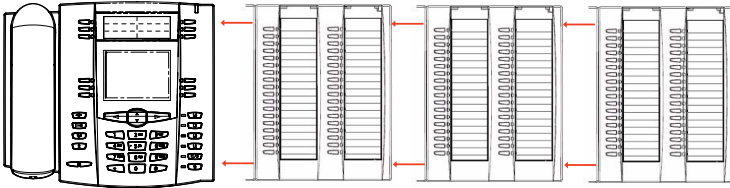

For more information about setting the softkeys, see the ***Aastra Model 55i IP Phone User Guide***.

Troubleshooting Solutions



Why is the light not coming on with a new Voice Mail Message?

Your phone system or service provider must provide "Visual" Message Waiting service for this function to work. Check with your system administrator for more information.

Why is my handset not working?

Check to ensure that the handset cord is fully connected to both the phone and handset. See the section "[Connecting a Handset or Headset](#)" on [page 12](#) for information.

Why is my speakerphone not working?

If you press  and the speaker light flashes and you do not hear dial tone, the Set Audio option has been used to set up the phone for headset use; press  a second time. If the light goes out, the phone is set up to be used only with a headset or handset. If the light stays on steady and you hear dial tone, you can alternate between the speakerphone and the headset by pressing . See the section, "[Set Audio](#)" on [page 20](#) for instructions on how to change the Set Audio feature.

Why is my display blank?

Ensure that power is being provided to your phone. If your Network does not provide Inline power over Ethernet, you can obtain an additional accessory, the a PoE inline power injector, to provide power over Ethernet locally to your phone. See the section "[Connecting to the Network and to Power](#)" on [page 10](#) for details.

Why can I only see 4 options when the installer or user guide says there are more?

The telephone screen will only show 4 options at a time. To see more, press the down arrow button .

Can I turn the backlight for the screen on and off?

Yes. You can use the IP phone UI to turn ON and OFF the backlight for the screen.

1. Press the  key.
2. Select **Display->Backlight**.
3. Press the **Change** key to turn the backlight on and off.
4. Press **Save** to save the change.

Why does the telephone wobble?

Make sure the cords are routed properly through the back of the phone, as indicated in the section, "[Connecting a Handset or Headset](#)" on [page 12](#). Check that the leg stands have been properly snapped into place. Since the legs can be oriented in two different ways and in two different positions to offer four different phone viewing angles, check that both legs are oriented in the same direction and in the same position on either side of the phone.

What is a softkey?

There are 6 bottom, state-based softkeys that are programmable up to 20 functions. These keys are located at the center of the phone on either side of the display panel. See the section "[Softkeys](#)" on [page 23](#) or refer to your **Aastra Model 55i IP Phone User Guide** for more information.

What is a programmable key?

There are 6 top hard keys (programmable up to 6 functions), located at the top of the front panel. These are keys that you can set to perform specific functions and access enhanced services provided by third parties (for example, XML applications). See the section "[Programmable Keys](#)" on [page 23](#) or refer to your **Aastra Model 55i IP Phone User Guide** for more information.

Limited Warranty

Aastra Telecom warrants this product against defects and malfunctions during a one (1) year period from the date of original purchase. If there is a defect or malfunction, Aastra Telecom shall, at its option, and as the exclusive remedy, either repair or replace the telephone set at no charge, if returned within the warranty period.

If replacement parts are used in making repairs, these parts may be refurbished, or may contain refurbished materials. If it is necessary to replace the telephone set, it may be replaced with a refurbished telephone of the same design and color. If it should become necessary to repair or replace a defective or malfunctioning telephone set under this warranty, the provisions of this warranty shall apply to the repaired or replaced telephone set until the expiration of ninety (90) days from the date of pick up, or the date of shipment to you, of the repaired or replacement set, or until the end of the original warranty period, whichever is later. Proof of the original purchase date is to be provided with all telephone sets returned for warranty repairs.

Exclusions

Aastra Telecom does not warrant its telephone sets to be compatible with the equipment of any particular telephone company. This warranty does not extend to damage to products resulting from improper installation or operation, alteration, accident, neglect, abuse, misuse, fire or natural causes such as storms or floods, after the telephone is in your possession.

Aastra Telecom shall not be liable for any incidental or consequential damages, including, but not limited to, loss, damage or expense directly or indirectly arising from the customer's use of or inability to use this telephone, either separately or in combination with other equipment. This paragraph, however, shall not apply to consequential damages for injury to the person in the case of telephones used or bought for use primarily for personal, family or household purposes.

This warranty sets forth the entire liability and obligations of Aastra Telecom with respect to breach of warranty, and the warranties set forth or limited herein are the sole warranties and are in lieu of all other warranties, expressed or implied, including warranties or fitness for particular purpose and merchantability.

Warranty Repair Services

Should the set fail during the warranty period;

In North America, please call 1-800-574-1611 for further information.

Outside North America, contact your sales representative for return instructions.

You will be responsible for shipping charges, if any. When you return this telephone for warranty service, you must present proof of purchase.

After Warranty Service

Aastra Telecom offers ongoing repair and support for this product. This service provides repair or replacement of your Aastra Telecom product, at Aastra Telecom's option, for a fixed charge. You are responsible for all shipping charges. For further information and shipping instructions;

In North America, contact our service information number: 1-800-574-1611.

Outside North America, contact your sales representative.

Note: Repairs to this product may be made only by the manufacturer and its authorized agents, or by others who are legally authorized. This restriction applies during and after the warranty period. Unauthorized repair will void the warranty.

Index

Numerics

55i line settings 24

A

audio, setting 20

B

backlight 20

C

call forward 21

call timer 23

Callers List key 7

Connecting a Handset or Headset 12

Connecting to the Network and to Power 10

contrast level, setting 19

Customizing your phone 16

D

date

 setting date 19

 setting format 19

daylight savings 19

Desk or Wall Installation 13

dialpad, live 20

Direct Network Connection 8

Direct or Shared Network Connection 8

Directory key 7

E

expansion module, 536EM 4, 25

expansion module, 560EM 4, 25

expansion, module installing 26

H

Handset 12

headset mode 20

headset, making and receiving calls with 24

headset/speaker mode 20

I

indicator light 22

Inline Power Not Provided 11

Inline Power Provided 10

Install on the Desk 13

Install on the Wall 14

Installation 6

Installation and Setup 8

Intercom key 7

Introduction 1, 31

K

Key Description 5

L

language 18

lights or LEDs

 MWI 22

 speaker 22

 status 22

locking the phone 21

M

message waiting, clearing 19

microphone volume, headset 21

MWI (message waiting indicator) 22

N

network

 configuration settings for 21

O

Optional Accessories 5

Other Phone Features 22

P

Phone Features 1

Phone Parts 3

phone status 21

programmable keys 23

R

Requirements 1

ring tone, setting 19

S

Services key 7

Shared Network Connection 9

SIP settings 21

Softkeys 23

speaker mode 20

speaker/headset mode 20

T

time

setting format 19

setting time 19

setting time server 18

setting time zone 19

tone set, setting 19

troubleshooting solutions 28

U

user password 21

V

volume, adjusting 22

W

Warranty 31

Web UI, using 17