



TDM800P



User Manual



© Digium, Inc. 2006
All rights reserved.

No part of this publication may be copied, distributed, transmitted, transcribed, stored in a retrieval system, or translated into any human or computer language without the prior written permission of Digium, Inc.

Digium, Inc. has made every effort to ensure that the instructions contained in this document are adequate and error free. The manufacturer will, if necessary, explain issues which may not be covered by this documentation. The manufacturer's liability for any errors in the documents is limited to the correction of errors and the aforementioned advisory services.

This document has been prepared for use by professional and properly trained personnel, and the customer assumes full responsibility when using it.

Adobe and Acrobat are registered trademarks, and Acrobat Reader is a trademark of Adobe Systems Incorporated.

Asterisk and Digium are registered trademarks and Asterisk Business Edition is a trademark of Digium, Inc.

Any other trademarks mentioned in the document are the property of their respective owners.

Safety Certification and Agency Approvals

Safety: US/CSA 60950
IEC 60950
EN 60950

Other:

CE Mark
2002/95/EC Restrictions on Hazardous Substances (RoHS), 2005/747/EC
lead free exemption (Annex C)

Telecom:

FCC Part 68, ANSI/ITA-968-A, Including Amendment A1 and A2

EMC:

FCC Part 15 Class A
EN55022/CISPR22 Class A
EN55025
IEC 61000

Federal Communications Commission Part 68

This equipment complies with Part 68 of the FCC rules and the requirements adopted by the ACTA. On the back of the TDM800P printed circuit board is a label that contains, among other information, a product identifier in the format US:AAAEQ##TXXXX. If requested, this number must be provided to the telephone company.

A plug and jack used to connect this equipment to the premises wiring and telephone network must comply with the applicable FCC Part 68 rules and requirements adopted by the ACTA.

The REN is used to determine the number of devices that may be connected to a telephone line. Excessive RENs on a telephone line may result in the devices not ringing in response to an incoming call. In most but not all areas, the sum of RENs should not exceed five (5.0). To be certain of the number of devices that may be connected to a line, as determined by the total RENs, contact the local telephone company. For products approved after July 23, 2001, the REN is part of the product identifier that has the format US:AAAEQ##TXXXX. The digits represented by ## are the REN without a decimal point (e.g., 03 is a REN of 0.3).

If the TDM800P causes harm to the telephone network, the telephone company may notify you in advance that temporary discontinuance of service may be required. But if advance notice is not practical, the telephone company will notify you as soon as possible. Also, you will be advised of your right to file a complaint with the FCC if you believe it is necessary.

The telephone company may make changes in its facilities, equipment, operations or procedures that could affect the operation of the equipment. If this happens, the telephone company will provide advance notice in order for you to make necessary modifications to maintain uninterrupted service.

If you experience problems with the TDM800P, contact Digium, Inc. at 1.877.LINUX.ME (1.877.546.8963) for repair and/or warranty information. If the equipment is causing harm to the telephone network, the telephone company may request that you disconnect the equipment until the problem is resolved.

Connection to party line service is subject to state tariffs. Contact the state public utility commission, public service commission, or corporation commission for information.

Federal Communications Commission Part 15

This device complies with Part 15 of FCC rules. Operation is subject to the following two conditions: (1) This device may not cause harmful interference, and (2) This device must accept any interference received, including interference that may cause undesired operation.

Industry Canada

This Class A digital apparatus meets all requirements of the Canadian Interference-Causing Equipment Regulation.

Cet appareil numérique de la class A respecte les exigences du Reglement sur le Material Brouilleur du Canada.

Introduction to TDM800P Documentation

This manual contains product information for the TDM800P card. Be sure to refer to any supplementary documents or release notes that were shipped with your equipment. The manual is organized in the following manner:

Chapter/ Appendix	Title	Description
1	Overview	Identifies the card and type of modules you received with the TDM800P. This chapter covers applications and uses of the TDM800P in the real world.
2	Card Installation	Provides instructions for installing the card in your PC, acquiring correct drivers, and checking device compatibility.
3	Configuration	Provides examples for configuring dial plan options.
4	FXS and FXO Explained	Describes the FXO (Foreign Exchange Office) and FXS (Foreign Exchange Station) modules and their significance.
5	Troubleshooting	Explains resolutions to common problems and frequently asked questions pertaining to card installation and usage.
A	Pin Assignments	Lists the connectors and pin assignments.
B	Specifications	Details card specifications.
C	Glossary and Acronyms	A list of terms and acronyms used throughout this manual.

Symbol Definitions



Caution statements indicate a condition where damage to the unit or its configuration could occur if operational procedures are not followed. To reduce the risk of damage or injury, follow all steps or procedures as instructed.



The ESD symbol indicates electrostatic sensitive devices. Observe precautions for handling devices. Wear a properly grounded electrostatic discharge (ESD) wrist strap while handling the device.



The Electrical Hazard Symbol indicates a possibility of electrical shock when operating this unit in certain situations. To reduce the risk of damage or injury, follow all steps or procedures as instructed.

Important Safety Instructions

User Cautions



Warning

This card must be used with the PC lid screwed down. Telecommunications network voltages exist inside the PC! The PC must be shut down and telecommunications line connection shall be removed before opening the PC.



Electrical Shock.

To reduce the risk of injury, damage to the unit or your equipment, do not attempt to touch the modules while they are powered. The case should be securely closed before power is applied to the unit.



Alarm Dialing Equipment.

If your home has specially wired alarm equipment connected to the telephone line, ensure the installation of the TDM800P does not disable your alarm equipment. If you have questions, consult your telephone company or a qualified installer.



Servicing.

Do not attempt to service this card unless specifically instructed to do so. Do not attempt to remove the card from your equipment while power is present. Refer servicing to qualified service personnel.



Water and Moisture.

Do not spill liquids on this unit. Do not operate this equipment in a wet environment.



Heat.

Do not operate or store this product near heat sources such as radiators, air ducts, areas subject to direct, intense sunlight, or other products that produce heat.



Caution.

To reduce the risk of fire, use only No. 26 AWG or larger telecommunication wiring for network connections.

User Cautions



Caution.

This card is not intended for home use. It must be used in restricted access locations and installed in UL Listed I.T.E. only.



Static Electricity.

To reduce the risk of damaging the unit or your equipment, do not attempt to open the enclosure or gain access to areas where you are not instructed to do so. Refer servicing to qualified service personnel.

Save these instructions for future reference.

Service Personnel Cautions



Warning.

This card must be used with the PC lid screwed down. Telecommunications network voltages exist inside the PC! The PC must be shut down and telecommunications line connection shall be removed before opening the PC.



Electrical Shock.

To reduce the risk of injury, damage to the unit or your equipment, do not attempt to touch the modules while they are powered. The case should be securely closed before power is applied to the unit.



Servicing.

Disconnect telecommunications network cable before opening the cover or removing the card from the mother equipment



Labeling.

*For safety reasons, only connect equipment with a Telecommunications Compliance label. This includes customer equipment previously labelled **Permitted** or **Certified***



Caution.

Only connect regulatory equipment (approved for use in your specific country) to the telecommunications network voltage circuit ports.

Service Personnel Cautions



Caution.

This card is not intended for home use. It must be used in restricted access locations and installed in UL Listed I.T.E. only.

TABLE OF CONTENTS

Chapter 1

Overview	15
What is Asterisk?	16

Chapter 2

Card Installation	17
Unpacking the Card	17
Shipment Inspection	18
Module Identification	18
Port Identification	18
FXS and FXO Connection	22
Hardware Installation	22
Software Installation	25

Chapter 3

Configuration	31
General Options	31
Voicemail	32
Dial Plan	33
Testing Your Configuration	34

Chapter 4

FXS and FXO Explained37
 Identification.37
 FXS Module37
 FXO Module.37

Chapter 5

Troubleshooting39
 The FXO module never seems to hang-up the line. How do I set it to hang-up?39
 I have echo problems on my FXO modules and I've tried the different solutions and still nothing works. What can I do?39
 Common Fixes for all cards40
 There is a slight echo. How can I adjust the sound quality?41
 How can I enable more features?41
 Where can I ask even more questions?42
 Maintenance Support Program42

Appendix A

Pin Assignments43

Appendix B

Specifications45

Appendix C

Glossary and Acronyms47

List of Figures

Figure 1: Sample Card Application15
Figure 2: TDM800P Card with Four Single Modules20
Figure 3: TDM800P Card with Two Quad Modules21
Figure 4: Insert the Card24
Figure 5: Connect Power for FXS Modules25
Figure 6: lspci Screen Shot28
Figure 7: dmesg Screen Shot32
Figure 8: Sample Application37

List of Tables

Table 1: Example TDM 800P Card Configurations 23
Table A-1: RJ11 Telco Port Connector47

Table Of Contents

Chapter 1

Overview

The TDM800P card is a versatile device used for connecting your phone network to the PSTN (Public Switched Telephone Network) world. This is accomplished through phone lines connected to the FXO (Foreign Exchange Office) ports and phones connected via the FXS (Foreign Exchange Station) ports. The card allows Asterisk PBX software to connect to your phone network, creating an office type telephony environment. There are a variety of applications where the TDM800P proves useful. An example is provided in the following figure.

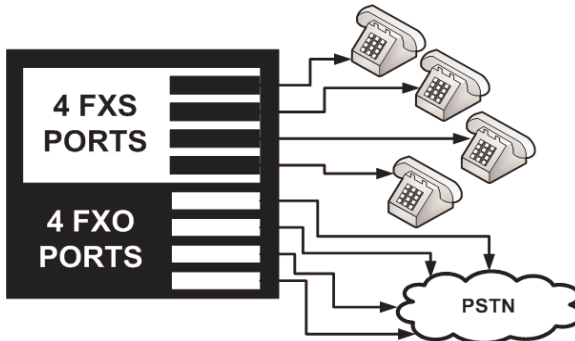

Figure 1: Sample Card Application

What is Asterisk?

Asterisk is the first Open Source PBX. Since it runs on Linux, it inherits all of the power and stability of the operating system. The name Asterisk is derived from the all-inclusive “wildcard” symbol in UNIX, because it is opening a wide range of opportunities for developers worldwide to create solutions which would otherwise be cost-prohibitive.

Asterisk allows you to create a PBX solution that rivals the features and functionality of traditional telephony switches. Current PBX solutions are expensive and proprietary. International companies are discovering that Asterisk is cost effective, low maintenance, and flexible enough to handle all of their voice and data networking. Combined with Digium hardware and a common PC, anyone can replace an existing switch or complement a PBX by adding VoIP, voicemail, conferencing, and many other capabilities. Asterisk will integrate with most standards-based IP telephone handsets and software. Analog phones and ADSI-screen phones are also supported.

Chapter 2

Card Installation

This chapter provides the following information:

- **Unpacking the Card** on page 17
- **Shipment Inspection** on page 18
- **Module Identification** on page 18
- **FXS and FXO Connection** on page 22
- **Hardware Installation** on page 22
- **Software Installation** on page 25

Unpacking the Card

When you unpack your card, carefully inspect it for any damage that may have occurred in shipment. If damage is suspected, file a claim with the carrier and contact your reseller from which the card was purchased, or Digium Technical Support at 1.877.LINUX.ME (1.877.546.8963). Keep the original shipping container to use for future shipment or proof of damage during shipment.

***Note:** Only qualified service personnel should install the card. Users should not attempt to perform this function themselves. The installer must ensure that the equipment is permanently connected equipment, pluggable type B or connected to a socket-outlet that has been checked to ensure that it is reliably earthed in accordance with the National Electrical Code.*



This card is intended for installation in a Restricted Access Location (RAL) only.

Shipment Inspection

The following items are included in shipment of the TDM800P:

- TDM800P card
- A combination of FXO and/or FXS modules
- User manual

Module Identification

The TDM800P card ships with FXO and/or FXS modules in place. These are identified by their color. Take a moment to identify which modules were shipped with your card.

- FXO (Foreign Exchange Office) modules are Red
- FXS (Foreign Exchange Station) modules are Green

See Figure 2 on page 20 for an example of the card shown with one of each quad module.

Port Identification

Each card consists of eight RJ11 ports located on the bracket. Each port correlates to a single module port (containing either FXO or FXS modules). The ports are numbered in sequence from one to eight. The top port is Port 1 and the bottom port is Port 8. See Figure 2 on page 20 for appropriate identification of these ports.

***Note:** It is important to identify the type and location of your TDM800P modules. You will need this information during the Asterisk configuration.*

The ports available for use on the TDM800P are not continuous. The ports available for use depend upon the type of module used, and the placement of the module on the card. The TDM800P can accept 2 quad modules, for a total of 8 ports. If single modules are used, only 2 single modules can occupy the same space as a quad module. The single module ports are identified on the card and their corresponding RJ11 ports are identified below. Please refer to Figure 2 for an example using single modules, and Figure 3 for an example using quad modules.

If a single module is used, the RJ11 port available for use will be the port corresponding to the location of the module on the card. The following ports correspond to the single module ports as shown in Figure 2.

- RJ11 Port 1 is used by Single Module Port 1
- RJ11 Port 2 is used by Single Module Port 2
- RJ11 Port 5 is used by Single Module Port 5
- RJ11 Port 6 is used by Single Module Port 6

If a quad module is placed covering single module ports 1 and 2, then that module will use ports 1-4. Likewise, if a quad module is placed covering single module ports 3 and 4, the module will use ports 5 through 8. Figure 3 shows a TDM800P with two quad modules.

There are multiple configurations in which the TDM800P card may be purchased. Each configuration consists of a combination of single modules, quad modules, or both. See Table 1 on page 21 for a complete list of possible configurations.

It is easiest to identify your card by understanding the naming scheme for each card. The second digit provides the number of FXS modules present on the card. The third digit provides the number of FXO modules present on the card. See Table 1 on page 21 for a complete list of possible configurations.

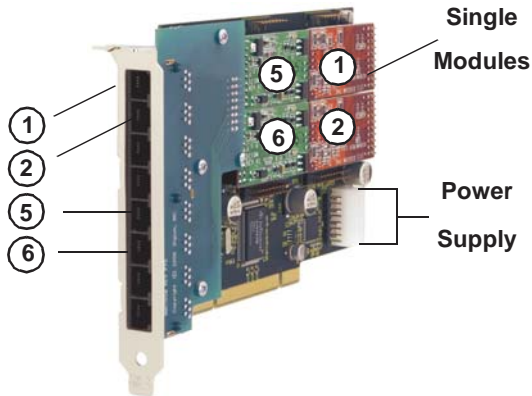

Figure 2: TDM800P Card with Four Single Modules

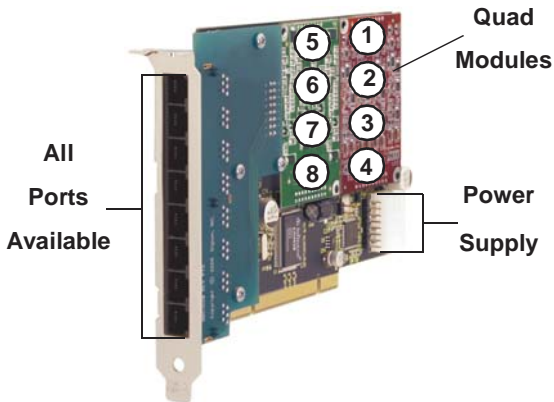

Figure 3: TDM800P Card with Two Quad Modules

Table 1: Example TDM 800P Card Configurations

Card ID	FXO/FXS Ports
TDM801	1 FXO ports
TDM802	2 FXO ports
TDM803	3 FXO ports
TDM804	4 FXO ports
TDM820	2 FXS ports
TDM822	2 FXS and 2 FXO ports
TDM824	2 FXS and 4 FXO ports
TDM830	3 FXS
TDM840	4 FXS
TDM842	4 FXS and 2 FXO ports
TDM844	4 FXS and 4 FXO ports

FXS and FXO Connection

The TDM800P card provides eight RJ11 connectors for access to the FXS and/or FXO modules installed in the available slots. The diagram in Table A-1 on page 43 provides the pinout for this connector.



Caution.

Only qualified service personnel should continue with hardware installation and configuration of the TDM800P card. Users should not attempt to perform these functions themselves.

Hardware Installation

1. Now that you are acquainted with your card, power down your computer and unplug it from its power source.
2. Attach a static strap to your wrist and open the case.
3. Remove the bracket place holder and insert the card into a 3.3 or 5 volt PCI slot (PCI 2.2 or greater). See Figure 4.

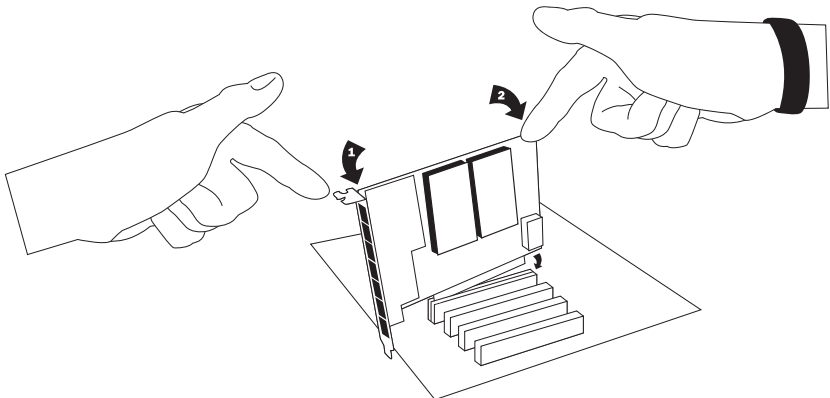

Figure 4: Insert the Card

4. If your card has any FXS modules, you will also need to connect the power cable from your computer's power supply to the back of the card. Insert a four-pin 12 volt connector (disk drive power supply cable, e.g. hard drive) into the white plastic connector on the rear of the card. See Figure 5.

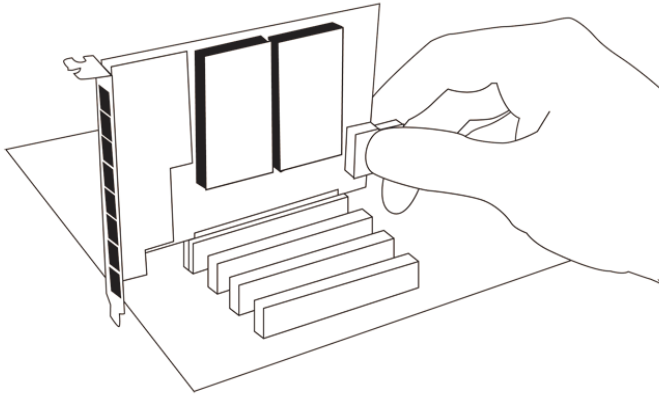

Figure 5: Connect Power for FXS Modules

Many modern PCs and servers do not have spare or any 12V power connectors. If you have FXS modules on your TDM card and your computer does not have power cables available, then power must be provided to the TDM card by an alternate means. Digium provides a solution to this problem with the optional PWR2400B (available separately). This card is essentially a PCI bracket assembly that takes power from an external DC power supply and routes it to two 15" power cables inside the computer. You must have an available bracket slot to use the PWR2400B (either PCI, PCI Express or AGP).

A strap on the PWR2400B card allows the two power cables to take power from the same DC supply. The PWR2400B does not connect to any bus inside the computer. It may be used wherever there is an available PCI-size bracket such as a PCI slot, PCI Express slot, or AGP slot.

Note: The PWR2400B is not intended to supply power to any other device, it is intended only to be used with UL Listed Digium TDM 800P or TDM2400P cards.

5. Replace the cover to your computer.



Electrical Shock.

To reduce the risk of injury, damage to the unit or your equipment, do not attempt to apply power to the unit while the case is open. Personal injury or damage to the unit could occur if the modules are touched while powered is applied.

6. Plug all outside phone lines to the FXO (red) ports and connect all phones to the FXS (green) ports as needed. See Table A-1 on page 43 for the pin assignments.



Caution.

This unit must be connected to the Telecommunications Network in your country using an approved line cord, e.g.: for Australia use only line cords complying with ACA Technical Standard TS008.



Caution.

Only connect regulatory equipment (approved for use in your specific country) to the telecommunications network voltage circuit ports.

Software Installation

The card is only supported under Linux. Digium, Inc. recommends Debian, Fedora, and Red Hat, however, all other distributions are supported by Digium Technical Support. Digium hardware requires drivers and libraries that are integrated with the Linux kernel. You can obtain the source code from <ftp.digium.com>. Detailed instructions are provided in this section.

To install your TDM800P card, you will need:

- Full Linux kernel 2.6 (or later) source code.
- Development libraries and headers for libncurses (only necessary for Asterisk).
- Development libraries and headers for zlib and openssl.
- If you are using the 1.2.x series of Asterisk and Zaptel, you will need Asterisk 1.2.15 or newer, and Zaptel 1.2.15 or newer. If you are using the 1.4.x series of Asterisk and Zaptel, you will need Asterisk 1.4.1 or newer and Zaptel 1.4.1 or newer. If you are using Asterisk Business Edition, you will need version B.2 or newer.

1. Check your **lspci** PCI device listing. Boot the computer into Linux. After the machine has loaded, log in and execute the following:

```
# lspci
```

Confirm your **lspci** PCI device listing by scanning for the following information in the output screen:

```
0000:01:01.0 Ethernet controller: Unknown device d161:0800 (rev 11)
Subsystem: Unknown device d161:0800
Flags: bus master, medium devsel, latency 32, IRQ 12
I/O ports at d800 [size=256]
Memory at ff8ffc00 (32-bit, non-prefetchable) [size=1K]
Expansion ROM at ff8c0000 [disabled] [size=128K]
Capabilities: [c0] Power Management version 2
```

Figure 6: lspci Screen Shot

A Digium TDM800P module should be identified. If you do not identify this controller, then your machine is not PCI 2.2 (or higher) compatible and the card will not work with your equipment.

2. Download the latest Zaptel drivers (1.2.15 or later). The Zaptel drivers can be downloaded using either ftp or http. They are accessible via ftp from <ftp://ftp.digum.com/pub/zaptel/>. They are accessible via http from <http://ftp.digium.com/pub/zaptel/>.

3. Expand the downloaded tarballs:

```
#tar -zxvf zaptel-1.X.X.tar.gz
#cd zaptel-1.X.X
#make
#make install
```

Note: If you don't already have configuration files installed, you can type **make samples** to install the default sample configuration files.

4. Download the latest released version of Asterisk (1.2.15 or later).

Asterisk can be downloaded using ftp or http.

It is accessible via ftp from <ftp://ftp.digium.com/pub/asterisk>.

It is also accessible via http from <http://ftp.digium.com/pub/asterisk>.

5. Expand the downloaded tarballs:

```
# tar -zxvf asterisk-1.2.xx.tar.gz
# cd asterisk-1.2.xx/
# make
# make install
```

Note: Substitute the version of Asterisk you are using with the XX in the above command line.

Note: If the build fails, it may be because you are missing one of the build dependencies, the kernel source, or development tools. Feel free to contact your reseller where the card was purchased, or call Digium Technical Support at 1.877.LINUX.ME (1.877.546.8963) for assistance.

Note: Complete instructions for installing Asterisk are available at www.asterisk.org.

Zaptel Configuration

The following steps are necessary for Zaptel configuration:

1. If your card has any red FXO modules, add the following:

```
fxsks
```

This uses kewl start signalling which is loop start with disconnect supervision. For example, a TDM808P card would be configured as the following:

```
fxsks=1,2,3,4,5,6,7,8
```

Note: You should have identified the type of TDM800P card when you received it. If you are not sure, refer to **Module Identification** on page 18 for assistance.

2. If your card has any green FXS modules, add the following:

```
fxoks
```

This uses kewl start signalling which is loop start with disconnect supervision. For example, a TDM880P card would be configured as the following:

```
fxoks=1,2,3,4,5,6,7,8
```

An example TDM844P card configuration would be:

```
fxoks=1,2,3,4
```

```
fxsks=5,6,7,8
```

3. Set your loadzone and default zone for your country. If you are not in the United States, you will want to change the default configuration from **US** to your own two letter country abbreviation. Save the file and return to the command line.

```
#modprobe wctdm24xxp
```

```
#ztcfg -vv
```

Note: The TDM800P card uses the same driver for this setting as the TDM2400.

4. Confirm the card configuration by initiating a `dmesg` command. The example in Figure 7 on page 30 shows a sample of the **dmesg** screen output for a TDM844P card. The text shown may vary slightly depending on the type of card installed:

```
ACPI: PCI interrupt 0000:01:01.0[A] -> GSI 22
(level, low) -> IRQ 201
PCI Config reg is 02900117
TDM800P: New Reg: fe590000!
Detected REG0: 00000100
Detected REG1: 00007849
Detected REG2: 0000001d
(pre) Reg fc is 50000027
(post) Reg fc is 50000024
Detected REG2: 0000ffff
TDM800P: reg is a04c0004
Resetting the modules...
During Resetting the modules...
After resetting the modules...
Port 1: Installed -- AUTO FXO (FCC mode)
Port 2: Installed -- AUTO FXO (FCC mode)
Port 3: Installed -- AUTO FXO (FCC mode)
Port 4: Installed -- AUTO FXO (FCC mode)
Port 5: Installed -- AUTO FXO (FCC mode)
Port 6: Installed -- AUTO FXO (FCC mode)
Port 7: Installed -- AUTO FXO (FCC mode)
Port 8: Installed -- AUTO FXO (FCC mode)
Found a Wildcard TDM: TDM800P (8 modules)
```

Figure 7: dmesg Screen Shot

Note: You will make changes to the configuration files to set up your dial plan and customize Asterisk to suit your particular needs. These changes are stored in the `/etc/zaptel.conf` configuration file.

Chapter 3

Configuration

This chapter provides sample configurations to demonstrate customizing the Asterisk software to meet your individual needs. Each section explains basic options as examples. Once you have familiarized yourself with the samples, you can edit the configuration files to meet your specific needs.

Note: Only qualified service personnel should install the card. Users should not attempt to perform this function themselves.

General Options

Open the **zapata.conf** file from the **/etc/asterisk/** directory.

The following is a sample configuration for a TDM822P card. You can place this at the bottom of your **zapata.conf** file.

```
;;General options
usecallerid=yes
hidecallerid=no
callwaiting=yes
threewaycalling=yes
transfer=yes
echocancel=yes
echocancelwhenbridged=yes
rxgain=0.0
txgain=0.0
;;FXS Modules
```

```
Group=1
signalling=fxo_ks
context=Internal
channel=1-2
```

```
;;FXO Modules
Group=2
echocancel=yes
signalling=fxs_ks
context=Incoming
channel=3-4
```

Voicemail

Open **voicemail.conf** and find the following line at the bottom:

```
[default]
1234 => 4242, Mark Spencer, root@localhost
```

In this example, **1234** is the mailbox number, **4242** is the password, **Mark Spencer** is the person's name, and **root@localhost** is his email address.

You can add extensions by adding the following:

```
1000 => 1234, Moose Member, moose@digium.com
2000 => 1234, Bill Savage, bsavage@digium.com
```

Dial Plan

Open **extensions.conf**, which contains a large, complex sample dial plan. In this step, you will configure a basic dial plan to enable you to send and receive calls. Go to the bottom of the file and add the following lines:

```
[Internal]
exten => 1000,1,Dial(zap/1,20,rt)
exten => 1000,2,Voicemail(u1000)
exten => 1000,102,Voicemail(b1000)

exten => 2000,1,Dial(zap/2,20,rt)
exten => 2000,2,Voicemail(u2000)
exten => 2000,102,Voicemail(b2000)

exten => 8500,1,VoiceMailMain
exten => 8501,1,MusicOnHold

exten => _9.,1,Dial(zap/g2/www${EXTEN:1})
exten => _9.,2,Congestion

[Incoming]
exten => s,1,Answer
exten => s,2,Dial(zap/g1,20,rt)
exten => s,3,Voicemail(u1000)
exten => s,103,Voicemail(b1000)
```

In this example there are two internal extensions (1000 and 2000), a number to check voicemail (8500), a number to listen to musiconhold, (8501), and a prefix to dial to get an outside line (9). It is configured for

incoming calls over the FXO rings phones 1 and 2, and voicemail is routed to mailbox 1000.

Testing Your Configuration

1. Start Asterisk by typing:

```
asterisk
```

2. Connect to Asterisk and view the output by typing:

```
asterisk -vvvvv
```

3. Dial tone should be present on phones connected to the FXS ports. Test your configuration by placing an outgoing call, placing a call from extension 1 to 2, or receiving an incoming call. Successful completion of these tasks indicates your configuration is working properly.

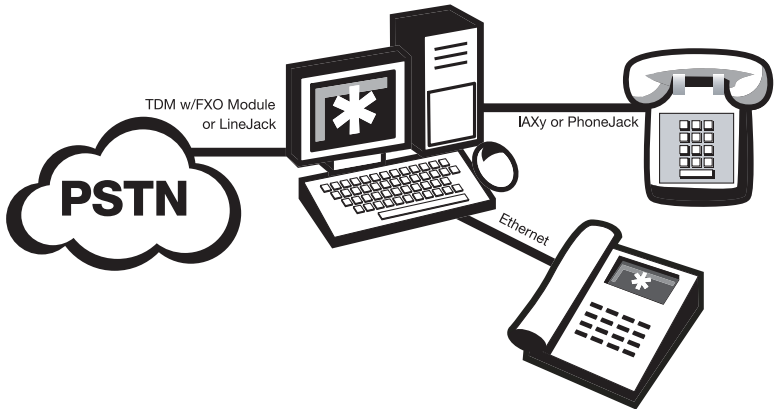

Figure 8: Sample Application

Note: More detailed information is provided on troubleshooting in the Asterisk User's Manual. A copy may be requested by contacting Digium Technical Support at 1.877.LINUX.ME (1.877.546.8963) or visiting the website at www.digium.com. You may also contact your distributor or reseller where the card was purchased for assistance.

Chapter 4

FXS and FXO Explained

Identification

There are multiple standard configurations in which the TDM800P card may be purchased. Each configuration consists of one to four FXS and/or FXO modules. These modules are identified by their color.

- **FXS** - Foreign Exchange Station (Green Modules)
- **FXO** - Foreign Exchange Office (Red Modules)

This chapter provides an in-depth review of the two module types and their uses within your Asterisk server.

Note: Only qualified service personnel should install the card. Users should not attempt to perform this function themselves.

FXS Module

The FXS module allows the TDM800P card to initiate and send ringing voltage to an FXO device such as an analog telephone.

FXO Module

The FXO module allows the TDM800P card to terminate analog telephone lines (POTS).

Because of the modular design, you can activate additional ports at any time with more FXS or FXO daughter cards. The FXO module passes all the call features any standard analog telephone line will support. The

phone receiving the call is the last FXO device in the chain. When it receives voltage from an FXS device, the phone rings.

Chapter 5

Troubleshooting

This chapter provides frequently asked questions as identified from Digium Technical Support and possible resolutions. Multiple resources are available to obtain more information about Asterisk and Digium products. Please visit both www.digium.com and www.asterisk.org for more information.

The FXO module never seems to hang-up the line. How do I set it to hang-up?

Set **busydetect=yes** and **busycount=10** in the **zapata.conf** for your channels. This will cause the line to hang-up by listening for the busy tone. Upon editing **zapata.conf**, you will need to restart Asterisk.

I have echo problems on my FXO modules and I've tried the different echo cancellation algorithms in zconfig.h, tried tweaking the gains, and still nothing works. What can I do?

Use the `fxotune` utility.

To use: Just run the `fxotune` utility with the `-i` option (`fxotune -i 4`). It should discover which zap channels are FXO modules and tune them accordingly. Be warned however, it takes a significant amount of time for EACH module to test, I would say somewhere around 2-3 minutes. But you only have to initialize it once for the line. It will write a configuration file to `/etc/fxotune.conf`. You will need to have your system run `fxotune`

with the `-s` flag (`fxotune -s`) to set the module with the previously discovered values from `fxotune.conf` for it to take affect, so essentially if each time you reboot the machine you need to run `fxotune -s`. You might consider putting it in your startup scripts some time after the module loads and before asterisk runs.

Note: The digit after the `-i` option is the digit that will break dialtone on the line.

Common Fixes for all cards

1. Check for shared interrupts by entering the following:

```
cat /proc/interrupts
```

and

```
lspci -vb
```

If a conflict exists, try moving the card to another PCI slot.

2. Check to see if X windows is running by entering the following:

```
ps aux|grep X
```

If X windows is running, stop the application since it may cause a conflict with Asterisk.

3. Check to see if your IDE hard drives are running with DMA levels set. Advance user can perform an **hdparm** on your hard drive interface.



Use `hdparm` with caution as the man page states that hard drive corruption can occur when using incorrect settings. Please review the man page for `hdparm` and make sure you understand the risks before using this tool.

Check the current mode using this command:

```
hdparm -vi /dev/[IDE Device]
```

Use this command to set the drives into UDMA2 mode:

```
hdparm -d 1 -X udma2 -c 3 /dev/[IDE Device]
```

If you are still having problems, contact your reseller from which the card was purchased, or Digium Technical Support at 1.877.LINUX.ME (1.877.546.8963).

There is a slight echo. How can I adjust the sound quality?

There are several options available to correct this. Each involves editing the **zapata.conf** file. Be sure to restart Asterisk upon completion.

- 1.** Adjust **echocancel=yes** to one of the following values: **32, 64, 128, or 256**.
- 2.** You can also set **echotraining=yes**.
- 3.** You can also adjust the **rxgain** and the **txgain**, although it is only recommended to shift between **-5** and **5**.

How can I enable more features?

To view all of the options available to add to your dial plan, type the following command from within Asterisk:

```
show applications
```

Where can I ask even more questions?

There are several places to inquire for more information about Asterisk Digium products:

1. Digium Technical Support at 1.877.LINUX.ME (1.877.546.8963) is available 7am-7pm Central Time (GMT -6), Monday - Friday.
2. Asterisk users mailing list (asterisk.org/lists.digium.com).
3. IRC channel **#asterisk** on (irc.freenode.net).

Maintenance Support Program

Digium is dedicated to supporting your Asterisk system by offering full technical support through our Maintenance Support Program. The Maintenance Support Program covers all Digium hardware and the complete Asterisk software suite. Through this program, you can be at ease knowing that your business will always have access to the Asterisk experts. To obtain a quote for maintenance please contact Asterisk Express sales at +1.256.428.6060 or express@digium.com.

Appendix A

Pin Assignments

All eight ports on the TDM800P bracket are 6-pin RJ11 ports. The pin assignments are identified in Table A-1.

Table A-1: RJ11 Telco Port Connector

	Pin	Description
	1	Not used
	2	Not used
	3	Tip
	4	Ring
	5	Not used
	6	Not used

Appendix B

Specifications

This appendix provides specifications, required environmental conditions, and maximum power consumption for the TDM800P card.

Physical.

Size: 6.48" × 4.2" × 0.68" (31.19 x 10.67 x 1.72 cm)
PCB size, does not include the PCI bracket or retainer.
Check your model carefully to be sure it will accept this PCI card.

Weight: 4.5 oz (127.58 gm) with no modules loaded
Each quad module adds 1 oz (28.35 gm)

Interfaces.

Local Loop Access: Industry standard 6-pin RJ-11.

PCI Bus: 3.3V or 5V bus slot, half-length full-height PCI card, 33MHz minimum bus speed, compliant with PCI 2.2 or greater.

Additional Power: four-pin 12V connector for FXS power supply (required only if FXS modules are installed)

Environment.

Temperature: 0 to 50° C (32 to 122° F) operation
-20 to 65° C (-4 to 149° F) storage

Humidity: 10 to 90% non-condensing

Note: Operating temperature is limited to 0 to 40° C (32 to 104°F) when used with optional PWR2400B Power Bracket

Hardware and Software Requirements.

500-Mhz Pentium III or better

64MB RAM

Available PCI Slot (as described previously)

Table B-2: Maximum Power Consumption

Model	Power
3.3V All models	1W
5V All models	9W
12V TDM804E	0W
TDM808E into 1REN	0W
TDM844E into 2REN	6.5W
TDM840E into 3REN	6.5W
TDM880E into 5REN	13W

Note: 3.3 and 5 volt power is taken from the PCI slot. 12 volt power is taken only from the four-pin hard disk drive connector or optional PWR2400B.

Appendix C

Glossary and Acronyms

ANSI *American National Standards Institute*

An organization which proposes and establishes standards for international communications.

asynchronous

Not synchronized; not timed to an outside clock source. Transmission is controlled by start bits at the beginning and stop bits at the end of each character. Asynchronous communications are often found in internet access and remote office applications.

attenuation

The dissipation of a transmitted signal's power as it travels over a wire.

bandwidth

The capacity to carry traffic. Higher bandwidth indicates the ability to transfer more data in a given time period.

bit

The smallest element of information in a digital system. A bit can be either a zero or a one.

bps *bits per second*

A measurement of transmission speed across a data connection.

broadband

Broadband transmission shares the bandwidth of a particular medium (copper or fiber optic) to integrate multiple signals. The channels take up different frequencies on the cable, integrating voice, data, and video over one line.

channel

A generic term for an individual data stream. Service providers can use multiplexing techniques to transmit multiple channels over a common medium.

Cat5

Category of Performance for wiring and cabling. Cat 5 cabling support applications up to 100 MHz.

Cat5E

Category of Performance for wiring and cabling. Category 5 Enhanced wiring supports signal rates up to 100 MHz but adheres to stricter quality specifications.

CLEC *competitive local exchange carrier*

A term for telephone companies established after the Telecommunications Act of 1996 deregulated the LECs. CLECs compete with ILECs to offer local service. See also *LEC* and *ILEC*.

CO *central office*

The CO houses local switching equipment. All local access lines in a particular geographic area terminate at this facility (which is usually owned and operated by an ILEC).

CPE *customer premises equipment*

Terminal equipment which is connected to the telecommunications network and which resides within the home or office of the customer. This includes telephones, modems, terminals, routers, and television set-top boxes.

DS0 *Digital Signal, Level 0*

A voice grade channel of 64 Kbps. The worldwide standard speed for digitizing voice conversation using PCM (Pulse Code Modulation).

DS1 *Digital Signal, Level 1*

1.544 Mbps in North America (T1) and Japan (J1) -up to 24 voice channels (DS0s), 2.048 Mbps in Europe (E1) - up to 32 voice channels (DS0s). DS1/T1/E1 lines are part of the PSTN.

DS3 *Digital Signal, Level 3*

T3 in North America and Japan, E3 in Europe. Up to 672 voice channels (DS0s). DS3/T3/E3 lines are not part of the PSTN

DTMF *Dual Tone Multi-Frequency*

Push-button or touch tone dialing.

E1

The European equivalent of North American T1, transmits data at 2.048 Mbps, up to 32 voice channels (DS0s).

E3

The European equivalent of North American T3, transmits data at 34.368 Mbps, up to 512 voice channels (DS0s). Equivalent to 16 E1 lines.

EMI *Electromagnetic Interference*

Unwanted electrical noise present on a power line

full duplex

Data transmission in two directions simultaneously.

FXO *Foreign Exchange Office*

Receives the ringing voltage from an FXS device. Outside lines are connected to the FXO port on your TDM800P card.

FXS *Foreign Exchange Station*

Initiates and sends ringing voltage. Phones are connected to the FXS ports on the TDM800P card.

G.711

The International Telecommunications Union recommendation for an algorithm designed to transmit and receive maelaw PCM voice and A-law at digital bit rate 64 Kbps. This algorithm is used for digital telephone sets on digital PBX.

G.729

The International Telecommunications Union standard for voice algorithm.

H.323

The International Telecommunications Union standard for multimedia communications over packet-based networks.

IAX *Inter-Asterisk eXchange*

The protocol used by Asterisk. It is used to enable VoIP connections between Asterisk servers, and between servers and clients that also use the IAX protocol.

iLBC *internet Low Bitrate Codec*

A free speech codec used for voice over IP. It is designed for narrow band speech with a payload bitrate of 13.33 kbps (frame length = 30ms) and 15.2 kbps (frame length = 20 ms).

ILEC *incumbent local exchange carrier*

The LECs that were the original carriers in the market prior to the entry of competition and therefore have the dominant position in the market.

interface

A point of contact between two systems, networks, or devices.

ISO *International Standards Organization*

LED *light-emitting diode*

Linux

A robust, feature-packed open source operating system based on Unix that remains freely available on the internet. It boasts dependability and offers a wide range of compatibility with hardware and software. Asterisk runs exclusively on Linux.

loopback

A state in which the transmit signal is reversed back as the receive signal, typically by a far-end network element.

MGCP *Media Gateway Control Protocol*

multiplexing

Transmitting multiple signals over a single line or channel. FDM (frequency division multiplexing) and TDM (time division multiplexing) are the two most common methods. FDM separates signals by dividing the data onto different carrier frequencies, and TDM separates signals by interleaving bits one after the other.

MUX *multiplexer*

A device which transmits multiple signals over a single communications line or channel. See multiplexing.

PBX *private branch exchange*

A smaller version of a phone company's large central switching office.
Example: Asterisk.

PCI *peripheral component interconnect*

A standard bus used in most computers to connect peripheral devices.

POP *point of presence*

The physical connection point between a network and a telephone network. A POP is usually a network node serving as the equivalent of a CO to a network service provider or an interexchange carrier.

POTS *plain old telephone service*

Standard phone service over the public switched telephone network (PSTN). This service provides analog bandwidth of less than 4 kHz.

PPP *point-to-point protocol*

Type of communications link that connects a single device to another single device, such as a remote terminal to a host computer.

PSTN *public switched telephone network*

A communications network which uses telephones to establish connections between two points. Also referred to as the dial network.

QoS *quality of service*

A measure of telephone service, as specified by the Public Service Commission.

RJ11

A six pin jack typically used for connecting telephones, modems, and fax machines in residential and business settings to PBX or the local telephone CO.

SIP *Session Initiation Protocol*

An IETF proposed standard for setting up sessions between one or more clients. It is currently the leading signaling protocol for Voice over IP, gradually replacing H.323.

T1

A dedicated digital carrier facility which transmits up to 24 voice channels (DS0s) and transmits data at 1.544 Mbps. Commonly used to carry traffic to and from private business networks and ISPs.

T3

A dedicated digital carrier facility which consists of 28 T1 lines and transmits data at 44.736 Mbps. Equivalent to 672 voice channels (DS0s).

TDM *time division multiplexer*

A device that supports simultaneous transmission of multiple data streams into a single high-speed data stream. TDM separates signals by interleaving bits one after the other.

telco

A generic name which refers to the telephone companies throughout the world, including RBOCs, LECs, and PTTs.

tip and ring

The standard termination on the two conductors of a telephone circuit; named after the physical appearance of the contact areas on the jack plug.

twisted pair

Two copper wires commonly used for telephony and data communications. The wires are wrapped loosely around each other to minimize radio frequency interference or interference from other pairs in the same bundle.

V *volts*

VoIP *Voice over IP*

Technology used for transmitting voice traffic over a data network using the Internet Protocol.

Zap

Digium hardware interface.

