



**ENGLISH
DEUTSCH
FRANÇAIS
ITALIANO
ESPAÑOL
PORTUGUÊS**

Quick Start Guide

snom 300

VoIP Business Phone

A

**Delivery content - Lieferumfang - Contenu de l'emballage -
En la caja - Contenuto della confezione - Incluídos no pacote**

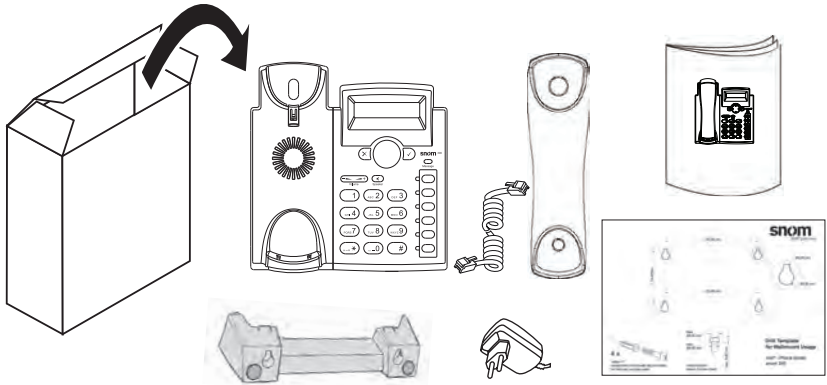

- Not included: Ethernet cable - compatible with
- Nicht im Lieferumfang enthalten: Ethernet-Kabel - kompatibel mit
- Non inclus: Câble Ethernet - compatible avec
- No incluido: Cable de Ethernet - compatible con
- Non inclusos: Cavo Ethernet - compatibile con
- Não incluído: Cabo Ethernet - compatível com

} IEEE 802.3af

B

**Attaching the Footstand - Fuß montieren - Attacher le pied -
Montaje el soporte - Fissare il supporto - Anexar o Suporte**

1

- for desktop placement
- für Schreibtischaufstellung
- pour le placement sur un bureau
- para la colocación en un escritorio
- per il posizionamento su una scrivania
- para a colocação em uma mesa

2

- for wall mounting
- für die Wandbefestigung
- pour l'installation sur le mur
- para el montaje en pared
- per il montaggio a parete
- para montagem na parede

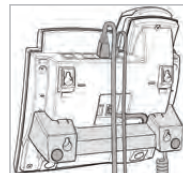

1

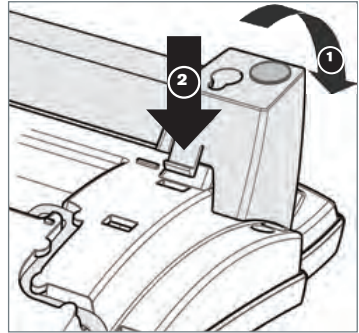
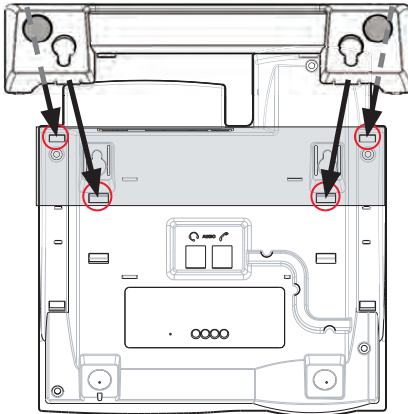

2

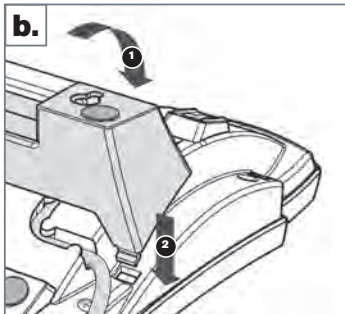
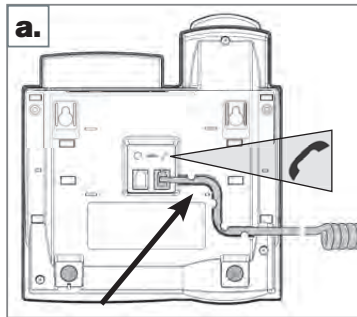
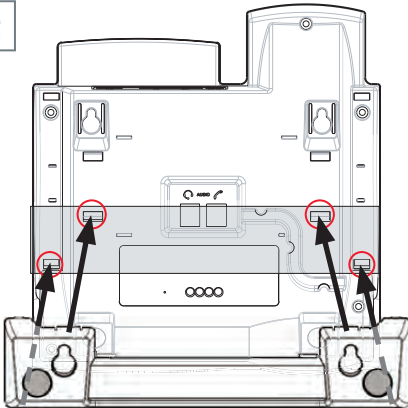

C

**Detaching the Footstand - Fuß abmontieren - Démontér le pied -
Desmontar el soporte - Smantellare il supporto - Destacandar o Suporte**

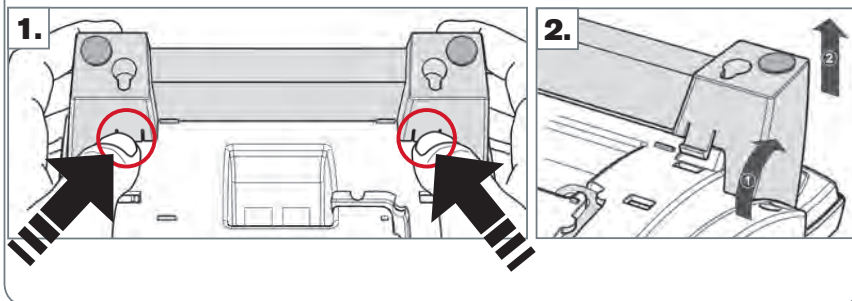
**D**

**Wall Mounting - Wandmontage - Fixation murale -
Montaje en pared - Montaggio a parete - Montagem na parede**

Not included in delivery:
Nicht im Lieferumfang enthalten:
Non inclus:
No incluidos:
Non inclusos:
Não incluído:

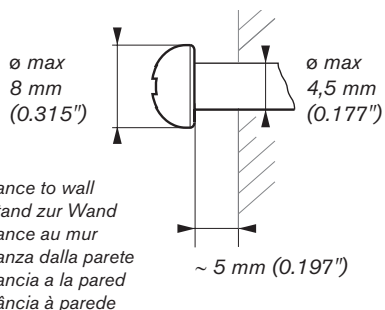
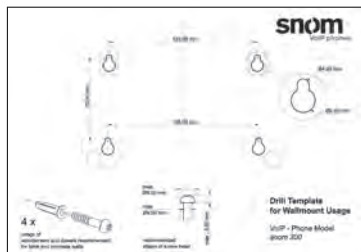
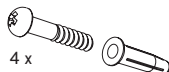

*Distance to wall
Abstand zur Wand
Distance au mur
Distanza dalla parete
Distancia a la pared
Distância à parede*

E

Connecting - Anschließen - Connector - Conectar - Collegare -

1.

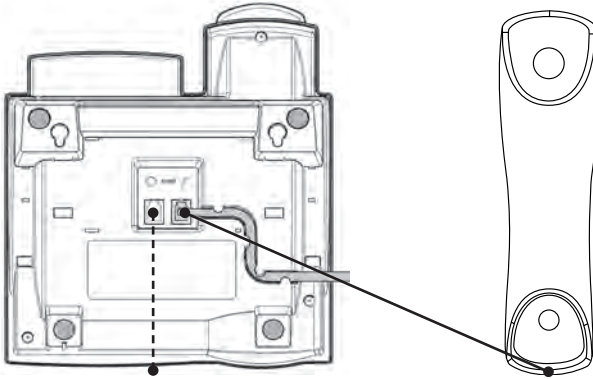

Optional
Optionel
Opzionale
Opcional



2.

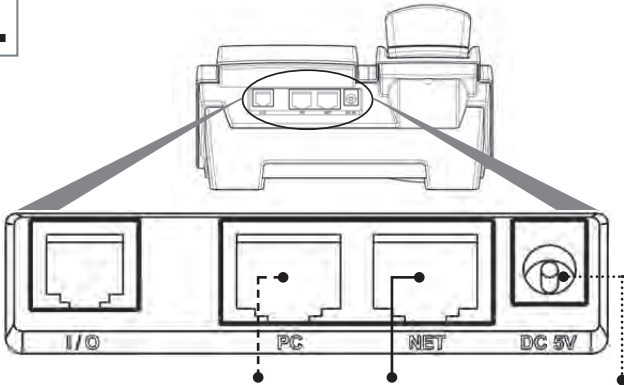

Optional
Optionel
Opzionale
Opcional



If no PoE available
Wenn PoE nicht verfügbar
S'il n'y a pas de PoE
Si no se dispone de PoE
Se non disponibile PoE
Se não disponível PoE

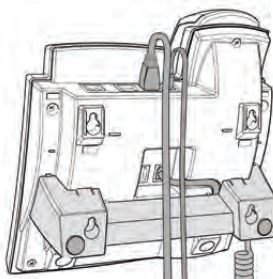
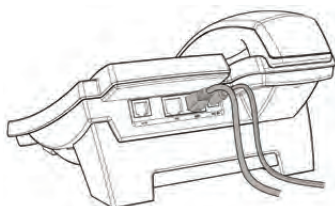

ENGLISH 7

DEUTSCH 15

FRANÇAIS 23

ITALIANO 31

ESPAÑOL 39

PORTUGUÊS 47

APPENDIX • ANHANG • ANNEXE • APENDICE • ANEXO

GNU General Public License 55

Symbols used in this guide	♦	In dieser Anleitung benutzte Symbole
Symboles utilisés dans ce manuel	♦	Simboli utilizzati in questa manuale
Símbolos usados en este manual	♦	Símbolos utilizados neste manual



>:	Next step	♦ Nächster Schritt
	Passez à l'étape suivante	♦ Passo successivo
	Siguiente paso	♦ Próxima etapa

ENGLISH

This quick start guide describes the installation, setup, and operation of the snom 300. For further information please refer to the manual on our web page,

<http://wiki.snom.com/Snom300>.

Copyright, Trademarks, GPL, Legal Disclaimers

© 2010 snom technology Aktiengesellschaft
All Rights Reserved.

snom, the names of snom products, and snom logos are trademarks owned by snom technology AG. All other product names and names of enterprises are the property of their respective owners.

snom technology AG reserves the right to revise and change this document at any time, without being obliged to announce such revisions or changes beforehand or after the fact.

Texts, images, and illustrations and their arrangement in this document are subject to the protection of copyrights and other legal rights worldwide. Their use, reproduction, and transmittal to third parties without express written permission may result in legal proceedings in the criminal courts as well as civil courts.

Although due care has been taken in the compilation and presentation of the information in this document, the data upon which it is based may have changed in the meantime. snom therefore disclaims all warranties and liability for the accurateness, completeness, and currentness of the information published, except in the case of intention or gross negligence on the part of snom or where liability arises due to binding legal provisions.

Our firmware includes some source code that may be used and modified by anyone and everyone under the GNU Public License (GPL) (see Appendix on page 55), provided they, in turn, make it available to everyone else with the same licensing agreement. Please go to <http://www.snom.com/en/support/download/gpl-quellcode/> for the original GPL license and the source code of components licensed under GPL and used in snom products.

Important Information

Please read the instructions on safety and disposal and on how to set up and use the device before using it and also give them to other users to read or inform those users of their contents. Save this manual and do not give the device to third parties without it.

Safety Instructions

Follow the instructions in this manual and other applicable documentation of the device.

- If the phone is not supplied with power via an Ethernet cable, use only the power adapter included in the package or one expressly recommended by snom technology. Other power supplies may damage or destroy the phone, affect its behavior, or induce noise.

- Avoid placing the cables where people may trip over them or where they may be exposed to mechanical pressure as this may damage them.
- This device is for indoor use only! Do not install outdoors - **NOT FOR OUTDOOR USE!**
- Do not install the device in rooms with high humidity (for example, in bathrooms, laundry rooms, damp basements). Do not immerse the device in water and do not spill or pour liquids of any kind onto or into the device.
- Do not install the device in surroundings at risk for explosions (paint shops, for example). Do not use the device if you smell gas or other potentially explosive fumes.
- Do not use the device during thunderstorms. Lightning striking the power grid may cause electric shocks.
- Warning: The handpiece contains magnets and the earpiece or mouthpiece may attract and hold small dangerous objects such as pins. Please ensure no such objects are present before each use.

SELV (Safety Extra Low Voltage) Compliance

Safety status of Input/Output connections comply with SELV requirements.

Warning: To avoid electric shock, do not connect safety extra-low voltage (SELV) circuits to telephone-network voltage (TNV) circuits. LAN ports contain SELV circuits, and PSTN ports contain TNV circuits. Some LAN and PSTN ports both use RJ-45 (8P8C) connectors. Use caution when connecting cables.

Standards conformance



This device is CE and FCC-certified and meets European and US health, safety, and environmental standards.

Unauthorized opening, changing, or modifying the device will cause the warranty to lapse and may also result in the lapse of the CE and FCC certifications. In case of malfunction contact authorized service personnel, your seller, or snom.

- **Safety:** IEC 60950-1:2001, CB Test Certificate: DE 2-013297
- **Certifications:** FCC Class B, CE Mark
- **Power consumption:** 1.7 – 2.7 watts
- **Power:** 5 V DC
- **1 x LAN, 1 x PC:** RJ45 (Ethernet)
- **Ethernet:** 2x IEEE 802.3 10/100 Mbps switch
- **Power over Ethernet:** IEEE 802.3af, Class 1

Disposal of the device



This device is subject to European Directive 2002/96/EC and may not be disposed of with general household garbage.

If you do not know where you may dispose of the device at the end of its lifespan, contact your municipality, your local waste management provider, or your seller.

Cleaning



To clean the device, use an anti-static cloth. Please avoid cleaning liquids as they might damage the surface or internal electronics of the device.

Initializing and registering the phone

Please note: You will need the registration information received from your Internet service provider or your network administrator - normally the phone or extension number, the password, and the registrar.

After you have set up the phone and connected it to the network as shown on pages 2 - 5, the phone begins to initialize.

Normally the initialization is completely automatic, using DHCP. If your network does not support DHCP, you must obtain the IP address, netmask, IP gateway, and DNS server from your Internet service provider or your network administrator and enter them manually when you are asked to do so on the display.

Watch the display and, when asked to, make selections with  and save with .

1. Language. The default is English. Other languages are available if the phone/network is connected to the Internet during initialization, so that they can be provided from the snom server automatically (firmware 7 and higher).
2. Dial tone
3. Time zone
4. Enter the account number. Save with ✓.
5. Enter the registrar. Save with ✓. The display now shows the idle screen:



Account → 156 16:05 ← Time
 ← Currently used audio device

Entering numerals, letters, and special characters

The current input mode is indicated on the display by "123" (digits), "abc" (small letters), "ABC" (capital letters).

▼	Change input mode	▲	Delete sign to the left of the cursor
◀	Move cursor to the left	▶	Move cursor to the right

Entering special characters and symbols in letter input mode: Press "1" key one or more times quickly, with a pause after each character. Examples:

1x = "." 2x = "+" 3x = "@" 4x = "1" 5x = ":"

At a glance

Navigation key

Navigating in menus and lists. From idle screen:

- Call lists: ▲
- Settings menu: ▼

Cancel key

Cancelling actions and input

Audio control keys

- Adjusting volume
- Turning speakerphone on/off

Alphanumeric keypad

Star key

- Switching between upper & lower case when pressed briefly while in editing mode
- Locking & unlocking the keyboard when pressed for a few seconds

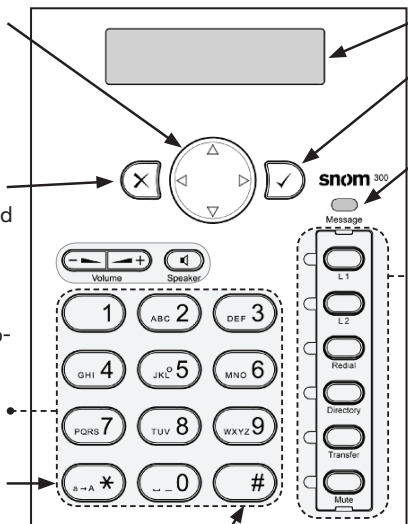

Display

Enter key

Confirming actions, selections, and input

MWI + missed calls

- Retrieve msg: ☑
- Turn off LED after missed call: ☑

Programmable function keys with LEDs

Default mappings:

- L1, L2: Line keys
- Redial: Redialing last number
- Phone directory
- Call transfer
- Mute microphone (on/off)

Pound key (hash key)

LEDs of line keys (L1, L2)

- Fast-blinking: Incoming call. Press key to accept call.
- Steady light: In call
- Slow-blinking: Call on hold

Administrator/user mode

The factory setting is administrator mode. The default administrator password is 0000 (4 x zero).

- Switch from administrator mode to user mode: Web interface > Advanced > Qos/ Security > Security > Administrator Mode: Off > Save.
- Switch from user mode to administrator mode: Web interface > Advanced > Administrator Login > enter administrator password > Save.

Settings menu

Press ▼ to open to top of list (Call Forwarding). Press ▼ ▲ to go to end of list (Information) from idle screen. Press x to return to the idle screen.

Call Forwarding
*off

Asterisk preceding an option: Currently active selection.

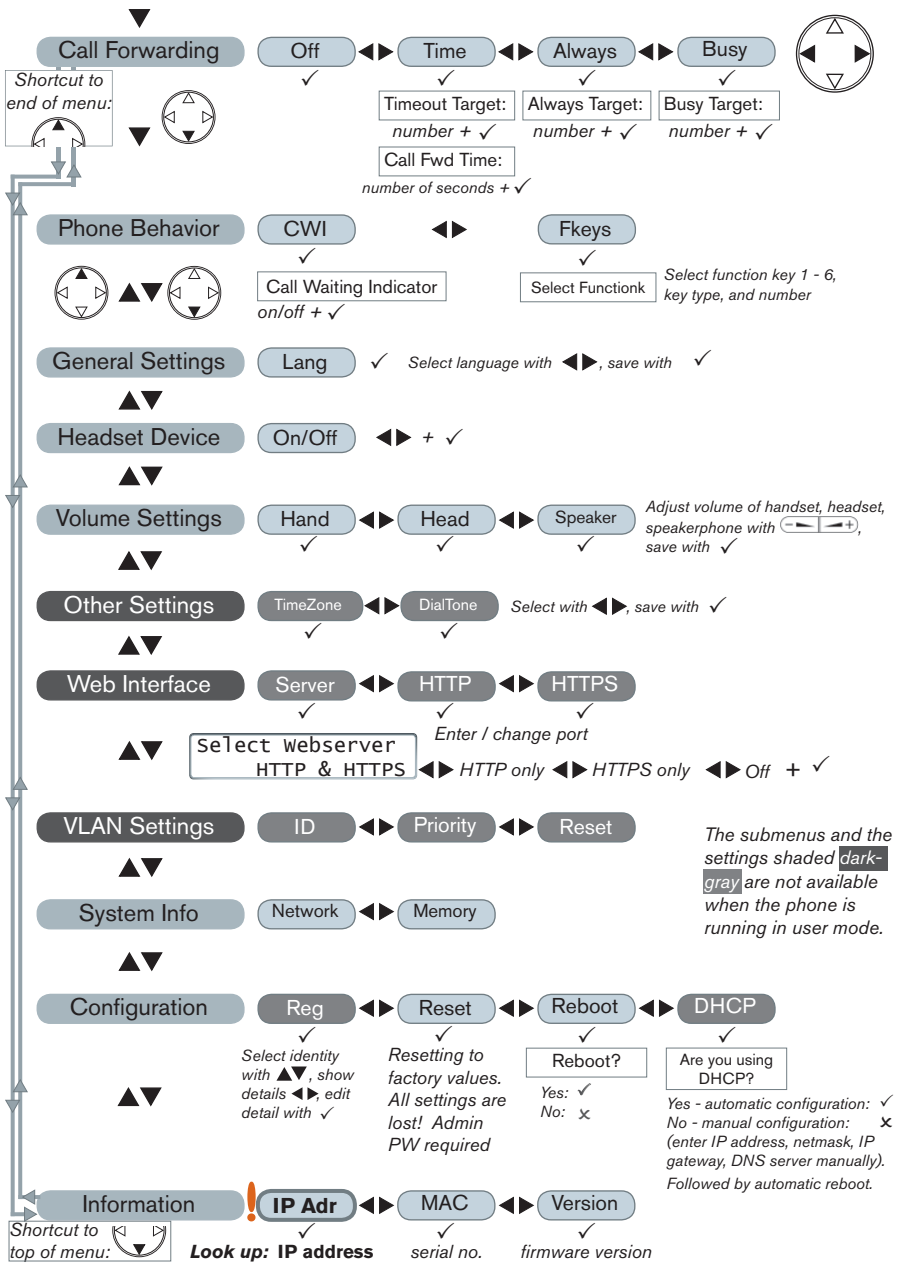

The phone's web interface

1. Look up the phone's IP address: ▼ ▲ ✓. Example: 192.168.10.115.
2. Open a web browser on your PC. Enter http:// and the IP address in the address bar and press ENTER. The "welcome" screen opens.
3. Click on an item in the menu on the left side of the screen to open that window.



4. If a window contains several pages, click on the tab at the top to open the page. The font weight of the characters on the tab of the visible page is **bold**.
5. Any changes you make will not take effect until you click on "Save". Changes will be lost if you open another page of the web interface without first clicking on "Save".

Clock/time format

Web interface > Preferences > General Information > 24 Hour Clock:

On: 24-hour format, 00:01 to 24:00

Off: 12-hour AM/PM format, 0:01 AM to 12:00 PM

Configuring & modifying identities

Web interface > Identity 1-4 >

Using the phone

Select outgoing identity

From the idle screen, press ◀▶ to select one of the configured identities.

Making calls

- Enter the number on the alphanumeric keypad and pick up the handset or
- pick up the handset, enter the number, ✓ or
- , enter the number, ✓

Speed Dial

Settings: Web interface > Speed Dial. Type each phone number with any necessary area code and/or country code etc. without spaces, hyphens, etc. into one of the textboxes of the table. One phone number per text box. Do not add any names or other data. Example: To enter (911) 555-1234, type 9115551234.



Speed dialing: Type the speed dial number or character on the alphanumeric keypad and press ✓.

Emergency Numbers

These numbers can be called even when the keyboard is locked. They must be set on the web interface.

Settings: Web interface > Preferences > Lock Keyboard > Emergency Numbers (space separated). Type each number without spaces, hyphens, etc. between the digits, separate the individual numbers with one empty space between them. Example: 911 115 986543. The numbers "911", "115", and "986543" can be dialed when the keyboard is locked.

Accepting calls

- With handset: Pick up the handset
- With a headset: Press  or blinking line key
- With the speakerphone: Press 

Putting calls on hold



Press the line key of the call. The LED starts to blink slowly. Press the key again to resume the call.

Calls on Hold: 1
 Jane Doe

Conference

1. Put first party on hold.
2. Call second party. With second party on line:

John Smith	0:10
Cnf.On	
3. Press ✓ to start conference. In conference:

Jane Doe	1:20
Cnf.off	 
4. Press ✓ to stop conference and put both parties on hold.

Calls on Hold: 2
 John Smith
5. Resume conference: Press line key for one of the parties, then ✓.

Call transfer

Attended transfer

Put the call on hold > Dial the number that you wish to transfer the call to > If the third party wishes to accept the call, press the Transfer key.



Blind transfer

With the call on the line, press the Transfer key, then dial the phone number the call is to be transferred to and press ✓.

Call forwarding

- Turn call forwarding on.
 - All incoming calls: ▼ Call forwarding > ►► Always > ✓ Always target > enter phone number of forwarding target > ✓.
 - When busy: ▼ Call forwarding > ◀ Busy > ✓ Busy target > enter phone number > ✓.
 - When call is not picked up: ▼ Call forwarding > ► Time > ✓ Timeout target > enter phone number > enter number of seconds after which call will be forwarded > ✓.
 - The idle display when call forwarding is turned on:

156	16:05
CFwd	
- Turn call forwarding off: ▼ > Off > ✓.

Call lists

- From the idle screen, press ▲ to open.
- Select list of missed, received, dialed calls with ◀► and ✓.
- Scroll through list with ▲▼.

Directory

- Opening list of names: Press  Directory
- Scroll with ▲▼. Shortcut to <New Item> at the end of the list: ▲.
- Dial ◀► Details ◀► Edit ◀► Clear. Select with ✓.

John Smith	Dial
------------	------

Trouble shooting

Reboot

Press ▼▲▲ Configuration ►► Reboot > "Reboot?" > ✓

Hard reboot

Disconnect power, wait for a few seconds, reconnect.

Never disconnect the power during a firmware update!

Reset to factory values

▼▲▲ Configuration ► Reset > enter administrator password > ✓

All customized settings will be lost!

Diese Kurzanleitung beschreibt die Installation, Einrichtung und den Betrieb des snom 300. Weitere Informationen finden Sie auf unserer Webseite, <http://wiki.snom.com/Snom300>.

Copyright, Markenrechte, GNU Lizenz, Haftung

© 2010 snom technology Aktiengesellschaft
Alle Rechte reserviert.

snom sowie die Namen der snom-Produkte und die snom logos sind gesetzlich geschützte Marken der snom technology AG. Alle anderen Produkt- und Firmennamen sind Marken der jeweiligen Inhaber.

snom technology AG behält sich jederzeit das Recht auf Überarbeitung und Änderung dieses Dokumentes vor, ohne verpflichtet zu sein, die vorgenommenen Änderungen anzukündigen oder mitzuteilen.

Texte, Bilder, Grafiken und deren Anordnung in diesem Dokument unterliegen weltweit dem Schutz des Urheberrechts und anderen Schutzgesetzen. Ihre Verwendung, Reproduktion oder Weitergabe ohne ausdrückliche schriftliche Zustimmung der snom technology AG können sowohl straf- als auch zivilrechtlich verfolgt werden.

Trotz der angewandten Sorgfalt bei der Zusammenstellung und Präsentation der Informationen in diesem Dokument können sich Daten zwischenzeitlich geändert haben. Daher übernimmt snom keine Gewähr für die Richtigkeit, Vollständigkeit oder Aktualität der zur Verfügung gestellten Informationen. Jegliche Haftung für Schäden ist ausgeschlossen, sofern diese nicht auf Vorsatz oder grober Fahrlässigkeit auf seiten von snom beruhen oder sofern keine Haftung aufgrund zwingender gesetzlicher Bestimmungen eintritt.

Unsere Firmware enthält teilweise Quellcodes, die unter der GNU Public License (GPL) von jedermann genutzt und modifiziert werden dürfen, solange sie wiederum mit denselben Lizenzbedingungen zur allgemeinen Nutzung veröffentlicht werden. Die Quellcodes der von snom genutzten und der GPL unterliegenden Komponenten können Sie auf der Supportseite unserer Webseite auf www.snom.com, den Wortlaut der GPL auf <http://www.snom.com/de/support/download/gpl-quellcode/> herunterladen.

Wichtige Hinweise

Lesen Sie bitte vor Inbetriebnahme die Sicherheitshinweise und die Bedienungsanleitung. Lassen Sie sie auch von den Mitbenutzern des Gerätes lesen oder informieren Sie sie über deren Inhalt. Bewahren Sie diese Bedienungsanleitung auf und geben Sie das Telefon nur mit der Bedienungsanleitung an Dritte weiter..

Sicherheit

Befolgen Sie die Anweisungen in dieser Bedienungsanleitung und in der sonstigen Dokumentation des Geräts.

- Falls die Stromversorgung nicht über ein Ethernetkabel erfolgt, verwenden Sie nur das mitgelieferte Netzteil. Die Verwendung anderer Netzteile könnte das Telefon beschädigen oder gar zerstören.

- Vermeiden Sie es, die Netz- und Stromkabel so zu verlegen, dass sie durch mechanischen Druck beschädigt werden oder dass Personen darüber stolpern könnten.
- Dieses Gerät ist nur für den Gebrauch in Innenräumen bestimmt - NICHT FÜR DEN AUSSENBEREICH!
- Stellen Sie das Telefon nicht in Räumen mit hoher Luftfeuchtigkeit wie z.B. Badezimmern, Waschküchen, feuchten Kellerräumen auf. Tauchen Sie das Telefon nicht in Wasser und gießen Sie keine Flüssigkeiten auf oder in das Gerät.
- Stellen Sie das Telefon nicht in explosionsgefährdeten Umgebungen (z.B. Lackierereien) auf. Benutzen Sie das Telefon nicht, wenn Sie Gas oder andere möglicherweise explosionsgefährliche Dämpfe riechen.
- Telefonieren Sie nicht während eines Gewitters (Stromschlaggefahr bei Blitzeinschlag ins Netz).

SELV (Safety Extra Low Voltage) Einhaltung

Die Eingangs-/Ausgangsverbindungen halten die SELV-Richtlinien für Kleinspannungsgeräte ein.

Warnung: Um elektrische Schläge zu vermeiden, verbinden Sie keine SELV-Geräte mit Geräten, die Telefon-/Netzwerk-Spannung (TNV) führen. Nur an LAN-Ports anschließen!

Normkonformität

Dieses Gerät ist CE- und FCC-geprüft und entspricht den geltenden europäischen und US-amerikanischen Richtlinien.



Die eigenmächtige Öffnung des Geräts sowie Änderungen und Modifizierungen am Gerät führen zum Erlöschen der Gewährleistungspflicht und können darüberhinaus zum Erlöschen der Zulassungen führen. Wenden Sie sich bei Betriebsstörungen oder Defekten an autorisiertes Servicepersonal, an Ihren Verkäufer oder an snom.

- **Sicherheit:** IEC 60950-1:2001, CB Test-Zertifikat: DE 2-013297
- **Zertifikate:** FCC Class B, CE Mark
- **Stromspeisung:** Über Netzwerk (PoE, IEEE 802.3af, Klasse 1) oder Netzteil 5V DC
- **Leistungsaufnahme:** 1,7 – 2,7 Watt
- **1 x LAN, 1 x PC:** RJ45 (Ethernet)
- **Ethernet:** 2x IEEE 802.3 10/100 Mbps switch

Reinigung

Benutzen Sie ein antistatisches Tuch. Benutzen Sie kein Wasser und keine Reinigungsflüssigkeiten, da sie die Oberfläche und die Elektronik des Gerätes beschädigen könnten.

Entsorgung des Produkts



Dieses Gerät unterliegt der europäischen Richtlinie 2002/96/EG und darf nicht im Hausmüll entsorgt werden.



Wenn Sie nicht wissen, wo Sie Ihr Altgerät entsorgen können, wenden Sie sich bitte an Ihre Kommune, Ihren örtlichen Müllentsorger oder Ihren Fachhändler.

Initialisierung und Registrierung des Telefons

Beachten Sie bitte: Sie benötigen die von Ihrem Netzwerkadministrator oder Ihrem VoIP-Provider erhaltenen Zugangsdaten für die Registrierung und Nutzung Ihres Accounts (Kontos), normalerweise Telefonnummer, Passwort und Registrar.

Sobald Sie das Telefon - wie auf den Seiten 2-5 gezeigt - an das Netzwerk angeschlossen haben, beginnt es mit der Initialisierung und Registrierung.

Die Initialisierung erfolgt normalerweise automatisch über DHCP. Falls Ihr Netzwerk DHCP nicht unterstützt, benötigen Sie außerdem die IP-Adresse, den IP-Gateway und den DNS Server, die Sie ebenfalls von Ihrem Netzwerkadministrator oder VoIP-Provider erhalten, um sie manuell einzugeben, wenn Sie auf dem Display dazu aufgefordert werden.

Treffen Sie bei Aufforderung auf dem Display Ihre Auswahl mit  und speichern Sie mit .

1. Sprache. Die Einstellung ab Werk ist Englisch. Andere Sprachen stehen zur Verfügung, wenn Ihr Telefon/Netzwerk bei der Initialisierung mit dem Internet verbunden ist, so dass sie automatisch vom snom-Server heruntergeladen werden können (Firmware 7 und höher).
2. Rufton
3. Zeitzone
4. Geben Sie die Account/Telefon-Nummer ein. ✓
5. Geben Sie den Registrar ein > ✓. Bei erfolgreicher Anmeldung sehen Sie jetzt den Ruhebildschirm:

Account → 156 16:05 ← Zeit
 ← Derzeitige Einstellung: Audioaus-leingabe

Zahlen, Buchstaben und Sonderzeichen eingeben

Der aktuelle Eingabemodus wird auf dem Display mit "123" (Ziffern), "abc" (Kleinbuchstaben), "ABC" (Großbuchstaben) angegeben.

▼	Eingabemodus ändern	▲	Zeichen links vom Cursor löschen
◀	Cursor nach links bewegen	▶	Cursor nach rechts bewegen

Eingabe von Sonderzeichen in den Eingabemodi Klein- u. Großbuchstaben: Taste "1" schnell drücken, mit einer Pause nach jedem Zeichen. Beispiele:

1x = "." 2x = "+" 3x = "@" 4x = "1" 5x = ":"

Auf einen Blick

Navigationstaste

Navigieren in Menüs und Listen. Vom Ruhebildschirm:

- Anruflisten: ▲
- Menü Einstellungen: ▼

Beenden-Taste

Vorgänge und Eingaben beenden/löschen

Audiotasten

- Lautstärkeregelung
- Gehäuselautsprecher ein/aus

Alphanumerische Tastatur

Sternchentaste

- Im Editiermodus kurz gedrückt:
Wechseln zwischen Groß- + Kleinschreibung
- Einige Sekunden drücken:
Tastatur sperren/entsperren

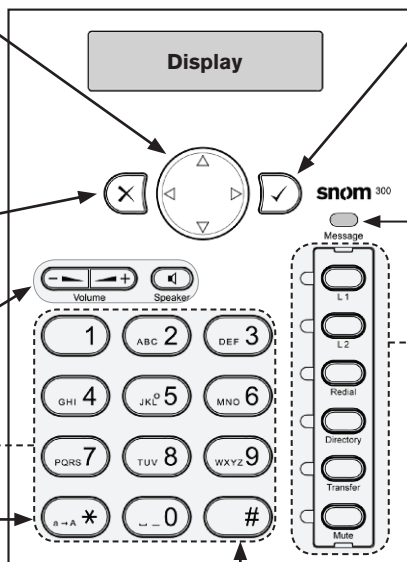

Eingabetaste

Aktion, Auswahl, Eingabe bestätigen

LED-Anzeige für wartende Nachricht + verpassten Anruf

- Nachricht abspielen:
- LED ausschalten nach verpasstem Anruf:

Programmierbare Funktionstasten mit LEDs

Einstellung ab Werk:

- L1, L2: Leitungen
- Redial: Erneut wählen
- Directory: Telefonbuch
- Transfer: Anruf weiterleiten
- Mute: Mikrophon ein/aus

LEDs der Leitungstasten (L1, L2)

- Schnell blinkend: Eingehender Anruf
- Leuchtet ohne Blinken: Im Gespräch
- Langsam blinkend: Gehaltener Anruf

Administrator- und Benutzermodus

Die Einstellung ab Werk ist Administratormodus. Das werkseitig eingestellte Administrator-Kennwort lautet: 0000 (4 x Null).

- Vom Administrator- in den Benutzermodus wechseln: Webbrowser des Telefons > Erweitert > Qos Sicherheit > Sicherheit > Administratormodus: Aus > Speichern
- Vom Benutzer- in den Administratormodus wechseln: Webbrowser des Telefons > Erweitert > Administratorlogin: Administratorkennwort eingeben > Speichern

Telefonmenü Einstellungen

Bei angezeigtem Ruhebildschirm: Den ersten Eintrag des Menüs (Umleitung) öffnen mit ▼, zum letzten Eintrag (Information) mit ▼▲. Im Menü drücken Sie auf x, um zur vorherigen Anzeige bzw. zum Ruhebildschirm zurückzukehren.

Umleitung bei

*Aus

* Vorangestelltes Sternchen: Zur Zeit aktive Auswahl.

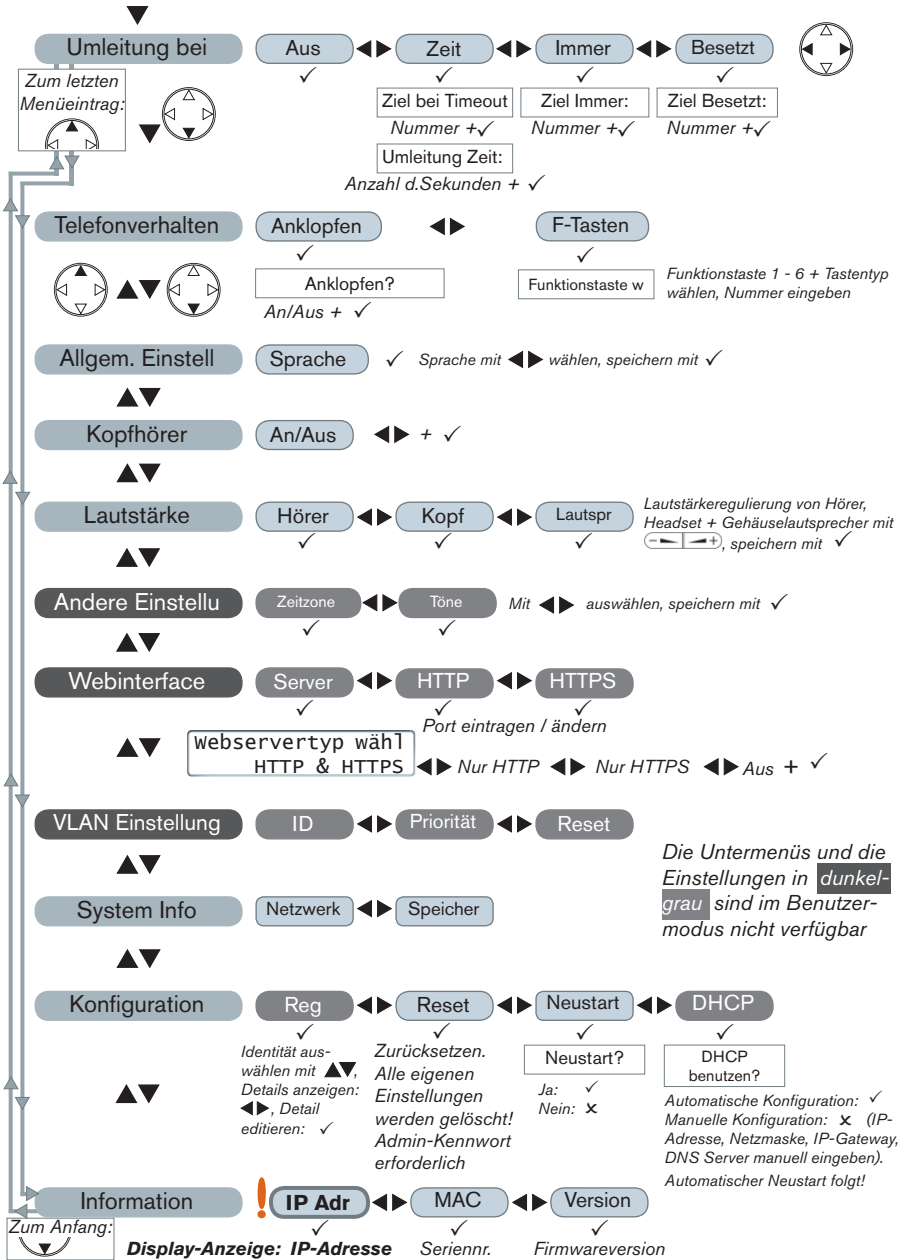

Der Webbrowser des Telefons

1. Zeigen Sie im Display die IP-Adresse mit ▼ ▲ ↻ an, z.B. 192.168.10.115.
2. Öffnen Sie den Webbrowser Ihres PCs, tippen Sie http:// und die IP-Adresse in die Adresszeile und drücken Sie auf die Bestätigen-Taste, um auf die Startseite des Telefon-Webrowsers zu gelangen.
3. Klicken Sie auf einen Menüpunkt auf der linken Seite, um das dazugehörige Fenster zu öffnen, z.B. Präferenzen.



4. Enthält das Fenster mehrere Seiten, klicken Sie auf einen Tab ("Karteireiter") am oberen Rand, um die Seite sichtbar zu machen. Der Schriftschnitt der Textzeichen auf der sichtbaren Seite ist **fett**.
5. Vor dem Schließen des Telefonbrowsers oder dem Anklicken eines anderen Menüpunktes immer auf "Speichern" klicken, wenn die vorgenommenen Änderungen wirksam werden sollen.

Zeitformat

Webbrowser > Präferenzen > Allgemeine Informationen > 24-Stundenuhr:

An: 24-Stundenformat, 00:01 - 24:00

Aus: 12-Stundenformat AM/PM, 0:01 A to 12:00 P

Identitäts-/Kontoeinstellungen

Webbrowser > Identität 1-4

Die Bedienung des Telefons

Identität für ausgehende Anrufe wählen

Vom Ruhebildschirm mit ◀ ▶ eine der konfigurierten Identitäten auswählen.

Anrufen

Nummer auf der alphanumerischen Tastatur eingeben und Hörer abheben oder

- Hörer abheben, Nummer eingeben, ✓ oder
- , Nummer eingeben, ✓.

Kurzwahl

Einstellung: Webbrowser > Kurzwahl. Geben Sie pro Textfeld eine Telefonnummer einschließlich der notwendigen Vorwahl/en ohne Leerstellen, Bindestriche usw. ein.

DEUTSCH

Fügen Sie keine Namen oder sonstigen Angaben hinzu. Beispiel: Die Telefonnummer (030) 555-1234 geben Sie so ein: 0305551234.



Anwendung der Kurzwahl: Geben Sie die Kurzwahlnummer oder das Kurzwahlzeichen auf der alfanumerischen Tastatur ein und drücken Sie ✓.

Notfallnummern

können auch dann angerufen werden, wenn die Tastatur verriegelt. Sie müssen im Webbrowser des Telefons hinterlegt werden.

Einstellung: Webbrowser > Präferenzen > Tastatursperre > Notrufnummern (Leerzeichen-getrennt). Geben Sie jede Telefonnummer ohne Leerstellen, Bindestriche usw. innerhalb der Nummer ein, mit einer Leerstelle zwischen den einzelnen Telefonnummern. Eingabebeispiel: 911 115 986543. Die Nummern "911", "115" und "986543" können jetzt selbst bei verriegelter Tastatur angerufen werden.

Anrufe annehmen

- Mit dem Hörer: Hörer abheben
- Mit einem Headset:  oder blinkende Leitungstaste drücken
- Mit dem Gehäuselautsprecher/-mikrofon:  drücken.

Anruf auf Halten setzen

Leitungstaste drücken. Die LED beginnt, langsam zu blinken. Anruf wiederaufnehmen: Taste erneut drücken.

Gehalten: 1
 Jane Doe

Konferenz (3-er)

1. Ersten Anrufer auf Halten setzen.
2. Zweiten Teilnehmer anrufen. Mit dem zweiten Teilnehmer in der Leitung:

John Smith	0:10
Knf. An	
3. Konferenz starten: ✓. Während der Konferenz:

Jane Doe	1:20
Knf. Aus	
4. Mit ✓ die Konferenz stoppen und beide Teilnehmer auf Halten setzen:

Gehalten: 2
 John Smith
5. Konferenz erneut starten: Leitungstaste eines Teilnehmers drücken, dann ✓.

Anruf-Weiterleitung

Mit Ankündigung

Anruf auf Halten setzen. Telefonnummer wählen, an die weitergeleitet werden soll. Will der Teilnehmer den Anruf entgegennehmen: Transfer-Taste drücken.



Ohne Ankündigung

Mit dem Anruf in der Leitung die Transfer-Taste drücken, Telefonnummer wählen, ✓.

Rufumleitung

Ruhebildschirm bei eingeschalteter Rufumleitung:



1. Rufumleitung einschalten.

- Alle eingehenden Anrufe: ▼ Umleitung > ►► Immer > ✓ > Ziel Immer > Telefonnummer eingeben > ✓.
- Bei Besetzt: ▼ Umleitung > ◀ Besetzt > ✓ Ziel Besetzt > Telefonnummer eingeben > ✓.
- Wenn der Anruf nicht angenommen wird: ▼ Umleitung > ► Zeit > ✓ > Ziel bei Timeout > Telefonnummer eingeben > Umleitung Zeit > Anzahl der Sekunden, nach deren Verstreichen umgeleitet wird, eingeben > ✓.

2. Rufumleitung ausschalten: ▼ Umleitung > Aus > ✓.

Anruflisten

1. Aufrufen vom Ruhebildschirm: ▲.

2. Liste der verpassten, angenommenen oder gewählten Anrufe auswählen: ◀►✓

3. Listeneintrag suchen: ▲▼.

Telefonbuch

- Öffnen:  Directory
- Scrollen: ▲▼. Direkt zu <Neuer Eintrag> am Ende der Liste: ▲.
- Wähle ◀► Details ◀► Ändern ◀► Löschen

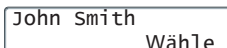

Fehlerbehebung

Neustart (Reboot)

▼▲▲ Konfiguration ►► Neustart > "Neustart?" > ✓

Harter Neustart

Netzstecker ziehen. Telefon nach ein paar Sekunden wieder anschließen.

Nie während eines Firmware-Updates die Stromzufuhr unterbrechen!

Werte zurücksetzen

▼▲▲ Konfiguration ► Reset > Administrator-Kennwort eingeben > ✓

Alle persönlichen Einstellungen werden gelöscht!

FRANÇAIS

Ce manuel abrégé décrit l'installation, l'initialisation et la mise en service du snom 300. Consultez notre site web pour des informations complémentaires:

<http://wiki.snom.com/Snom300>.

Copyright, Marques Déposées, GPL, Non Responsabilité

© 2009 snom technology Aktiengesellschaft

Tous droits réservés.

snom, les noms des produits snom et les logos snom sont des marques déposées par snom technology AG. Tous les autres noms de produits et noms d'entreprises sont les propriétés de leurs détenteurs respectifs.

snom technology AG se réserve le droit de modifier et de changer ce document à n'importe quel moment, sans devoir annoncer de telles modifications ou changements avant ou après leur mise en place.

Les textes, images et illustrations ainsi que leur mise en page dans ce document sont protégés par les copyrights et autres dispositions légales internationales. Leur utilisation, leur reproduction et leur transmission à des parties tierces sans accord express écrit peut induire des poursuites devant les cours criminelles et civiles.

Bien que le plus grand soin ait été apporté à la compilation et à la présentation des informations contenues dans ce document, les données sur lesquelles elles sont basées peuvent entre-temps avoir été modifiées. snom doit donc décliner toute garantie et toute responsabilité quand à l'exactitude et à l'exhaustivité des informations publiées excepté en cas de négligence flagrante de la part de snom ainsi que des les cas où la responsabilité de snom est engagée de par la loi.

Notre firmware inclus des éléments de code source qui peuvent être utilisés et modifié par quiconque selon les termes des licences GPL (cf. page 110), à condition qu'à leurs tours ils les rendent disponibles selon les mêmes termes. Veuillez vous rendre sur <http://www.snom.com/de/support/download/gpl-quellcode/> pour consulter la licence GPL originelle et le code source des composants couverts par la licence GPL qui sont utilisé dans les produits snom.

Informations importantes

Veillez lire les informations concernant la sécurité et la mise au rebut de l'appareil ainsi que celles concernant son installation et son utilisation avant d'utiliser l'appareil. Communiquez également ces informations aux autres utilisateurs ou faites-les leur lire. Conservez ce manuel et ne cédez pas l'appareil à une tierce partie sans y joindre le manuel.

Sécurité

Suivez les instructions présentes dans ce manuel et dans les autres documents concernant l'appareil.

- Evitez de placer le câble d'alimentation de l'appareil dans un endroit où il est possible de trébucher dessus. Evitez également de le placer là où il pourrait être exposé à un écrasement car il pourrait en être endommagé. Si le cordon

d'alimentation ou la fiche sont endommagés, débranchez l'appareil et contactez du personnel d'entretien qualifié.

- Cet appareil est destiné à une utilisation en intérieur uniquement! **Ne l'installez pas au dehors!**
- N'installez pas l'appareil dans des pièces très humides (par exemple, dans une salle de bain, une buanderie ou un sous-sol humide). N'immergez pas l'appareil dans l'eau et ne versez pas de liquides d'aucune sorte sur ou dans l'appareil.
- N'installez pas l'appareil dans un lieu présentant un risque d'explosion (un magasin de peinture par exemple). N'utilisez pas l'appareil si vous sentez une odeur de gaz ou d'autres émanations potentiellement explosives.
- N'utilisez pas l'appareil durant les orages, le choc d'un éclair sur les circuits électriques peut provoquer une électrocution.

Conforme à SELV (Safety Extra Low Voltage) - TBTS (Très Basse Tension de Sécurité)

Le niveau de sécurité des connexions d'entré/sortie est conforme aux recommandations SELV /TBTS.

Avertissement : Pour éviter les électrocutions, ne connectez pas les circuits de SELV / TBTS aux circuits sous tension du réseau téléphonique (TNV). Ne connectez le câble NET/Ethernet qu'à un port LAN!

Conformité au standards

Cet appareil est certifié CE et FCC et répond aux standards environnementaux, de sécurité et de santé européens et américains.



L'ouverture, la modification ou le remplacement sans autorisation de l'appareil annule la garantie et peut également annuler les certifications CE et FCC. En cas de mauvais fonctionnement, veuillez contacter le personnel d'entretien agréé, votre revendeur ou bien snom.

- **Sécurité:** IEC 60950-1:2001, Certificat CB Test: DE 2-013297
- **Certificat:** FCC Class B, CE Mark
- **Consommation d'énergie:** 1,7 – 2,7 Watts
- **Alimentation:** Par transformation 5 V DC ou PoE (Power over Ethernet[®]) IEEE 802.3af, Classe 1
- **1 x LAN, 1 x PC:** RJ45 (Ethernet) ▪ **Ethernet:** 2x IEEE 802.3 10/100 Mbps switch

Mise au Rébut du Produit



Cet appareil est soumis à la Directive 2002/96/CE et ne peut être mis au rebut avec les déchets ménagers normaux.

Si vous ne savez pas où mettre au rebut ou faire recycler l'appareil lorsqu'il arrive au terme de son existence, contactez votre municipalité, la société locale en charge de la gestion des déchets ou votre vendeur.

Nettoyage



Utilisez un tissu antistatique. N'utilisez pas de l'eau ou un produit de nettoyage liquide ou solide. Ils peuvent endommager l'électronique ou les surfaces de l'appareil.

Initialisation et enrégistration

Renseignement: Vous devez également disposer des données pour la registration et l'utilisation de votre compte que vous avez reçu de votre administrateur réseau ou de votre fournisseur de VoIP, normalement la numéro de téléphone, le mot de passe et le régistraire.

Une fois que l'appareil est connecté avec le réseau comme indiqué sur les pages 2-5, il commence à s'initialiser et se registrer.

L'initialisation est normalement fait automatiquement via DHCP. Si votre réseau ne supporte pas le protocole DHCP, vous devez également saisir l'adresse IP, la passerelle IP et le serveur DNS manuellement. Demandez-les de votre administrateur réseau ou de votre fournisseur de VoIP et suivez les instruction qui s'affichent à l'écran.

Sélectionnez une option avec  et sauvegardez chaque sélection avec .

1. Langue. Le paramètre par défaut est Anglais. D'autres langues sont disponibles si votre téléphone est connecté à l'internet lors de l'initialisation. Dans ce cas ils sont téléchargés à partir du serveur snom (Firmware 7 et supérieur).
2. Tonalité
3. Fuseau horaire
4. Saisissez votre numéro de téléphone/compte + appuyez sur ✓
5. Saisissez votre registraire + ✓. Si l'enregistrement a réussi l'écran d'attente s'affiche:

Account → 156 16:05 ← L'heure
 ← Dispositif audio actuel

Saisie de lettres, chiffres et caractères spéciaux

Le mode de saisie actuel est indiqué par "123" (chiffres), "abc" (lettres minuscules), "ABC" (lettres majuscules).

▼	Changer le mode de saisie	▲	Supprimer la lettre à la gauche du curseur
◀	Déplacer le curseur vers la gauche	▶	Déplacer le curseur vers la droite

Saisie de caractères spéciaux en mode de saisie lettres: Appuyez rapidement plusieurs fois sur la touche "1", avec une petite pause après chaque caractère.

Exemples: 1x = "." 2x = "+" 3x = "@" 4x = "1" 5x = ":",

D'un seul coup d'oeil

Touche de navigation

au menus et listes. De l'écran d'attente:

- Listes des appels: ▲
- Menu Paramètres: ▼

Touche annulation

Annuler les actions
Effacer les saisies

Touches audio

- Réglage du volume
- Haut-parleur (mise en marche/arrêt)

Clavier alphanumérique

Touche astérisque

- Appuyé brièvement en mode de saisie: Passer entre mode majuscule et mode minuscule
- Appuyé pour quelques secondes: Verrouiller/déverrouiller le clavier

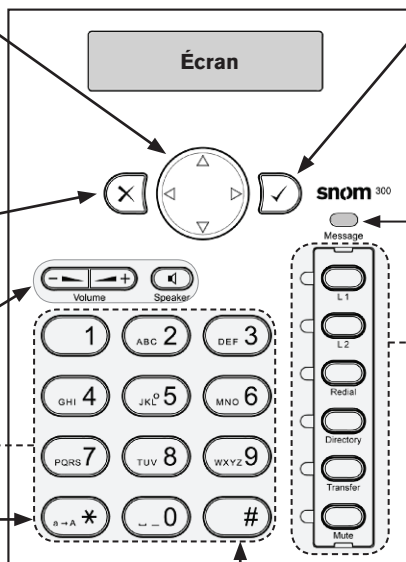

Touche dièse

Touche confirmation

Confirmer les actions, sélections, saisies

Diode - messages en attente + appels manqués

- Écouter les messages: ✓
- Éteindre la diode après un appel manqué: ✕

Touches de fonction (programmable) avec diodes

Réglage par défaut:

- L1, L2: Lignes externes
- Redial: Recomposer
- Directory: Annuaire
- Transfer: Transférer un appel
- Mute: Microphone (en marche/arrêt)

Les diodes des touches de ligne (L1, L2)

- Clignotant rapidement: Un appel sonne
- Allumé sans clignoter: Appel en cours
- Clignotant lentement: Appel en attente

Mode administrateur/mode utilisateur

La réglage par défaut est le mode administrateur. Le mot de passe administrateur par défaut est: 0000 (4 x zéro).

- Passer de mode administrateur en mode utilisateur: Interface web du téléphone > Avancés > Qos/Security > Sécurité > Mode Administrateur: Off > Sauvegarder
- Passer de mode utilisateur en mode administrateur: Interface web du téléphone > Avancés > Login Administrateur: Saisissez le mot de passe administrateur dans le champs de saisie > Sauvegarder.

Menu Paramètres

En mode inactif: Ouvrir le menu (premier sous-menu "Renvoi d'appel") avec ▼, aller directement au dernier sous-menu (Information) avec ▼ ▲. Appuyez sur ✕ pour çêñ retourner à l'écran préalable ou à l'écran d'attente.

Renvoi d'appel
*ARRET

* Astérisque antéposé: Sélection active en cours.

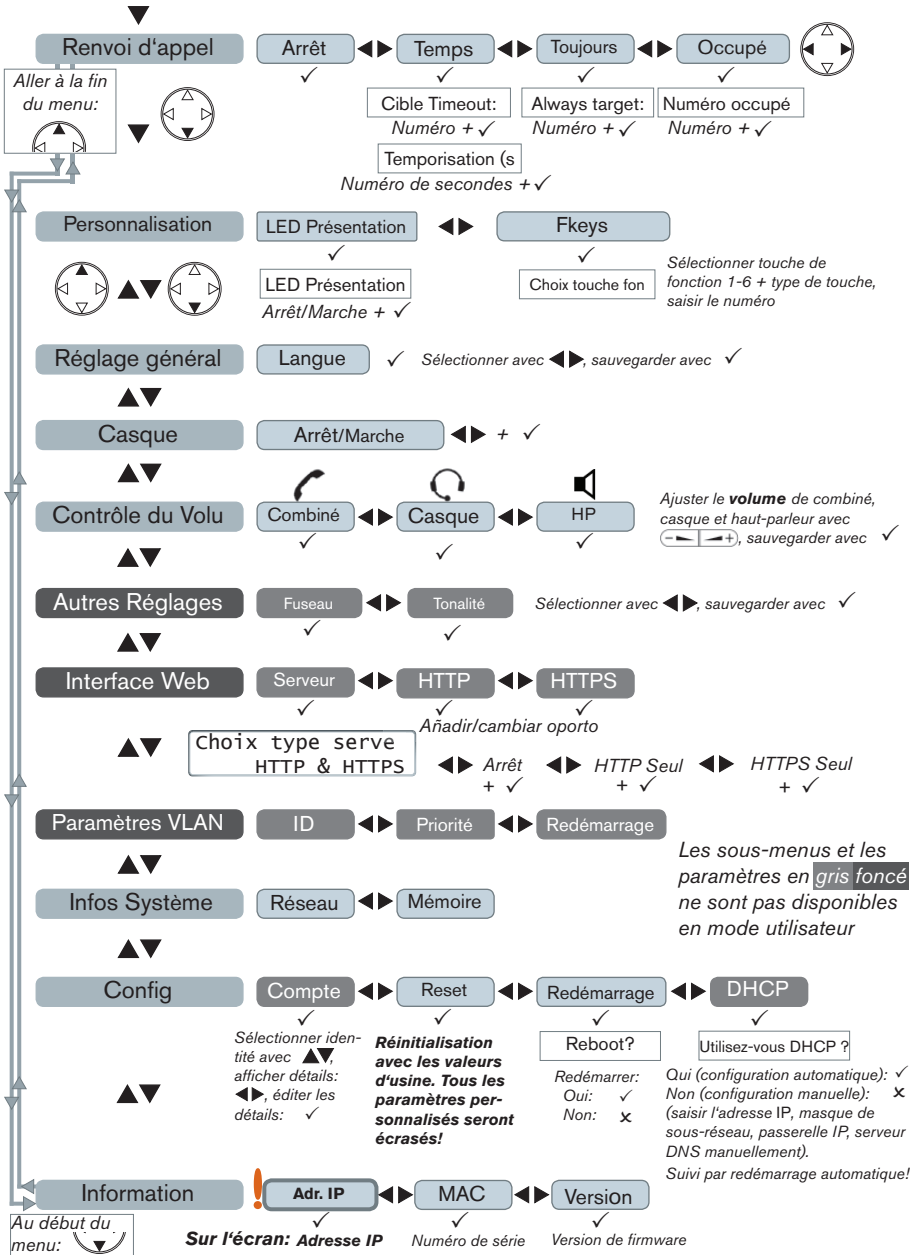

L'interface Web du téléphone

1. Obtenir l'adresse IP: ▼ ▲ ↻, p.ex. 192.168.10.115.
2. Ouvrez le navigateur web de votre PC et saisissez http:// suivi de l'adresse IP dans la barre d'adresse. Appuyez sur la touche d'entrée pour ouvrir la page d'accueil de l'interface Web du téléphone.
3. Cliquez sur un élément au menu à gauche pour ouvrir la page correspondante.



4. Certaines pages contiennent plusieurs documents. Pour rendre visible un document, cliquez sur l'onglet correspondant. Les lettres de l'onglet actif sont affichées en caractères **gras**.
5. Appuyez toujours sur la touche "Sauvegarder" avant de cliquer sur un menu différent ou de refermer l'interface Web si vous désirez appliquer les modifications que vous avez effectuées.

Format de l'heure

Interface Web > Préférences > Informations généraux > Horloge 24 Heures

On: Format 24 heures, 00:01 - 24:00

Off: Format 12 heures AM/PM, 0:01 A - 12:00 P

Paramètres d'identité/compte

Interface Web > Identité 1-4

Utiliser le téléphone

Sélectionner un identité pour l'appel sortant en course

de l'écran d'attente: ◀▶

Passer des appels

- Saisissez le numéro sur le clavier alphanumérique et décrochez le combiné ou
- Saisissez le combiné, saisissez le numéro et appuyez ✓ ou
- ◀, saisissez le numéro, ✓.

Composition Rapide

Configuration: Interface Web > Numérotation Rapide. Saisissez un numéro avec tous les préfixes requis dans la zone de texte au droit d'un numéro/caractère. N'AJOUTEZ PAS DE NOM AVANT OÙ APRES LE NUMÉRO!. Exemple: Saisissez le numéro

91.15.55.12.34 comme 9115551234.



Utilisation: Saisissez un numéro (0 - 30) ou les caractères spéciaux # ou * et appuyez sur ✓.

Numéros d'urgence

Ils peuvent être composés même lorsque le clavier est verrouillé! Ils doivent être enregistrés sur l'interface web du téléphone.

Configuration: Interface Web > Préférences > Verrouillage clavier > Emergency Numbers (space separated). Saisissez chaque numéro sans espace entre les chiffres, séparez les numéros par un espace vide. Exemple: 911 115 986543. Les numéros "911", "115" et "986543" peuvent être composés même si le clavier est verrouillé.

Accepter des appels

- Avec le combiné: Décrochez le combiné
- Avec un casque: Appuyez sur  ou la touche clignotante de la ligne
- Avec le haut-parleur/microphone du boîtier: Appuyez sur 

Placer un appel en attente

Appuyez sur la touche de la ligne. La diode commence à clignoter lentement. Reprendre l'appel: Appuyez sur la touche de la ligne encore un fois.

Appels en attent
Jane Doe

Conférence à trois

1. Mettez le premier appel en attente.
2. Appelez la deuxième partie. Avec le deuxième appel en ligne:



John Smith	0:10
Conf.Activ.	
3. Commencer la conférence: ✓. Conférence en cours:

Jane Doe	1:20
Conf.Inactiv.	
4. Arrêter a conférence et mettre les deux parties en attente: ✓.

Appels en attent
John Smith
5. Recommencer la conférence: Appuyez sur la touche de ligne d'un des deux parties, ✓.

Transfert d'un appel

Attendu

Mettre l'appel en attente > Composez le numéro de la tierce partie. 
Annoncez l'appel > Si la tierce partie veut l'accepter: Appuyez sur la touche  Transfer

Sans l'annoncer a la tierce partie:

Appuyez sur la touche Transfer avec l'appel en ligne, composez le numéro de la tierce partie, appuyez sur ✓.

Renvoi d'appel

1. Activer le renvoi d'appel.
 - a. Tous les appels entrants: ▼ Renvoi d'appel > ►► Toujours > ✓ > Always target > composez le numéro > ✓.
 - b. Sur occupation: ▼ Renvoi d'appel > ◀ Occupé > ✓ Numéro Occupée > composez le numéro > ✓.
 - c. Après un délai de réponse: ▼ Renvoi d'appel > ► Tempo > ✓ > Cible Timeout > composez le numéro > Temporisation (s > nombre de secondes après lequel l'appel est redirigé > ✓.
 - d. L'écran d'attente avec renvoi d'appel actif: 
2. Désactiver le renvoi d'appel: ▼ Renvoi d'appel > ARRET > ✓.

Listes des appels

1. Ouvrir les listes de l'écran d'attente: ▲.
2. Sélectionner la liste des appels manqués (perdu), recus, appelés: ◀► ✓
3. Chercher un appel dans une liste: ▲▼.

Annuaire du telephone



- Ouvrir: Appuyez sur la touche Directory
- Faire défiler: ▲▼. Aller directement à <Nouvelle Entrée>: ▲.
- Composer ◀► Détails ◀► Editer ◀► Effacer

John Smith
Composer

Dépannage

Redémarrage (Reboot)

▼▲▲ Config ►► Redémarrage > "Reboot?" > ✓

Redémarrage à froid

Retirez la prise de courant. Rebranchez l'alimentation après quelques secondes.

Ne coupez pas l'alimentation pendant une mise à jour du firmware !

Réinitialisation aux valeurs d'usine

▼▲▲ Config ► Reset > Saisissez le mot de passe administrateur > ✓

Tous les paramètres personnalisés seront écrasés!

ITALIANO

Questa è la guida rapida per l'installazione, l'impostazione e il funzionamento dello snom 300. Per ulteriori informazioni consultare la nostra pagina web:

<http://wiki.snom.com/Snom300>.

Copyright, Marchi registrati, GPL, Declinazione di responsabilità

© 2009 snom technology Aktiengesellschaft
Tutti i diritti riservati.

snom, i nomi dei prodotti snom, ed i loghi snom sono marchi registrati di proprietà di snom technology AG. Tutti gli altri nomi di prodotti e di imprese sono proprietà dei rispettivi proprietari.

snom technology AG si riserva il diritto di rivedere e modificare il presente documento in qualsiasi momento senza alcun obbligo di notifica precedente o posteriore a tali cambiamenti.

Testi, immagini ed illustrazioni ed il loro ordine in questo documento sono soggetti a protezione del diritto d'autore ed altri diritti legali a livello mondiale. Il loro utilizzo, riproduzione e trasmissione a terzi senza il permesso scritto di snom potrebbe dar luogo ad azioni legali, in sede penale e civile.

Sebbene sia stata prestata la massima attenzione nella stesura e presentazione delle informazioni in questo documento, i dati su cui si basa potrebbero già aver subito variazioni. snom pertanto declina ogni responsabilità riguardo a tutte le garanzie di affidabilità, accuratezza, completezza ed attualità delle informazioni pubblicate, tranne nel caso di grossolana negligenza da parte di snom o laddove per legge possa essere ritenuta responsabile.

Il nostro firmware include codice sorgente utilizzabile e modificabile da chiunque. La licenza pubblica GNU (GPL) (cfr. pag. 92), consente di rendere disponibile il software con lo stesso accordo di licenza. Visitate <http://www.snom.com/de/support/download/gpl-quellcode/> per la licenza GPL originale e per i codici di sorgente di componenti sotto licenza GPL ed utilizzati in prodotti snom.

Informazioni importanti

Pregasi leggere con attenzione le istruzioni inerenti la sicurezza, lo smaltimento e l'installazione del dispositivo prima del suo impiego. Tali informazioni vanno condivise con gli altri utenti. È altresì necessario conservare questo manuale, consegnandolo insieme al dispositivo qualora esso venga dato a terzi.

Sicurezza

Seguite le istruzioni in questo manuale e tutta la documentazione relativa al dispositivo.

- Utilizzate solo l'adattatore del dispositivo. Altri adattatori di corrente potrebbero danneggiare, anche irreversibilmente, il dispositivo soggetto a pressione meccanica ed il cavo. Se il cavo o la spina si danneggiano, scollegare il dispositivo e contattare il personale di assistenza qualificato.
- Non posizionare il cavo di corrente del telefono dove può essere calpestato.
Non posizionare il cavo di corrente del telefono dove può essere soggetto a

pressione meccanica perchè potrebbe danneggiare il cavo. Se il cavo o la spina si danneggiano, scollegare il telefono e contattare il personale di assistenza qualificato.

- Questo apparecchio si può impiegare solo al chiuso! **Non installare all'aperto!**
- Non installare il dispositivo in ambienti con alta umidità (ad es., in bagno, lavanderia, seminterrati umidi). Non immergere il dispositivo in acqua e non versarvi liquidi sopra
- Non installare il dispositivo nei pressi di locali a rischio esplosione (colorifici, ad es.). Non utilizzare il dispositivo se sentite odore di gas o di altra esalazione potenzialmente esplosiva.
- Non utilizzare il dispositivo durante i temporali. Qualora un fulmine colpisca la rete elettrica, è passibile di scossa.

Conforme al circuito SELV (bassissima tensione di sicurezza)

Il livello di sicurezza dei circuiti in ingresso / uscita è conforme alle raccomandazioni SELV.

Attenzione: Per evitare scosse elettriche non collegare i circuiti SELV a quelli della rete telefonica (TNV). Le porte LAN hanno circuiti SELV, le porte PSTN hanno circuiti TNV.

Conformità



Il dispositivo è certificato CE e FCC e risponde agli standard europei e statunitensi di salute, sicurezza ed ambientali.

Eventuali modifiche, cambiamenti e l'apertura non autorizzata del dispositivo invalidano la garanzia e potrebbero eventualmente annullare le certificazioni CE e FC. In caso di malfunzionamento contattare il personale di assistenza autorizzato, il rivenditore, o snom.

- **Sicurezza:** IEC 60950-1:2001, Certificato Test CB: DE 2-013297
- **Certificazioni:** FCC Class B, Marchio CE
- **Consumo di potenza:** 1,7 – 2,7 Watt
- **Potenza:** 5 V DC o PoE (Power over Ethernet) IEEE 802.3af, Class 1
- **1 x LAN, 1 x PC:** RJ45 (Ethernet)
- **Ethernet:** 2 interruttori IEEE 802.3 da 10/100 Mbps

Smaltimento del dispositivo



Questo dispositivo è soggetto alla Direttiva Europea 2002/96/EC e non può essere smaltito con i rifiuti domestici.

Se non sapete come smaltire l'apparecchio una volta inutilizzabile, contattate il comune, la nettezza urbana locale, o il vostro rivenditore.

Pulizia

Utilizzare un panno antistatico. Evitare acqua e altri liquidi o detersivi solidi che potrebbero danneggiare la superficie o l'elettronica interna.

Inizializzazione e registrazione

Nota: Sono necessarie le informazioni di registrazione ricevute dal fornitore di servizi internet o amministratore del sistema – generalmente numero di telefono o numero interno, password e registrar. .

Una volta impostato il telefono e averlo collegato alla rete come indicato alle pagine 2 - 5, il telefono avvia la procedura di inizializzazione.

Di norma la procedura di inizializzazione si svolge in maniera completamente automatica, mediante protocollo DHCP. Se la rete non supporta il protocollo DHCP, è necessario ottenere indirizzo IP, maschera di rete, gateway IP e server DNS dal fornitore di servizi internet o amministratore di rete, quindi inserirli manualmente quando viene richiesto sullo schermo.

Selezionare un'opzione con  e salvare ogni selezione con .

1. Lingua. La lingua di default è l'inglese. Se il telefono/rete sono collegati a internet durante la procedura di inizializzazione, sono disponibili altre lingue che possono essere fornite automaticamente dal server snom (firmware 7 e superiori).
2. Segnali di linee libera
3. Fuso orario
4. Digitare il tuo numero di conto/telefono + premere ✓
5. Digitare il registrar + ✓ . Se la registrazione è riuscita, il display visualizza la schermata inattivo:

Account → 156 16:05 ← Ora
 ← Dispositivo audio presente

Inserire lettere, numeri e caratteri speciali

La modalità di inserimento corrente è indicata da "123" (numeri), "abc" (lettere minuscole), "ABC" (lettere maiuscole).

▼	Cambiare la modalità	▲	Cancellare il carattere a sinistra del cursore
◀	Spostare il cursore a sinistra	▶	Spostare il cursore a destra

Inserire caratteri speciali - modalità lettere minuscole o maiuscole): Premere rapidamente il tasto "1" più volte, con una piccola pausa dopo ogni lettera.

Esempi: 1x = "." 2x = "+" 3x = "@" 4x = "1" 5x = ":",

In sintesi

Tasto di navigazione

nei menu e liste. Dalla display inattivo:

- Elenchi chiamate: ▲
- Menu Impostazioni: ▼

Tasto annulla

Annullare azioni
Eliminazione delle voci

Tasto audio

- Regolazioni del volume
- Vivavoce (attivare/spegnere)

Tasti alfanumerici

Tasto asterisco

- Premuto brevemente in modalità inserimento: Passare dalla modalità lettere minuscole e maiuscole
- Premuto per alcuni secondi: Bloccare/sbloccare la tastiera

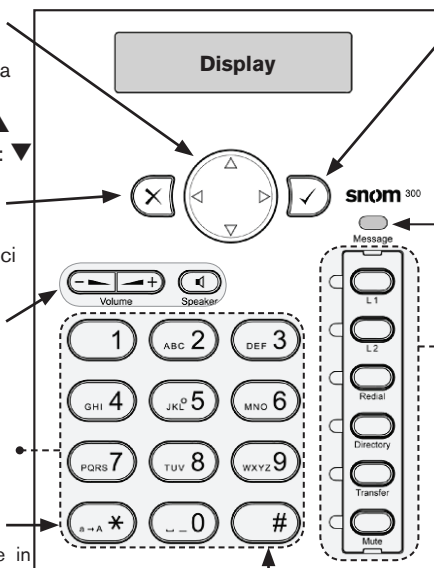

Tasto cancellato

Tasto di conferma

Confermare azioni, selezioni, ingressi

LED - messaggio in segreteria + chiamate perse

- Ascoltare le chiamate:
- Spegnerne il LED in caso di chiamate perse:

Tasti di funzioni (personalizzabili) con LED

- Impostazioni predefinite:
- L1, L2: Linee esterne
- Redial: Richiamo
- Directory: Rubrica
- Transfer: Trasferimento
- Mute: Attivare/disattivare il microfono

LED dei tasti di linea (L1, L2)

- Lampeggia rapidamente: Chiamata in arrivo
- Brillare senza lampeggia: Telefonata in corso
- Lampeggia lentamente: Chiamata attesa

Modalità utente/Modalità amministratore

L'impostazione di fabbrica è la modalità di amministratore. La password di default per l'amministratore è: 0000 (4 x zero). Cambiare la modalità:

- Tra modalità amministratore a modalità utente: Interfaccia web > Avanzate > QoS/ Security > Sicurezza > Mod. amministratore: Off > Salva
- Tra modalità utente a modalità amministratore: Interfaccia web > Avanzate > Login amministratore: Digitare la password di amministratore > Salva.

Menu Impostazioni

In modalità inattiva: Aprire il menu (primo sottomenu "Trasferisci Chiamate") con ▼, vai direttamente al sottomenu scorso (Informazioni) con ▼▲. Premere * per tornare alla schermata precedente o allo schermo inattivo.

Trasferisci Chia
*Spento

* Asterisco anteposto: Selezione attualmente attivo.

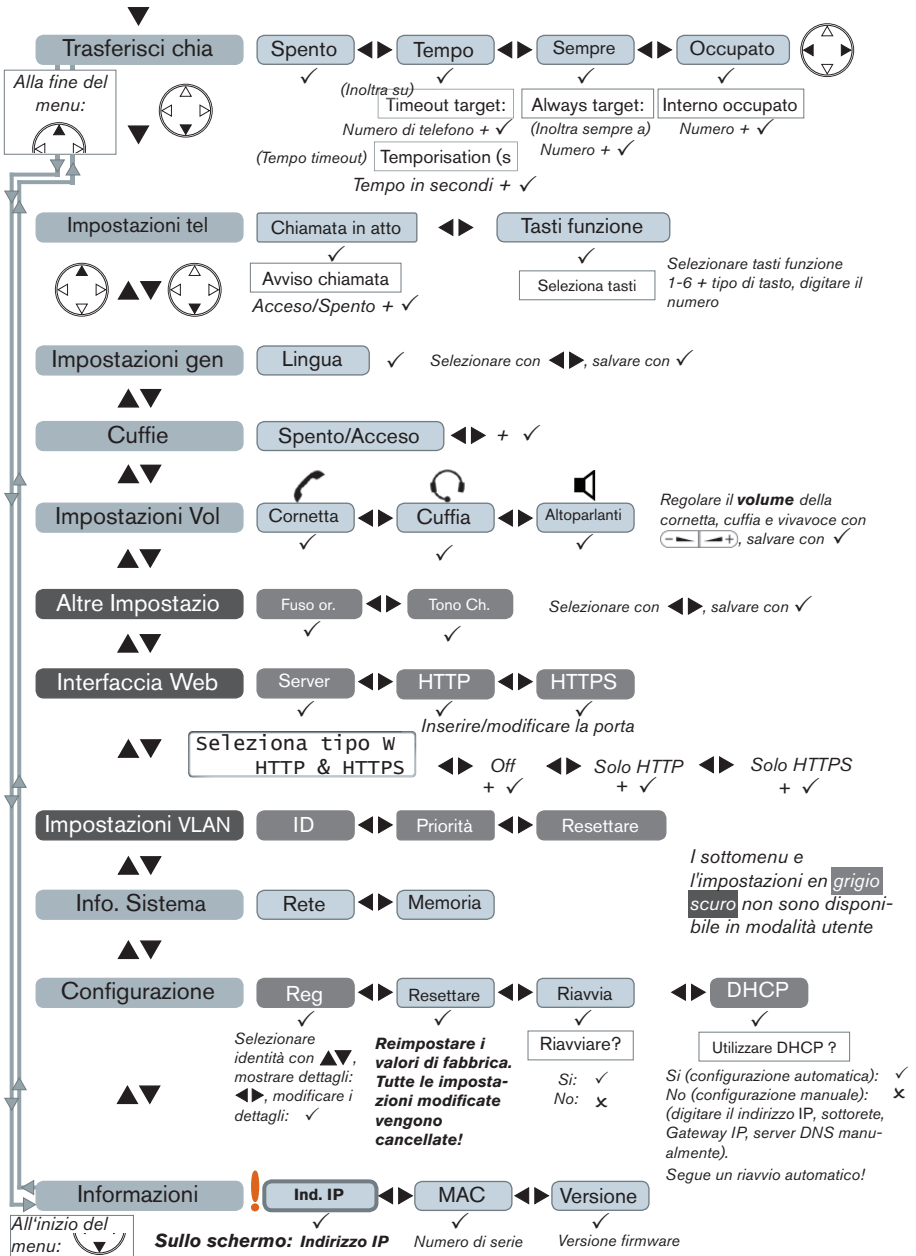

ITALIANO

L'interfaccia Web del telefono

1. Trovare l'indirizzo IP: ▼ ▲ ↻ , per esempio 192.168.10.115.
2. Aprire il browser web del vostro PC e digitare http:// seguito dall'indirizzo IP nella barra degli indirizzi. Premere Invio per aprire l'interfaccia Web del telefono.
3. Cliccare su una voce del menu per aprire la pagina relativa.



4. Alcune pagine contengono svariati documenti. Per rendere visibile un documento, cliccare sulla sua scheda. Il carattere è in **grassetto** per la scheda attiva.
5. Ricordare di premere sempre "Salva" prima di cliccare su un'altra voce del menu o di chiudere l'interfaccia web se volete che le modifiche vengano applicate.

Formato ora

Interfaccia Web > Preferenze > Informazioni generali > 24 Hour clock:
 On: Formato 24 ore, 00:01 - 24:00
 Off: Formato 12 ore AM/PM, 0:01 A - 12:00 P

Impostazioni identità/Account

Interfaccia Web > Identità 1-4

Usare il telefono

Selezionare un'identità per la chiamata in uscita in corso

dallo display inattivo: ◀▶

Chiamare

- Digitare il numero e sganciare la cornetta o
- Sganciare la cornetta, digitare il numero e premere ✓ o
- ◀, digitare il numero, ✓.

Speed Dial (composizione veloce dei numeri telefonici)

Impostazione: Interfaccia Web > Speed Dial. Inserire un numero di telefono completo di prefisso nel campo testo di un numero o carattere speciale. **NON AGGIUNGERE UN NOME PRIMA O DOPO IL NUMERO!** Esempio: Immettere il numero (911) 555-1234 come 9115551234.



Chiamare i numeri speed dial: Inserire il numero (0-30) o il carattere speciale # o * assegnato al numero di telefono e premere ✓.

Numeri di emergenza

Possono essere chiamati anche con la tastiera bloccata. Devono essere impostati in anticipo sull'interfaccia web.

Impostazione: Interfaccia Web > Preferenze > Blocca Keyboard > Numeri Emergenzy (spazio separato). Digitare ogni numero senza spazi tra le cifre, separare i vari numeri con uno spazio vuoto tra di loro. Esempio: 911 115 986543. I numeri "911", "115", e "986543" possono essere composto anche quando la tastiera è bloccata.

Accettare le chiamate

- Usando la cornetta: Sganciare la cornetta
- Usando una cuffia: Premere  o il tasto linea lampeggiante
- Usando il vivavoce: Premere 

Mettere le telefonate in corso in attesa

Premere il tasto linea. Il LED lampeggia lentamente.

Riprendere la chiamata: Premere nuovamente il tasto di linea.

Chiamate in atte
Jane Doe

Conferenza a tre

1. Mettere la prima chiamata in attesa.
2. Chiamare il secondo partecipante. Con la seconda chiamata sulla linea:

John Smith	0:10
Conf. Acceso	
3. Avviare la conferenza: ✓. Conferenza in corso:

Jane Doe	1:20
Conf. Spento	
4. Fermare la conferenza e mettere i partecipanti in attesa: ✓.

Chiamate in atte
John Smith
5. Avviare la conferenza di nuovo: Premere il tasto linea di uno dei partecipanti, ✓.

Trasferimento

Annunciato: Mettere le chiamata in attesa > Digitare il numero della terza persona. Annunciate la chiamata > Se il terzo desidera accettare la chiamata: Premere il tasto Transfer.



Trasferimento diretto (senza annunciare la chiamata): Con la chiamata sulla linea: Premere il tasto Transfer > digitare il numero della terza persona > premere ✓.

Inoltro di chiamate

1. Attivare l'inoltro di chiamate
 - a. Tutte le chiamate in arrivo: ▼ Trasferisci Chia > ►► Sempre > ✓ > Sempre interno > digitare il numero > ✓.

- b. Se occupato: ▼ Trasferisci Chia > ◀ Occupato > ✓ > Interno occupato > digitare il numero > ✓ .
 - c. Dopo timeout (senza risposta): ▼ Trasferisci Chia > ► Tempo > ✓ > Timeout Target > digitare il numero > Ora trasferiment > numero di secondi precedenti all'inoltro > ✓ .
 - d. Display inattivo con trasferimento autom. attivato: 
2. Disattivare: ▼ Trasferisci Chia > Spento > ✓ .

Gli elenchi chiamate

1. Per aprire: Premere ▲.
2. Selezionare un elenco (Lista chiamate: Perse, Entranti (in ingresso), (in) Uscenti) con: ◀►✓
3. Selezionare un numero di telefono dalla lista: ▲▼ .

Elenco del telefono



- Per aprire: Premere il tasto  Directory
- Per scorrere: ▲▼. Andare direttamente al <Nuovo inserimen>: ▲.
- Componi (chiamare il numero) ◀► Dettagli ◀► Modifica(re) ◀► Canc (eliminare)

John Smith
Componi

Risoluzione dei problemi

Riavvio (Reboot)

▼▲▲ Configurazione ►► Riavvia > ✓ > "Riavviare?" > ✓

Riavvio forzato

Staccare il telefono dalla presa di corrente. Ricollegare il telefono alla corrente dopo alcuni secondi.

Non staccare dalla corrente quando il telefono si sta riavviando !

Reimpostare i valori di fabbrica

▼▲▲ Configurazione ► Resettare > digitare il password amministratore > ✓

Tutte le impostazioni modificate andranno perse!

Esta es la Guía de inicio rápido para la instalación, configuración y uso del snom 300. Para más información, consulte el manual en nuestra página web <http://wiki.snom.com/Snom300>.

Propiedad intelectual, Marcas registradas, GNU General Public License, Exención de responsabilidad

© 2010 snom technology Aktiengesellschaft
Todos los derechos reservados.

snom, los nombres de los productos snom, y los logos de snom son marcas comerciales propiedad de snom technology AG. Los demás nombres de productos y empresas son propiedad de sus respectivos propietarios.

snom technology AG se reserva el derecho de revisar y modificar este documento en cualquier momento, sin obligación de notificar estas revisiones o modificaciones por adelantado o con posterioridad a su realización.

Los textos, imágenes e ilustraciones, y su presentación en este documento, están sujetos a la protección de copyright y otros derechos legales internacionales. Su uso, reproducción y transmisión a terceros sin permiso expreso por escrito puede dar lugar al inicio de procedimientos legales en los tribunales penales y civiles.

Aunque se han tomado todas las precauciones posibles en la compilación y presentación de la información de este documento, los datos en los que se basa pueden haber cambiado con el tiempo. snom, por lo tanto, renuncia a cualquier garantía y responsabilidad respecto a la precisión, exhaustividad y vigencia actual de la información publicada, excepto en el caso de intencionalidad o negligencia grave por parte de snom cuando se deriven responsabilidades de acuerdo con las disposiciones legales vinculantes.

Nuestro firmware incluye código fuente que puede ser usado y modificado por cualquier persona bajo la licencia pública GNU (GPL) (vease la página 55), siempre que, a su vez, lo ponga a disposición de cualquier otra persona que tenga el mismo acuerdo de licencia. Acceda a <http://www.snom.com/de/support/download/gpl-quellcode/> para obtener la licencia GPL original y el código fuente de los componentes con licencia en virtud de la GPL y utilizados en productos snom.

Información importante

Lea las instrucciones sobre seguridad telefónica y reciclaje del teléfono, y sobre cómo configurar y utilizar el teléfono antes de usarlo, y ofrézcalas igualmente a otros usuarios para que las lean o se informen de su contenido. Conserve este manual y no entregue el teléfono a terceros sin el mismo.

Seguridad

Siga las instrucciones de este manual y otra documentación aplicable del dispositivo.

- Si la alimentación del teléfono no se realiza mediante/por Ethernet, use exclusivamente el adaptador de alimentación entregado con el teléfono. Otros adaptadores de alimentación pueden dañar o incluso destruir el teléfono.

- Evite poner el cable de alimentación del teléfono de modo que otras personas puedan tropezar con el mismo. No coloque el cable de alimentación del teléfono de forma que pueda verse sometido a presiones mecánicas, ya que eso podría dañar el cable. Si el cable de alimentación o el enchufe están dañados, desconecte el teléfono y contacte con personal de servicio cualificado.
- Este dispositivo es **solamente para uso en interiores**. No debe instalarse en el exterior.
- No instale el teléfono en lugares con humedad elevada (por ejemplo, en baños, lavaderos, o sótanos húmedos). No sumerja el teléfono en agua ni derrame o vierta líquidos de ningún tipo sobre el teléfono.
- No instale el teléfono cerca de lugares con riesgo de explosión (talleres de pintura, por ejemplo). No use el teléfono si huele a gas o a otros vapores que puedan ser explosivos.
- No use el teléfono durante una tormenta; los rayos que impacten en la red eléctrica pueden provocar descargas eléctricas.

Cumplimiento de los requisitos SELV (Tensión Extra-Baja de Seguridad)

Las condiciones de seguridad de las conexiones de entrada/salida cumplen con los requisitos SELV.

Atención: Para evitar descargas eléctricas, no conecte circuitos de tensión extra baja (SELV) a circuitos de tensión de red telefónica (TNV). Los puertos LAN contienen circuitos SELV, los puertos PSTN contienen circuitos TNV. Algunos puertos LAN y PSTN utilizan conectores RJ-45 (8P8C). Tome precauciones cuando conecte los cables.

Cumplimiento con la normativa

Este teléfono tiene certificación CE y FCC, y cumple con los estándares de salud, seguridad y medioambientales europeos y de Estados Unidos.



La apertura, cambio, o modificación no autorizadas del teléfono provocarán la cancelación de la garantía, y también pueden causar la pérdida de las certificaciones CE y FCC. En caso de avería, contacte con personal de servicio autorizado, con su vendedor o con snom.

- **Seguridad:** IEC 60950-1:2001, Certificado de comprobación CB: DE 2-013297
- **Certificados:** FCC Class B, Indicación CE
- **Alimentación:** 5 V DC o PoE (Power over Ethernet) IEEE 802.3af, Clase 1
- **1 x LAN, 1 x PC:** RJ45 (Ethernet) ▪ **Consumo eléctrico:** 1,7–2,7 W
- **Ethernet:** 2 x IEEE 802.3 Conmutador 10/100 Mbps

Limpieza

Use un paño antiestática. No utilice agua ni productos de limpieza, ya que podrían dañar la superficie o los componentes electrónicos del aparato.

Eliminación



Este teléfono está sujeto a la Directriz Europea 2002/96/EC, y no puede ser eliminado con los residuos domésticos generales.



Si no sabe dónde puede desechar el dispositivo al final de su vida útil, contacte con su municipio, su proveedor de gestión de residuos local, o su vendedor.

Inicialización y registro del teléfono

Importante: Necesitará la información de registro que le haya proporcionado su proveedor de internet o su administrador de red, normalmente el número de teléfono, la extensión, la contraseña y el registro.

Cuando haya instalado el teléfono y lo haya conectado a la red como se indica en las páginas 2-5, el teléfono empezará a inicializar.

Normalmente la inicialización es totalmente automática y se realiza a través del protocolo DHCP. Si su red no admite DHCP, debe obtener la dirección IP, la máscara de red, el IP de la puerta de enlace y el servidor DNS de su proveedor de internet o su administrador de red e introducirlos manualmente cuando se le solicite en la pantalla.

Cuando se le indique, seleccione una opción con  y guarde los cambios con .

- Idioma. El idioma por defecto es inglés. Tiene otros idiomas disponibles si el teléfono/red está conectado a internet durante la inicialización, de modo que se los puede proporcionar el servidor snom automáticamente (firmware 7 y superior).
- Tono de marcado
- Huso horario
- Introduzca la cuenta/el número de teléfono y pulse ✓
- Introduzca el registro (Registrar) y pulse ✓. Si el registro se realizó correctamente, la pantalla mostrará:

Cuenta → 156 16:05 ← Hora
 ← Dispositivo audio actual

Introducir letras, números y caracteres especiales

El modo de entrada en uso se indica en pantalla mediante "123" (números), "abc" (minúsculas), "ABC" (mayúsculas).

▼	Cambiar el modo de entrada	▲	Eliminar el carácter a la izquierda del cursor
◀	Mover el cursor a la izquierda	▶	Mover el cursor a la derecha

Introducir caracteres especiales y símbolos en modo letras: Pulse la tecla "1" una o varias veces rápidamente, con una breve pausa después de cada letra.

Ejemplos: 1x = "." 2x = "+" 3x = "@" 4x = "!" 5x = ":",

De un vistazo

Tecla de navegación

Navegar en menús y listas. En modo inactivo:

- Listas de llamadas: ▲
- Menú Ajustes: ▼

Tecla Cancelar

- Terminar llamadas
- Cancelar acciones
- Eliminación de entradas

Teclas de audio

- Ajuste de volumen
- Altavoz (encendido/apagado)

Teclas alfanuméricas

Tecla asterisco

- Pulsado brevemente en modo de edición: Alternar entre minúsculas y mayúsculas
- Pulsado durante varios segundos: Bloquear/desbloquear el teclado

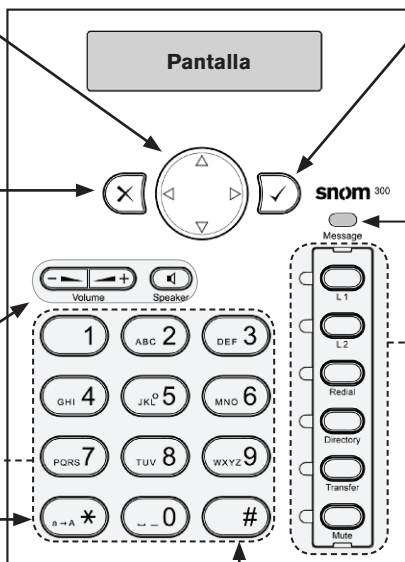

Tecla almohadilla

Tecla Confirmación

Confirmar acciones, selecciones, entradas

LED - mensaje en espera + llamadas perdidas

- Recuperar mensajes: ✓
- Apagar LED después de llamada perdida: X

Teclas de función programables con LED

Configuración por defecto:

- L1, L2: Líneas externas
- Redial: Rellamada
- Directory: Directorio
- Transfer: Transferir una llamada
- Mute: Micrófono (encendido/apagado)

LEDs de las teclas de línea (L1, L2)

- Parpadeo rápido: Llamada entrante. Pulse la tecla para aceptar la llamada.
- Luz fija: Llamada en curso
- Parpadeo lento: Llamada en espera

Modo usuario/modo administradore

La configuración por defecto de fábrica es el modo de administrador. La contraseña del administrador es 0000 (4 x cero). Cambiar el modo:

- Del modo de administradore a modo de usuario: Interfaz web del teléfono > Avanzado > Qos/Security > Seguridad > Modo Administrador: apagado > Salvar.
- Del modo de usuario a modo de administradore: Interfaz web del teléfono > Avanzado > Administrador Acceso: introducir la contraseña de administrador en la caja de texto > Salvar.

Menú Ajustes

En modo inactivo: Pulse ▼ para abrir el menú Ajustes (submenú "Desvío hacia"). Pulse ▼ ▲ para ir al final del menú Ajustes (submenú "Información"). Pulse × para volver a la pantalla anterior o a la pantalla inactivo.

Desvío hacia
*Apagado

* Asterisco antepuesto: Opción activa en ese momento.

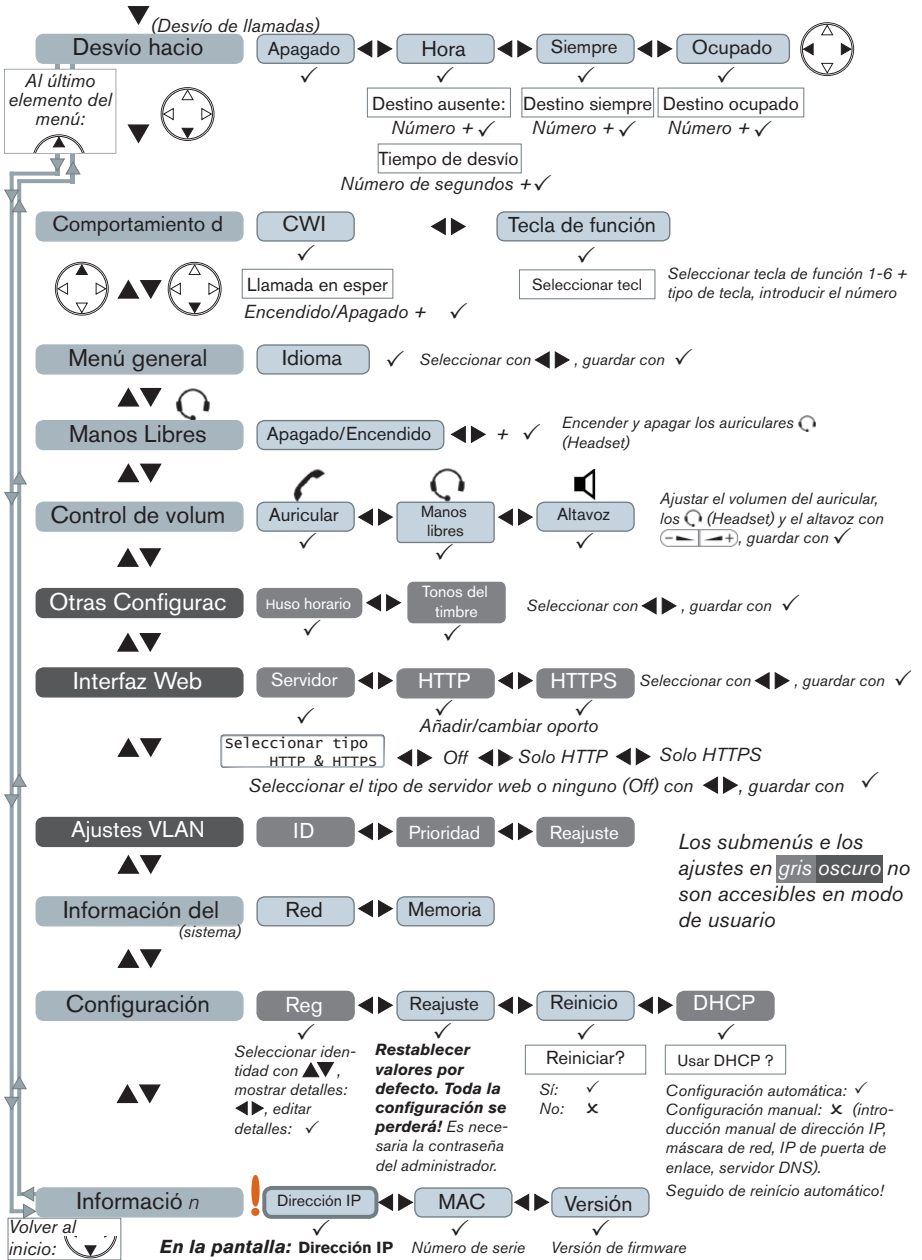

La interfaz web del teléfono

1. Obtenga la dirección IP del teléfono: ▼ ▲ ↻ , por ejemplo 192.168.10.115.
2. Abra el navegador de su PC y teclee http:// seguido de la dirección IP en la barra de direcciones. Pulse la tecla Enter para abrir la interfaz web del teléfono.
3. Haga clic en un elemento del menú a la izquierda para abrir la página.

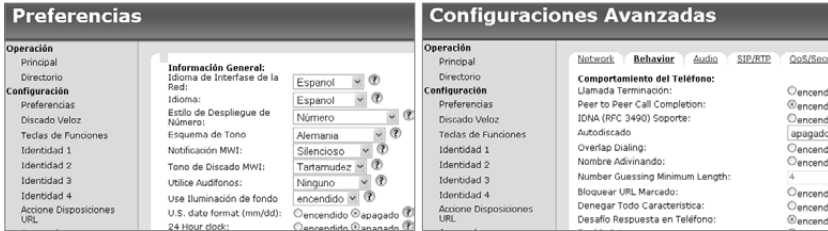

4. Si una ventana contiene diversas páginas, haga clic en la pestaña de la parte superior de la página para abrirla. La fuente de los caracteres de la pestaña activa está en **negrita**.
5. Los cambios que realice no tendrán efecto hasta que haga clic en "Salvar". Se perderán todos los cambios si abre otra página de la interfaz web o si cierra la interfaz web sin haber pulsado antes "Salvar".

Formato de hora

Interfaz Web > Preferencias > Información General > 24 Hour clock:
 On: Formato 24 horas, 00:01 - 24:00
 Off: Formato 12 horas AM/PM, 0:01 A - 12:00 P

Configuración y modificación de la identidad (cuenta)

Interfaz Web > Identidad 1-4

Uso del teléfono

Selección de identidad para la llamada saliente actual

desde la pantalla inactiva: Pulse ◀▶ para seleccionar una de las identidades configuradas.

Realizar llamadas

- Introduzca el número y descuelgue el auricular, o
- Descuelgue el auricular, introduzca el número y pulse ✓, o
- , introduzca el número, ✓.

Marcación rápida

Configuración: Interfaz web > Discado Veloz. Introduzca el número de teléfono con cualquier prefijo necesario en el campo de texto en un número o carácter especial. **NO AÑADA UN NOMBRE ANTES NI DESPUÉS DEL NÚMERO!** Ejemplo: Introduzca el número (911) 555-1234 como 9115551234.



Cómo utilizar el marcado rápido: Introduzca el número o * o # en el teclado alfanumérico y pulse ✓.

Números de emergencia

Pueden marcarse aunque el teclado esté bloqueado. Deben configurarse previamente en la interfaz web.

Configuración: Interfaz web > Preferencias > Lock Keyboard > Emergency Numbers (space separated). Teclee cada número sin espacios entre los dígitos, separe los números de teléfono con un espacio vacío en medio. Ejemplo: 911 115 986543. Los números "911", "115" y "986543" pueden marcarse aunque el teclado esté bloqueado.

Aceptar llamadas

- Con el auricular: Descuelgue el auricular
- Con un auriculares : Pulse  o la tecla de línea que parpadee
- Con el altavoz: Pulse 

Poner la llamada en curso en espera

Pulse la tecla de línea de la llamada. El LED empezará a parpadear lentamente. Vuelva a pulsar la tecla de línea para retomar la llamada.

sostenida 1
 Jane Doe

Conferencia a tres

1. Ponga la primera llamada en espera.
2. Llame al segundo participante. Con la segunda llamada en línea:

John Smith	0:10
Conf.en	
3. Pulse ✓ para iniciar la conferencia. Conferencia en curso:

Jane Doe	1:20
Conf.ap	
4. Parar la conferencia y poner los participantes en espera: ✓.
5. Retomar la conferencia: Pulse la tecla de línea de uno de los participantes y ✓.

sostenida 2
 John Smith

Transferencia de llamadas

Transferencia asistida: Ponga la llamada en espera > Marque el número al que desea transferir la llamada. Si el destinatario desea aceptar la llamada, pulse la tecla Transfer.



Transferencia directa (sin anunciar la llamada): Con la llamada en la línea: Pulse la tecla Transfer, introduzca el número del destinatario, pulse ✓.

Desvío de llamadas

- Activar el desvío de llamadas.
 - Todas las llamadas entrantes: ▼ Desvío hacia > ►► Siempre > ✓ > Destino siempre > introducir el número al que desviar la llamada > ✓.
 - Cuando la línea esté ocupada: ▼ Desvío hacia > ◀ Ocupado > ✓ > Destino ocupado > introducir el número de teléfono > ✓.
 - Tras tiempo excedido: ▼ Desvío hacia > ◀ Hora > ✓ > Destino ausente > introducir el número de teléfono > Tiempo de desvío > introducir el número de segundos tras los que se debe desviar la llamada > ✓.
 - Pantalla inactiva con desvío de llamadas activado: 
- Desactivar: ▼ Desvío hacia > Apagado > ✓.

Listas de llamadas

- Para abrir: Pulse ▲ desde la pantalla inactiva.
- Seleccionar una lista (Perdidas, Recibidas, Marcadas): ◀► > ✓
- Seleccionar un número de teléfono de la lista: ▲▼.

Directorio telefónico

- Para abrir la lista de entradas: Pulse la tecla Directory  Directory
- Localizar una entrada: ▲▼. Ir directamente a <Nueva entrada>: ▲.
- Marcar ◀► Detalles ◀► Editar ◀► Borrar

Solución de problemas

Reinicio (Reboot)

- ▼▲▲ Configuración ►► Reiniciar > ✓ > "Reiniciar?" > ✓

Reinicio físico

Desconecte el cable de alimentación del teléfono. Vuelva a conectar la alimentación pasados unos segundos.

No desconecte el cable de alimentación mientras se está actualizando de Firmware !

Restablecer valores de fábrica

- ▼▲▲ Configuración ► Reajuste > introducir la contraseña de administrador > ✓

Toda la configuración se borrará !

PORTUGUÊS

Este manual de iniciação rápida descreve a instalação, configuração e operação de um snom 300. Para mais informações, consulte o manual disponível na nossa página na rede:

<http://wiki.snom.com/Snom300>.

Copyright, Marcas Comerciais, GPL, Reclamações Legais

© 2010 snom technology Aktiengesellschaft

Todos os direitos reservados.

snom, os nomes dos produtos snom, e logotipos snom são marcas pertencentes à snom tecnologia AG. Todos os outros nomes de produtos e nomes de empresas são propriedade dos seus respectivos proprietários.

snom tecnologia AG reserva o direito de rever e alterar este documento a qualquer momento, sem ser obrigado a anunciar tais revisões ou alterações antes ou depois do facto.

Textos, imagens, ilustrações e sua disposição neste documento estão sujeitos à proteção de direitos autorais e outros direitos legais a nível mundial. A sua utilização, reprodução e transmissão a terceiros, sem expressa autorização por escrito pode resultar em processos judiciais nos tribunais penais, bem como nos tribunais civis.

Embora já se tenham tomados os devidos cuidados na elaboração e apresentação das informações contidas neste documento, os dados em que se baseiam podem mudar sem aviso, pelo que, snom rejeita todas as garantias e responsabilidades pela não exactidão, integridade e atualização das informações publicadas, salvo em caso de ou negligência grosseira por parte da snom ou quando a responsabilidade surge devido à sua ligação a disposições legais.

Nosso firmware inclui fonte de código que pode ser usado e modificado por todo e qualquer um mediante Licença Pública GNU (GPL) (ver Anexo na página), desde que, por sua vez, o torne disponível para todos os outros, sob o mesmo acordo de licenciamento. Por favor, acesse a <http://www.snom.com/en/support/download/gpl-quellcode/> para obter a licença GPL original e a fonte de código para componentes licenciados sob GPL e usado em produtos snom.

Informações Importantes

Por favor, leia as instruções de segurança e de eliminação, bem como as de configuração e utilização do aparelho, antes de usá-lo e recomende a outros utilizadores que as leiam ou informe-os do conteúdo. Guarde este manual e não transfira o dispositivo a terceiros sem incluí-lo.

Instruções de Segurança

Siga as instruções deste manual e outra documentação aplicável ao dispositivo.

- Se o telefone não é fornecido com a corrente através de um cabo Ethernet, use apenas o adaptador de alimentação incluído na embalagem ou outro expressamente recomendado pela snom tecnologia. Outras fontes de alimentação podem danificar ou destruir o telefone, afectar o seu comportamento, ou provocar ruído.

- Evite colocar os cabos onde as pessoas, podem tropeçar ou onde podem ficar expostas a pressão mecânica, pois pode danificá-los.
- Este dispositivo é apenas para uso doméstico! Não instale ao ar livre - NÃO SE DESTINA A UTILIZAÇÃO AO AR LIVRE!
- Não instale o aparelho em ambientes com elevada humidade (por exemplo, em banheiros, lavanderias, cave húmida). Não mergulhe o aparelho em água e não o derrame nem permita o contacto com líquidos de qualquer tipo.
- Não instale o aparelho em ambientes com risco de explosões (lojas de tintas, por exemplo). Não utilize o dispositivo se sentir cheiro de gás ou outros químicos potencialmente explosivos.
- Não utilize o dispositivo durante trovoadas. Raios que atingem a rede eléctrica podem causar choque eléctrico.

SELV (Tensão Extra Baixa de Segurança)

A segurança das ligações de Entrada/Saída cumpre com os requisitos SELV.

Atenção: Para evitar choque eléctrico, não ligue a Tensão Extra Baixa de Segurança (SELV) aos circuitos de tensão da rede telefónica (TNV). As entradas LAN contêm circuitos SELV e as POTS contêm circuitos TNV. Algumas entradas LAN e POTS usam ligações RJ-45 (8P8C). Tenha cuidado ao ligar os cabos.

Padrões de Conformidade



Este dispositivo possui a certificação CE e FCC e cumpre as normas europeias e dos E.U.A relativos à saúde, segurança e meio ambiente.

A abertura não alteração ou modificação do aparelho não autorizada fará com que a garantia seja anulada e pode também resultar na extinção das certificações CE e FCC. Em caso de mau funcionamento contacte o pessoal autorizado, o vendedor, ou a snom.

- **Segurança:** IEC 60950-1:2001, CB Teste Certificação: DE 2-013297
- **Certificados:** FCC Classe B, CE Marca
- **Consumo de energia:** 1,7 – 2,7 Watt
- **Tensão:** 5 V DC ou PoE (Power over Ethernet) IEEE 802.3af, Classe 1
- **1 x LAN, 1 x PC:** RJ45 (Ethernet)
- **Ethernet:** 2 x IEEE 802.3 da 10/100 Mbps

Limpeza

Para limpar o aparelho, use um pano anti-estático. Por favor, evite líquidos de limpeza, já que podem danificar a superfície ou a parte eletrónica no interior do dispositivo.

Eliminação do dispositivo



Este dispositivo está sujeito à directiva europeia 2002/96/CE e não pode ser eliminado com lixo doméstico.

Se não tem conhecimento do local de eliminação do dispositivo no final do ciclo de vida útil, contacte o gestor de resíduos local do seu município ou o vendedor do dispositivo.

Iniciando e Registrando o Telefone

Por favor note: Terá a informação de registo que recebeu do seu fornecedor de serviços de Internet ou o administrador de rede: normalmente o número de telefone ou de extensão, a senha e do registo.

Depois de definir o telefone e ligá-lo à rede, conforme indicado nas páginas 2 - 5, o telefone começa a funcionar.

Normalmente, a iniciação é completamente automática, utilizando o DHCP. Se a rede não suporta DHCP, deve obter o endereço IP, netmask, gateway IP e servidor DNS do seu provedor de serviços de Internet ou o administrador da rede e inseri-los manualmente, quando for solicitado a fazê-lo na tela.

Assista a exibição e, quando solicitado, faça as  e salve-as .

1. Língua. A língua padrão é o Inglês. Outras línguas estão disponíveis se o telefone/rede está ligado à Internet durante a iniciação, para que possam ser fornecidos a partir do servidor snom automaticamente (firmware 7 e superior).
2. Tom de chamada
3. Hora local
4. Digite o número da conta. Salve com ✓
5. Entre na secção. Salvar com ✓. Se bem-sucedido o visor apresentará a tela principal:

Conta → 156 16:05 ← Hora
 ← Dispositivo áudio atual

Digitar números, letras e caracteres especiais

O modo de entrada é indicado na tela de exposição pelos "123" (dígitos), "abc" (letras minúsculas), "ABC" (letras maiúsculas).

▼	Mudar o modo de entrada	▲	Apagar o caractere à esquerda do cursor
◀	Move o cursor para a esquerda	▶	Move o cursor para a direita

Introduz os caracteres especiais e símbolos no modo de entrada: Pressione a tecla "1" uma ou mais vezes, rapidamente, com uma pausa depois de cada caracter.

Exemplos: 1x = "." 2x = "+" 3x = "@" 4x = "1" 5x = ":"

Num ápite

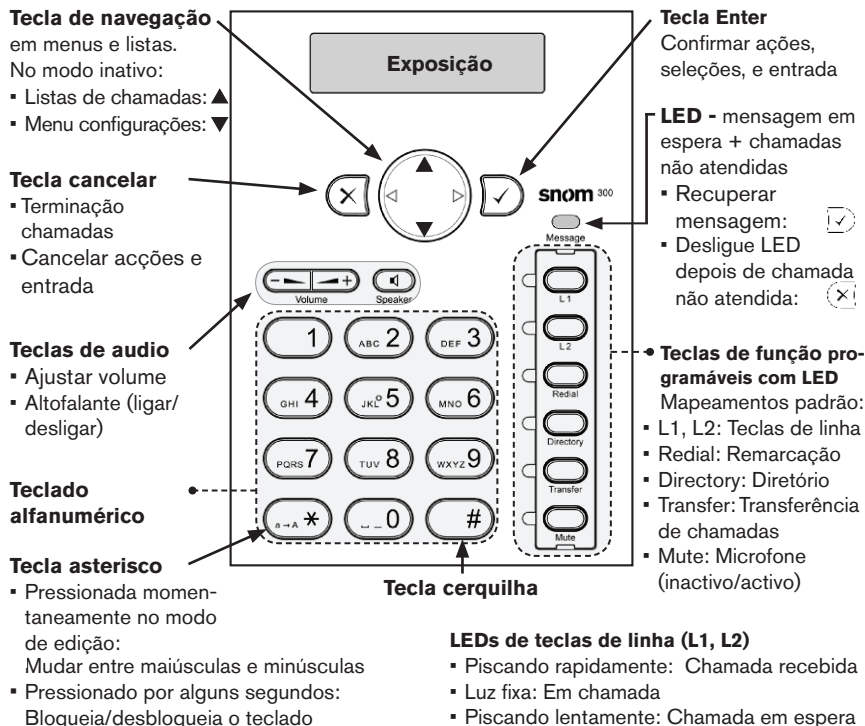

Modo usuário/modo administrador

A configuração padrão é o modo de administrador. A senha de administrador padrão é 0000 (4 x zero). Mudar do modo administrador para o modo utilizador e vice-versa:

- Do modo administrador para o modo utilizador: Interface web do telefone > Avançado > Qos Security > Segurança > Modo de Administrador: Desligado > Salvar.
- Do modo utilizador para o modo administrador: Interface web do telefone > Avançado > Login do Administrador: digite a senha do administrador > Salvar.

Menu de Configurações

No modo inativo: Pressione ▼ para aceder ao topo da lista (Chamadas Feitas), pressione ▼ ▲ para aceder directamente ao final da lista (Informações). Pressione × para voltar ao ecrã anterior ou o ecrã inactivo.

Evento Redirecção
*Off

* Asterisk antecedendo uma opção: Neste momento selecção activa.

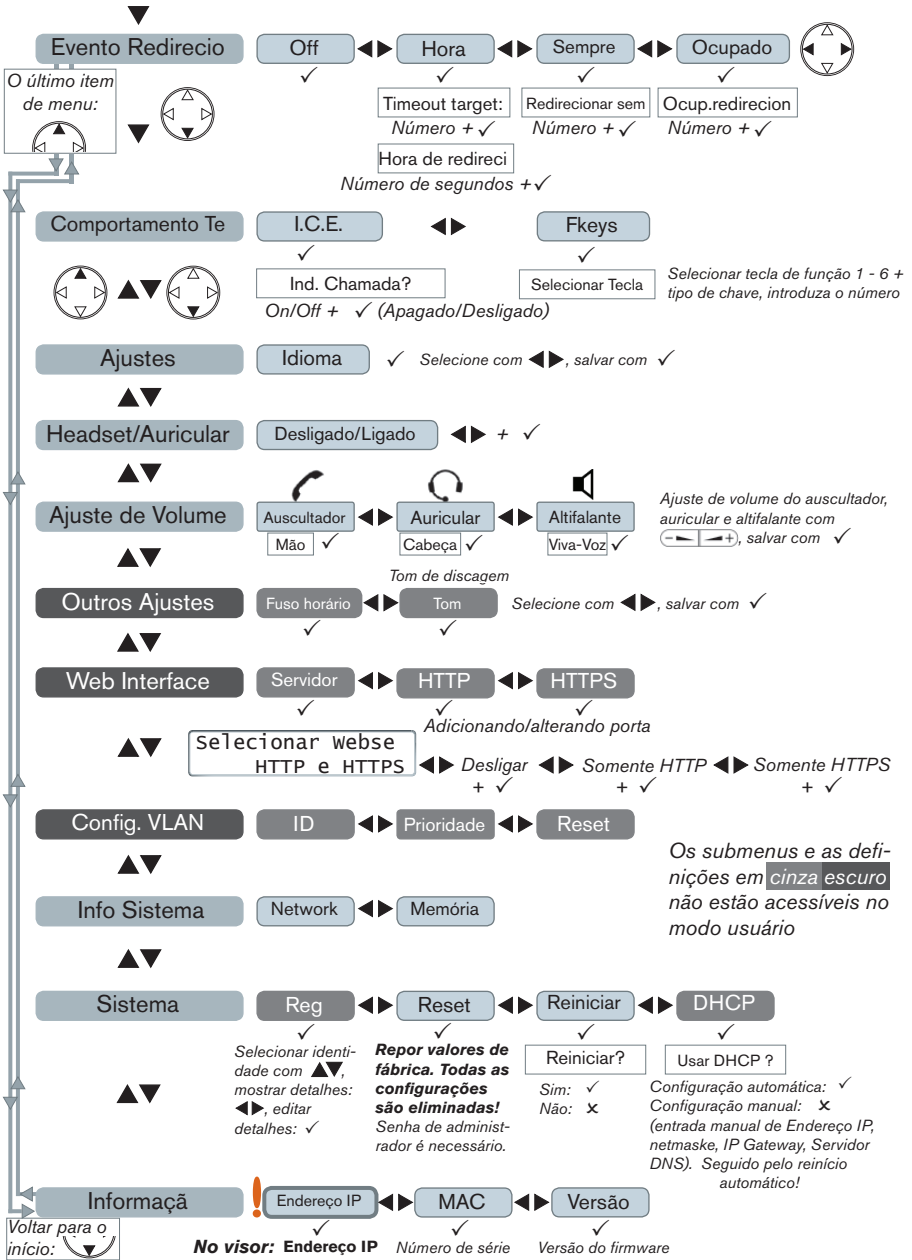

A interface web do telefone

1. Obter o endereço IP do telefone: ▼ ▲ ↻, por exemplo 192.168.10.115.
2. Abra um navegador web em seu PC. Digite http:// seguido pelo endereço IP na barra de endereços e pressione ENTER para abrir a interface web do seu telefone.
3. Clique em um item no menu do lado esquerdo da tela para abrir a janela.



4. Se uma janela contém várias páginas, clique na aba no topo para abrir a página. O peso da fonte dos caracteres no guia da página visível está em **negrito**.
5. Quaisquer alterações feitas não terão efeito até que você clique em "Salvar". As alterações perderseão se abrir uma outra página da interface web sem clicar antes em "Salvar".

Formato da hora

Interface Web > Preferências > Informação Geral > 24 Hour clock:
 Ligado: Formato de 24 horas, 00:01 - 24:00
 Desligado: Formato de 12 horas AM/PM, 0:01 A - 12:00 P

Configuração da identidade/conta

Interface Web > Identidad 1-4

Utilizar o telefone

Selecione uma identidade para as chamadas efectuadas

a partir da ecrã inativo: ◀ ▶

Fazer chamadas

- Digite o número através do teclado alfanumérico e pegue no auscultador ou
- digite o número e pressione ✓ ou
- > digite o número > ✓.

Marcacao veloz

Configuração: Interface web > Discado Veloz. Digite o número do telefone com o prefixo necessário no campo de texto em número ou em caractere especial. Nao

adicionar nomes antes nem após a emissão! Exemplo: Digite o número do telefone (911) 555-1234 como 9115551234.



Como usar Marcacao veloz: Digite o número ou * ou # no teclado alfanumérico e pressione ✓.

Os números de emergência

Podem ser marcados mesmo se o teclado está bloqueado. Devem ser definidos previamente na interface web.

Configuração: Interface web > Preferências > Lock Keyboard > Emergency Numbers (space separated). Digite cada número de emergencia sem espaço entre os dígitos, mas números de telefone com espaço. Exemplo: 911 115 986543. Os números "911", "115" e "986543" podem ser marcados mesmo se o teclado é bloqueado.

Aceitar chamadas

- Com o auscultador: Levantar o auscultador
- Com o auricular: Pressione a  ou a tecla de linha e aceite a chamada
- Com o altifalante: Pressione a 

Colocar chamadas em curso em espera

Pressione a tecla de linha da chamada. O LED começa a piscar lentamente. Pressione a tecla novamente para retomar a chamada.

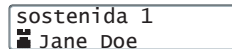

Conferência a tres

1. Coloque a primeira chamada em espera.
2. Ligue para o segundo participante. Com a segunda chamada na linha:
3. Iniciar a conferência: ✓. Conferência em curso:
4. Suspender a conferência e colocar os participantes em espera: ✓.
5. Iniciar a conferência de novo: Pressione a tecla de linha de um dos participantes > ✓.

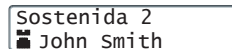
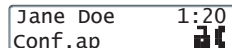
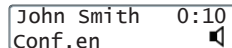

Transferir chamadas manualmente

Transferência anunciada: Colocar a chamada em espera > disque o número que deseja transferir a chamada > se o terceiro quiser aceitar a chamada: Pressione a chave Transfer.

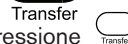

Transferência cega (sem anúncio): Com a chamada em linha: Pressione  > disque o número de telefone para onde a chamada vai ser transferida > ✓.

Encaminhar chamadas

Ecrã inativo com desvio de chamadas activado: 156 16:05
Desv.

1. Activar o encaminhamento de chamadas.
 - a. Todas as chamadas recebidas: ▼ Evento Redirecio > ►► Sempre > ✓ > Redirecionar sem > digite o número de telefone > ✓.
 - b. Se estiver ocupado: ▼ Evento Redirecio > ◀ Ocupado > ✓ > Ocup. redirecion > digite o número de telefone > ✓.
 - c. Se a chamada não for atendida: ▼ Evento Redirecio > ► Hora > ✓ > Timeout target > digite o número de telefone > Hora de redireci > digite o número de segundos seguintes que o convite deverá ser enviado > ✓.
2. Desactivar: ▼ Evento Redirecio > Off > ✓.

Listas de chamadas (Histórico de chamadas)

1. Para abrir: Pressione ▲.
2. Selecionar uma lista (Perdida(s), Recibida(s), Discada(s)) com: ◀►✓
3. Selecionar um número de telefone da lista: ▲▼.

Directório



- Para abrir: Pressione a chave Directory
- Localizar uma entrada: ▲▼. Atalho para <Novo item>: ▲.
- Discar ◀► Detalhes ◀► Editar ◀► Apagar

Solução de problemas

Reiniciar (Reboot)

▼▲▲ Sistema ►► Reiniciar > ✓ > "Reiniciar?" > ✓

Reinício bruscamente

Desligue o cabo de alimentação > aguarde alguns segundos > reconecte.

Não corte a energia durante uma atualização de firmware !

Restaurar as configurações de fábrica

▼▲▲ Sistema ► Reset > digite a senha do administrador > ✓

Todas as configurações perder-se-ão !

COPYRIGHT NOTICE AND WARRANTY
DISCLAIMER

I. Das Produkt enthält Software, die unter der GNU General Public License, Version 2, frei genutzt werden darf.

This Product contains Software applicable to GNU General Public License, Version 2 which can be used freely.

II. Im Verhältnis zu den Lizenzgebern der Software gilt der folgende Haftungsausschluss:

Towards the licensor of this Software the following liability is disclaimed:

This program is distributed in the hope that it will be useful, but WITHOUT ANY WARRANTY; without even the implied warranty of MERCHANTABILITY or FITNESS FOR A PARTICULAR PURPOSE. See the GNU General Public License for more details.

III.

Der Lizenztext der GPL lautet wie folgt:

The GNU General Public License is as follows:

GNU GENERAL PUBLIC LICENSE
Version 2, June 1991

Copyright (C) 1989, 1991
Free Software Foundation, Inc.
59 Temple Place, Suite 330
Boston, MA 02111-1307, USA

Everyone is permitted to copy and distribute verbatim copies of this license document, but changing it is not allowed.

Preamble

The licenses for most software are designed to take away your freedom to share and change it. By contrast, the GNU General Public License is intended to guarantee your freedom to share and change free software—to make sure the software is free for all its users. This General Public License applies to most of the Free Software Foundation's software and to any other program whose authors commit to using it. (Some other Free Software Foundation software is covered by the GNU

Library General Public License instead.) You can apply it to your programs, too.

When we speak of free software, we are referring to freedom, not price. Our General Public Licenses are designed to make sure that you have the freedom to distribute copies of free software (and charge for this service if you wish), that you receive source code or can get it if you want it, that you can change the software or use pieces of it in new free programs; and that you know you can do these things.

To protect your rights, we need to make restrictions that forbid anyone to deny you these rights or to ask you to surrender the rights. These restrictions translate to certain responsibilities for you if you distribute copies of the software, or if you modify it. For example, if you distribute copies of such a program, whether gratis or for a fee, you must give the recipients all the rights that you have. You must make sure that they, too, receive or can get the source code. And you must show them these terms so they know their rights.

We protect your rights with two steps: (1) copyright the software, and (2) offer you this license which gives you legal permission to copy, distribute and/or modify the software.

Also, for each author's protection and ours, we want to make certain that everyone understands that there is no warranty for this free software. If the software is modified by someone else and passed on, we want its recipients to know that what they have is not the original, so that any problems introduced by others will not reflect on the original authors' reputations.

Finally, any free program is threatened constantly by software patents. We wish to avoid the danger that redistributors of a free program will individually obtain patent licenses, in effect making the program proprietary. To prevent this, we have made it clear that any patent must be licensed for everyone's free use or not licensed at all.

The precise terms and conditions for copying, distribution and modification follow.

GNU GENERAL PUBLIC LICENSE
TERMS AND CONDITIONS FOR COPYING,
DISTRIBUTION AND MODIFICATION

0. This License applies to any program or other work which contains a notice placed by the copyright holder saying it may be distributed

under the terms of this General Public License. The „Program“, below, refers to any such program or work, and a „work based on the Program“ means either the Program or any derivative work under copyright law: that is to say, a work containing the Program or a portion of it, either verbatim or with modifications and/or translated into another language. (Hereinafter, translation is included without limitation in the term „modification“.) Each licensee is addressed as „you“.

Activities other than copying, distribution and modification are not covered by this License; they are outside its scope. The act of running the Program is not restricted, and the output from the Program is covered only if its contents constitute a work based on the Program (independent of having been made by running the Program). Whether that is true depends on what the Program does.

1. You may copy and distribute verbatim copies of the Program's source code as you receive it, in any medium, provided that you conspicuously and appropriately publish on each copy an appropriate copyright notice and disclaimer of warranty; keep intact all the notices that refer to this License and to the absence of any warranty; and give any other recipients of the Program a copy of this License along with the Program.

You may charge a fee for the physical act of transferring a copy, and you may at your option offer warranty protection in exchange for a fee.

2. You may modify your copy or copies of the Program or any portion of it, thus forming a work based on the Program, and copy and distribute such modifications or work under the terms of Section 1 above, provided that you also meet all of these conditions:
 - a) You must cause the modified files to carry prominent notices stating that you changed the files and the date of any change.
 - b) You must cause any work that you distribute or publish, that in whole or in part contains or is derived from the Program or any part thereof, to be licensed as a whole at no charge to all third parties under the terms of this License.
 - c) If the modified program normally reads commands interactively when run, you must

cause it, when started running for such interactive use in the most ordinary way, to print or display an announcement including an appropriate copyright notice and a notice that there is no warranty (or else, saying that you provide a warranty) and that users may redistribute the program under these conditions, and telling the user how to view a copy of this License. (Exception: if the Program itself is interactive but does not normally print such an announcement, your work based on the Program is not required to print an announcement.)

These requirements apply to the modified work as a whole. If identifiable sections of that work are not derived from the Program, and can be reasonably considered independent and separate works in themselves, then this License, and its terms, do not apply to those sections when you distribute them as separate works. But when you distribute the same sections as part of a whole which is a work based on the Program, the distribution of the whole must be on the terms of this License, whose permissions for other licensees extend to the entire whole, and thus to each and every part regardless of who wrote it.

Thus, it is not the intent of this section to claim rights or contest your rights to work written entirely by you; rather, the intent is to exercise the right to control the distribution of derivative or collective works based on the Program. In addition, mere aggregation of another work not based on the Program with the Program (or with a work based on the Program) on a volume of a storage or distribution medium does not bring the other work under the scope of this License.

3. You may copy and distribute the Program (or a work based on it, under Section 2) in object code or executable form under the terms of Sections 1 and 2 above provided that you also do one of the following:
 - a) Accompany it with the complete corresponding machine-readable source code, which must be distributed under the terms of Sections 1 and 2 above on a medium customarily used for software interchange; or,
 - b) Accompany it with a written offer, valid for at least three years, to give any third party, for a charge no more than your cost of physically

performing source distribution, a complete machine-readable copy of the corresponding source code, to be distributed under the terms of Sections 1 and 2 above on a medium customarily used for software interchange; or,

- c) Accompany it with the information you received as to the offer to distribute corresponding source code. (This alternative is allowed only for noncommercial distribution and only if you received the program in object code or executable form with such an offer, in accord with Subsection b above.)

The source code for a work means the preferred form of the work for making modifications to it. For an executable work, complete source code means all the source code for all modules it contains, plus any associated interface definition files, plus the scripts used to control compilation and installation of the executable. However, as a special exception, the source code distributed need not include anything that is normally distributed (in either source or binary form) with the major components (compiler, kernel, and so on) of the operating system on which the executable runs, unless that component itself accompanies the executable.

If distribution of executable or object code is made by offering access to copy from a designated place, then offering equivalent access to copy the source code from the same place counts as distribution of the source code, even though third parties are not compelled to copy the source along with the object code.

4. You may not copy, modify, sublicense, or distribute the Program except as expressly provided under this License. Any attempt otherwise to copy, modify, sublicense or distribute the Program is void, and will automatically terminate your rights under this License. However, parties who have received copies, or rights, from you under this License will not have their licenses terminated so long as such parties remain in full compliance.
5. You are not required to accept this License, since you have not signed it. However, nothing else grants you permission to modify or distribute the Program or its derivative works. These actions are prohibited by law if you do not accept this License. Therefore, by modifying or distributing the Program (or any work based

on the Program), you indicate your acceptance of this License to do so, and all its terms and conditions for copying, distributing or modifying the Program or works based on it.

6. Each time you redistribute the Program (or any work based on the Program), the recipient automatically receives a license from the original licensor to copy, distribute or modify the Program subject to these terms and conditions. You may not impose any further restrictions on the recipients' exercise of the rights granted herein. You are not responsible for enforcing compliance by third parties to this License.
7. If, as a consequence of a court judgment or allegation of patent infringement or for any other reason (not limited to patent issues), conditions are imposed on you (whether by court order, agreement or otherwise) that contradict the conditions of this License, they do not excuse you from the conditions of this License. If you cannot distribute so as to satisfy simultaneously your obligations under this License and any other pertinent obligations, then as a consequence you may not distribute the Program at all. For example, if a patent license would not permit royalty-free redistribution of the Program by all those who receive copies directly or indirectly through you, then the only way you could satisfy both it and this License would be to refrain entirely from distribution of the Program.

If any portion of this section is held invalid or unenforceable under any particular circumstance, the balance of the section is intended to apply and the section as a whole is intended to apply in other circumstances.

It is not the purpose of this section to induce you to infringe any patents or other property right claims or to contest validity of any such claims; this section has the sole purpose of protecting the integrity of the free software distribution system, which is implemented by public license practices. Many people have made generous contributions to the wide range of software distributed through that system in reliance on consistent application of that system; it is up to the author/donor to decide if he or she is willing to distribute software through any other system and a licensee cannot impose that choice. This section is intended to make thoroughly clear what is believed to be a consequence of the rest of this License.

8. If the distribution and/or use of the Program is restricted in certain countries either by patents or by copyrighted interfaces, the original copyright holder who places the Program under this License may add an explicit geographical distribution limitation excluding those countries, so that distribution is permitted only in or among countries not thus excluded. In such case, this License incorporates the limitation as if written in the body of this License.
9. The Free Software Foundation may publish revised and/or new versions of the General Public License from time to time. Such new versions will be similar in spirit to the present version, but may differ in detail to address new problems or concerns. Each version is given a distinguishing version number. If the Program specifies a version number of this License which applies to it and „any later version“, you have the option of following the terms and conditions either of that version or of any later version published by the Free Software Foundation. If the Program does not specify a version number of this License, you may choose any version ever published by the Free Software Foundation.
10. If you wish to incorporate parts of the Program into other free programs whose distribution conditions are different, write to the author to ask for permission. For software which is copyrighted by the Free Software Foundation, write to the Free Software Foundation; we sometimes make exceptions for this. Our decision will be guided by the two goals of preserving the free status of all derivatives of our free software and of promoting the sharing and reuse of software generally.

NO WARRANTY

11. BECAUSE THE PROGRAM IS LICENSED FREE OF CHARGE, THERE IS NO WARRANTY FOR THE PROGRAM, TO THE EXTENT PERMITTED BY APPLICABLE LAW. EXCEPT WHEN OTHERWISE STATED IN WRITING THE COPYRIGHT HOLDERS AND/OR OTHER PARTIES PROVIDE THE PROGRAM „AS IS“ WITHOUT WARRANTY OF ANY KIND, EITHER EXPRESSED OR IMPLIED, INCLUDING, BUT NOT LIMITED TO, THE IMPLIED WARRANTIES OF MERCHANTABILITY AND FITNESS FOR A PARTICULAR PURPOSE. THE ENTIRE RISK AS TO THE QUALITY AND PERFORMANCE

OF THE PROGRAM IS WITH YOU. SHOULD THE PROGRAM PROVE DEFECTIVE, YOU ASSUME THE COST OF ALL NECESSARY SERVICING, REPAIR OR CORRECTION.

12. IN NO EVENT UNLESS REQUIRED BY APPLICABLE LAW OR AGREED TO IN WRITING WILL ANY COPYRIGHT HOLDER, OR ANY OTHER PARTY WHO MAY MODIFY AND/OR REDISTRIBUTE THE PROGRAM AS PERMITTED ABOVE, BE LIABLE TO YOU FOR DAMAGES, INCLUDING ANY GENERAL, SPECIAL, INCIDENTAL OR CONSEQUENTIAL DAMAGES ARISING OUT OF THE USE OR INABILITY TO USE THE PROGRAM (INCLUDING BUT NOT LIMITED TO LOSS OF DATA OR DATA BEING RENDERED INACCURATE OR LOSSES SUSTAINED BY YOU OR THIRD PARTIES OR A FAILURE OF THE PROGRAM TO OPERATE WITH ANY OTHER PROGRAMS), EVEN IF SUCH HOLDER OR OTHER PARTY HAS BEEN ADVISED OF THE POSSIBILITY OF SUCH DAMAGES.

END OF TERMS AND CONDITIONS

How to Apply These Terms to Your New Programs

If you develop a new program, and you want it to be of the greatest possible use to the public, the best way to achieve this is to make it free software which everyone can redistribute and change under these terms.

To do so, attach the following notices to the program. It is safest to attach them to the start of each source file to most effectively convey the exclusion of warranty; and each file should have at least the „copyright“ line and a pointer to where the full notice is found.

<one line to give the program's name and a brief idea of what it does>

Copyright (C) <year> <name of author>

This program is free software; you can redistribute it and/or modify it under the terms of the GNU General Public License

as published by the Free Software Foundation; either version 2 of the License, or (at your option) any later version.

This program is distributed in the hope that it will be useful, but WITHOUT ANY WARRANTY; without even the implied warranty of MERCHANTABILITY or FITNESS FOR A PARTICULAR PURPOSE. See the GNU General Public License for more details.

You should have received a copy of the GNU General Public License along with this program; if not, write to the Free Software Foundation, Inc., 59 Temple Place, Suite 330, Boston, MA 02111-1307 USA

IV.

Den vollständigen korrespondierenden Sourcecode der Software schickt Ihnen die snom technology AG auf Nachfrage gerne auf einem üblichen Datenträger gegen Erstattung der Herstellungskosten in Höhe von EUR 5,- zu.

Der vollständige korrespondierende Sourcecode kann auch über unsere Website unter http://www.snom.com/gpl_.html?&L=0 herunter geladen werden.

If requested by you, the complete corresponding source code of the Software can be sent by snom technology AG on a standard data storage medium against the reimbursement of the manufacturing costs of EUR 5.- per unit.

The complete corresponding source code of the Software can also be downloaded from our web site http://www.snom.com/gpl_.html?&L=0.

V.

Weitere Informationen finden Sie auch unter <http://www.snom.com>.

For further information see <http://www.snom.com>.