

# SIP Outdoor Intercom with RFID

The CyberData SIP Outdoor Intercom with RFID is perfect for secure access settings requiring RFID access control and two-way communication. With encrypted RFID, the SIP Outdoor Intercom can increase the security of any VoIP installation.

The product supports up to 500 RFID cards. A card with a blacklisted code will trigger a phone call with a pre-recorded message and/or a multicast stream to IP notification endpoints. The access code list, designating valid entry times or blacklisted users, can be updated manually using the web interface, imported using the web page, or autoprovisioned using the same mechanism as a VoIP phone. For ease of managing your access list, we recommend using the 011425 RFID Secure Access Endpoint as a desktop enrollment device. (see RFID Implementation Guide on the **Installation** tab).

CyberData has maintained one of the most comprehensive lists of IP PBX servers certified to work with CyberData VoIP Products.

## Features

- TLS 1.2 enhanced security for IP Endpoints in a local or cloud-based environment
- Mifare Plus X 2K/4K cards are supported for a high level of encryption
- Alert buzzer
- Red/Green lock status lights
- Built-in time of access scheduler
- Local and remote logging with time stamp
- NTP time support
- Supports 500 RFID Cards
- Blacklisted card alert via dialout or multicast
- Full-duplex voice operation
- Supports SRST in a Cisco environment
- Network web management
- Network adjustable speaker volume and microphone sensitivity
- Network downloadable firmware
- Doubles as a paging speaker
- Custom alert, ringtones and callout messages may be uploaded
- Dry relay contact for auxiliary control
- Door closure and tamper alert signal
- Security Torx screws with driver kit included
- **This product comes with five RFID cards**



## Specifications

Ethernet I/F	10/100 Mbps
Protocol	SIP RFC 3261 Compatible
RFID Card Protocol	ISO/IEC 14443 Type A - 13.56 MHz Standard
Power Input	PoE 802.3af compliant or +8 to +12VDC @ 1000mA Regulated Power Supply (not included)
Speaker Output	2 Watts Peak Power
On-Board Relay	1A @ 30 VDC
Supported RFID cards	Mifare Plus X 2K or 4K
Payload Types	G.711 a-law, G.711 $\mu$ -law, G.722, and G.729
Network Security	TLS/SSL 1.2
IP Rating	IP65
Operating Range	Temperature: -40° C to 55° C (-40° F to 131° F) Humidity: 5-95%, non-condensing
Storage Temperature Storage Altitude	Temperature: -40° C to 70° C (-40° F to 158° F) Up to 15,000 ft. (4573 m)
Dimensions*	Length: 7.480 inch [190 mm] Width: 2.284 inch [58 mm] Height: 5.118 inch [130 mm]
Weight Boxed Weight	2.8 lbs. [1.27 kg] 4.0 lbs. [1.81 kg]
Compliance	CE; EMC Directive – Class A EN 55032 & EN 55024, LV Safety Directive – EN 60950-1, RoHS Compliant, FCC; Part 15 Class A, Industry Canada; ICES-3 Class A, IEEE 802.3 Compliant
Warranty	2 Years Limited
Part Number	011477

\*Dimensions are measured from the perspective of the product being upright with the front of the product facing you.

# SIP Outdoor Intercom with RFID

## Desktop Enrollment with 011425 RFID Secure Access Device

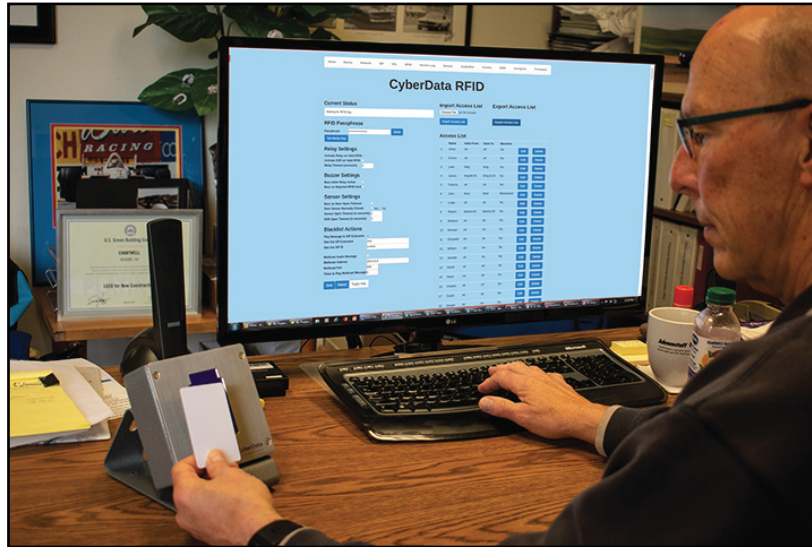

## Secure Card Presentation for Access



### Related Products:

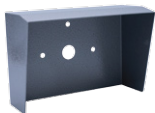

011215 Outdoor Shroud, 2X

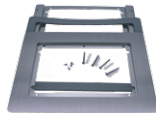

011442 Flush Mount Kit, 2X



011375 Network Dual Door Strike Relay



011269 Door Strike Intermediate Relay Module



011432 Key Fobs and 011422 RFID Cards  
Packets of 10

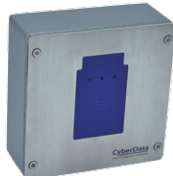

011425 RFID Secure Access Endpoint



011423 Desktop Stand for 1X Outdoor Backboxes



011490 Outdoor Auxiliary RGB (Multi-Color) Strobe Kit

# SIP Outdoor Intercom with RFID

## Dimensions (Front and Side View)

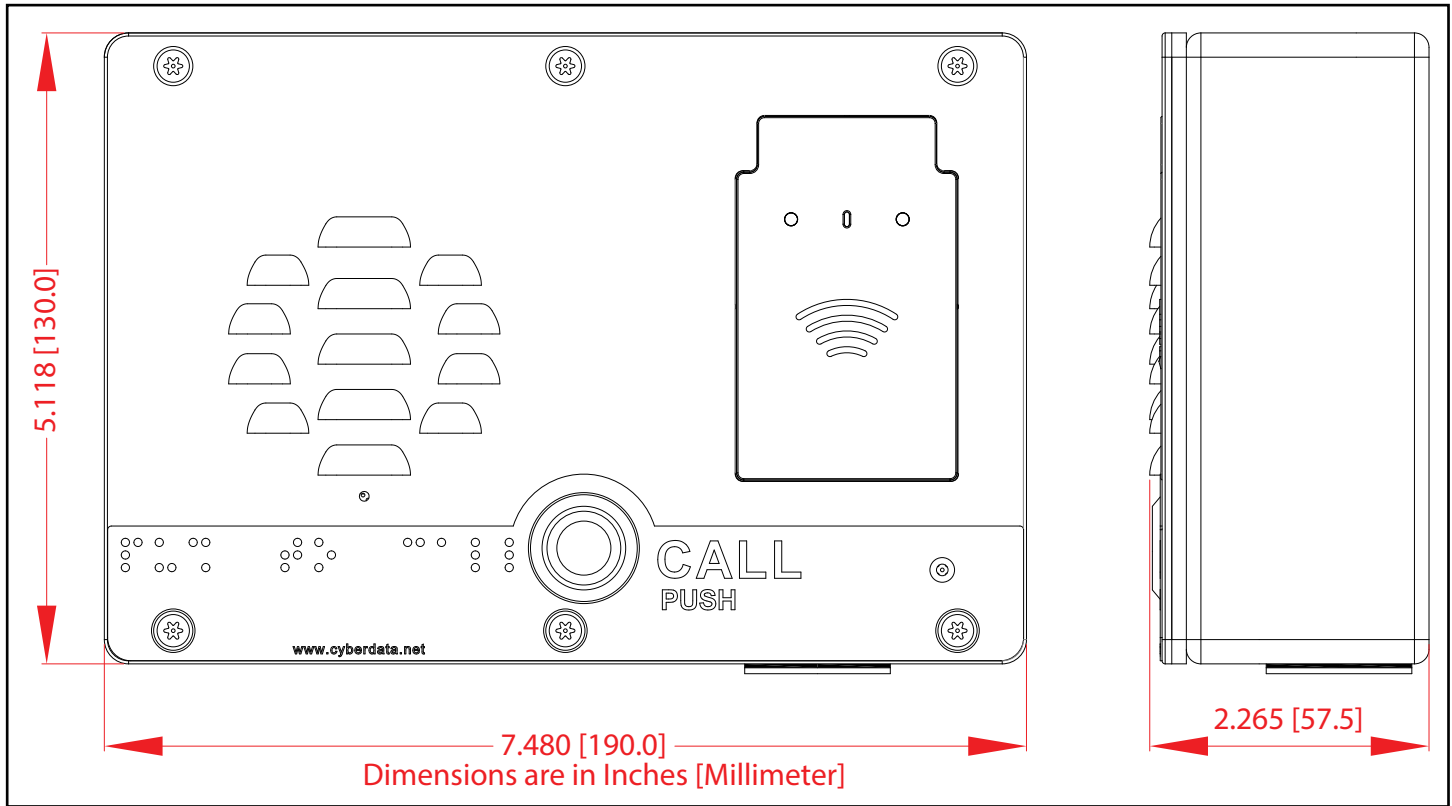

## Dimensions (Rear View and Mounting Holes)

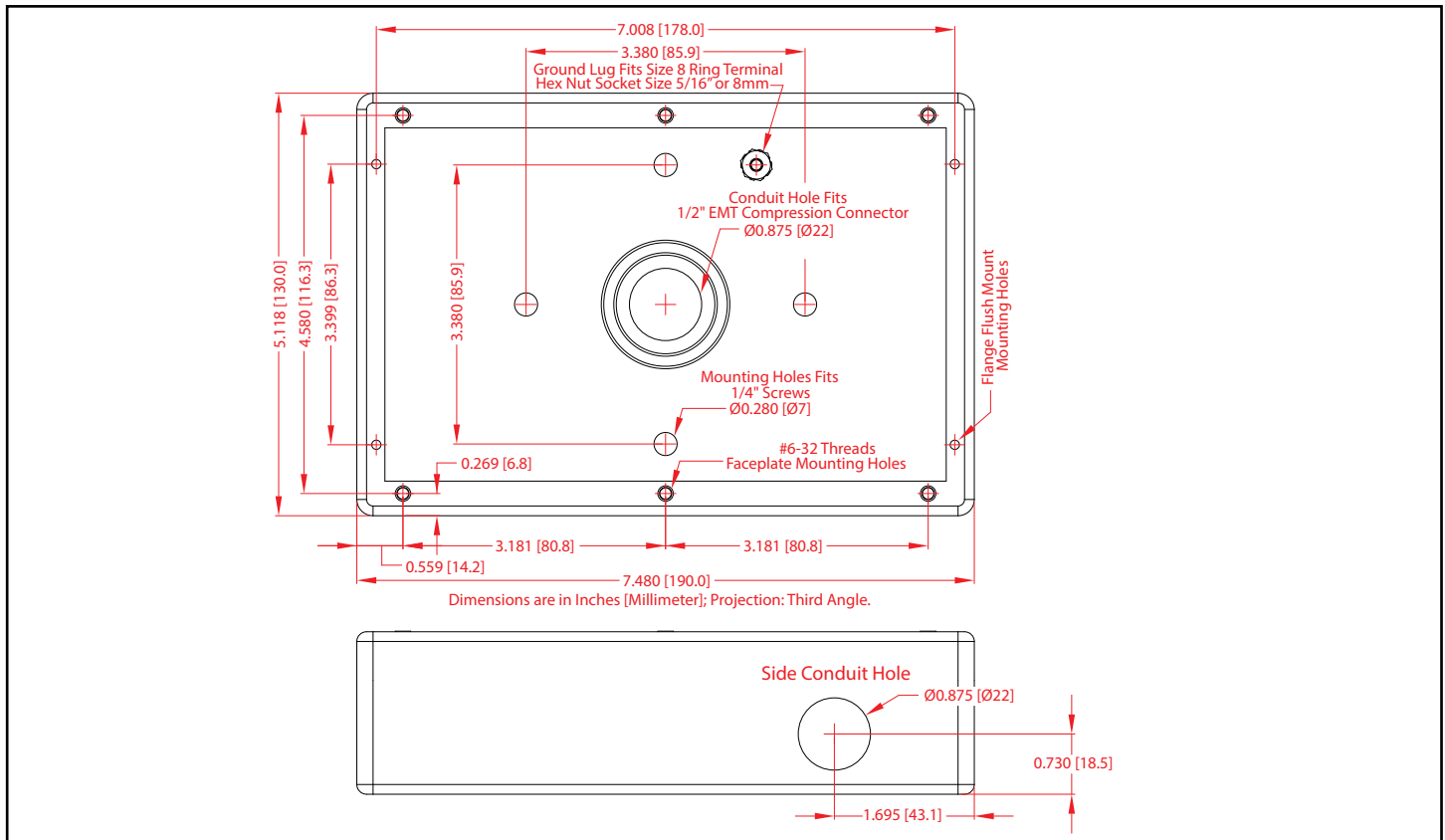

# SIP Outdoor Intercom with RFID

## Securing the Device (and Ground Cable and Network Cable Installation)

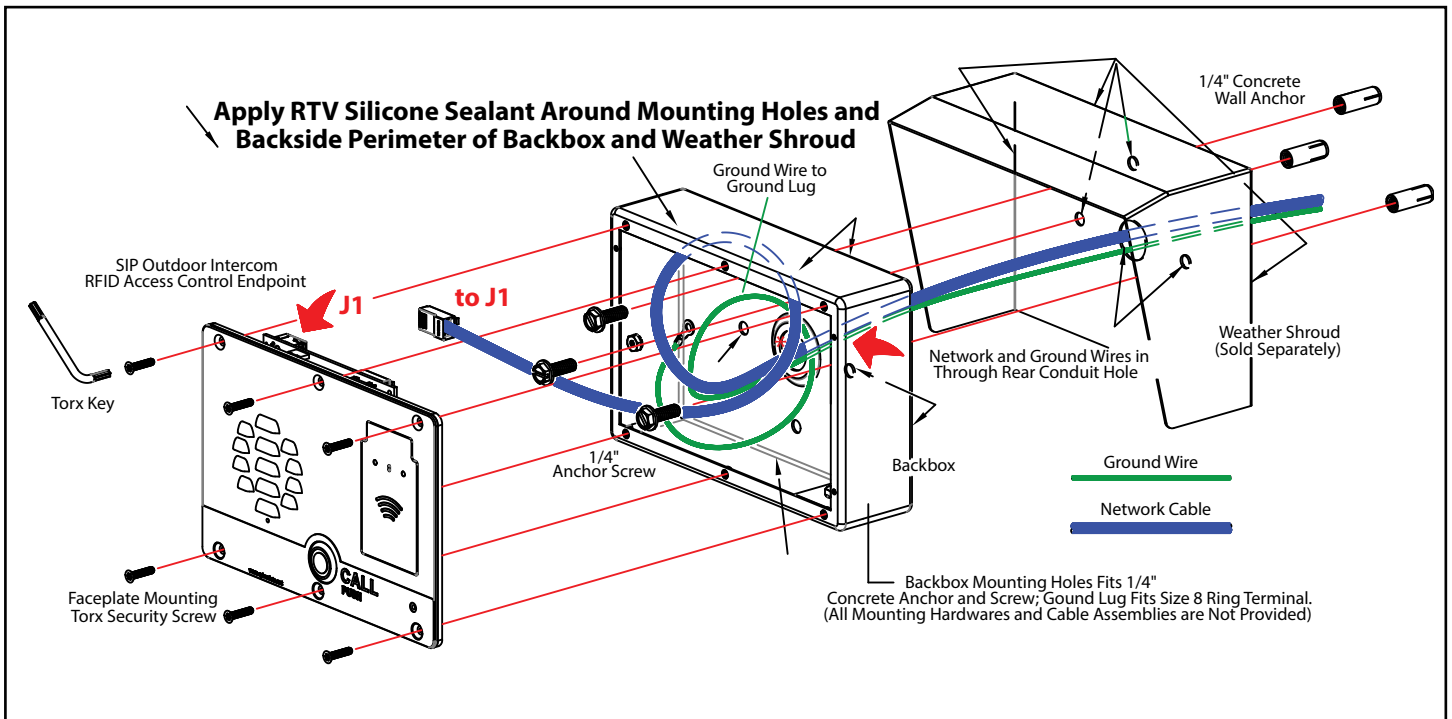

## Gooseneck Conduit Mounting

