

# Grandstream Networks, Inc.

---

DP750/DP720

DECT Cordless IP Phones

**Administration Guide**



## **COPYRIGHT**

©2018 Grandstream Networks, Inc. <http://www.grandstream.com>

All rights reserved. Information in this document is subject to change without notice. Reproduction or transmittal of the entire or any part, in any form or by any means, electronic or print, for any purpose without the express written permission of Grandstream Networks, Inc. is not permitted.

The latest electronic version of this guide is available for download here:

<http://www.grandstream.com/support>

Grandstream is a registered trademark and Grandstream logo is trademark of Grandstream Networks, Inc. in the United States, Europe and other countries.

## **CAUTION**

Changes or modifications to this product not expressly approved by Grandstream, or operation of this product in any way other than as detailed by this guide, could void your manufacturer warranty.

## **WARNING**

Please do not use a different power adaptor with devices as it may cause damage to the products and void the manufacturer warranty.



## GNU GPL INFORMATION

DP750 firmware contains third-party software licensed under the GNU General Public License (GPL). Grandstream uses software under the specific terms of the GPL. Please see the GNU General Public License (GPL) for the exact terms and conditions of the license.

Grandstream GNU GPL related source code can be downloaded from Grandstream web site from:  
<http://www.grandstream.com/support/faq/gnu-general-public-license/gnu-gpl-information-download>



# Table of Contents

<b>DOCUMENT PURPOSE .....</b>	<b>11</b>
<b>CHANGE LOG .....</b>	<b>12</b>
Firmware Version 1.0.4.10 .....	12
Firmware Version 1.0.4.7 .....	12
Firmware Version 1.0.4.2 .....	12
Firmware Version 1.0.3.40 .....	12
Firmware Version 1.0.3.37 .....	12
Firmware Version 1.0.3.34 .....	13
Firmware Version 1.0.3.31 .....	13
Firmware Version 1.0.3.23 .....	13
Firmware Version 1.0.2.16 .....	14
Firmware Version 1.0.1.14 .....	14
Firmware Version 1.0.1.4 .....	14
Firmware Version 1.0.0.16 .....	15
<b>GUI INTERFACE EXAMPLES .....</b>	<b>16</b>
<b>WELCOME .....</b>	<b>17</b>
<b>PRODUCT OVERVIEW .....</b>	<b>18</b>
Feature Highlights .....	18
DP750 Technical Specifications .....	19
DP720 Technical Specifications .....	20
<b>GETTING STARTED .....</b>	<b>22</b>
Equipment Packaging .....	22
Connecting DP750 .....	23
<i>Connecting via AC power</i> .....	23
<i>Connecting via PoE</i> .....	23
Setting up DP720 handset .....	24



<i>Battery Information</i> .....	24
Setting up the Charge Station.....	25
DP750 LED Patterns.....	25
DP720 Handset Description .....	26
DP720 Icons Description .....	27
DP720 Handset Menu.....	29
<b>CONFIGURATION GUIDE .....</b>	<b>32</b>
Obtain DP750 Base Station IP Address via paired DP720.....	32
Configuration via Web Browser .....	33
<i>Accessing the Web UI</i> .....	33
<i>Web GUI Languages</i> .....	33
<i>Icons Bar Shortcut</i> .....	34
<i>Saving the Configuration Changes</i> .....	34
Web UI Access Level Management.....	34
<i>Changing User Level Password</i> .....	35
<i>Changing Admin Level Password</i> .....	35
<i>Changing HTTP / HTTPS Web Access Port</i> .....	36
Web Configuration Definitions .....	37
<i>Status Page Definitions</i> .....	38
<i>Profiles Page Definitions</i> .....	41
<i>DECT Page Definitions</i> .....	51
<i>Settings Page Definitions</i> .....	54
<i>Maintenance Page Definitions</i> .....	56
<i>Phonebook Page Definitions</i> .....	65
Change Base Station Admin PIN code .....	67
Register DP720 Handset to DP750 Base Station .....	68
Using DP720 with Multiple DP750 Base Stations .....	69
<i>Registering DP720 to an additional DP750 base station</i> .....	69
<i>Switching Between Different Base Stations</i> .....	70
Unregister the DP720 .....	71



Locating a DP720 Handset from DP750 Base station.....	72
<i>Locate via DP750 Web UI</i> .....	72
<i>Locate via DP750 Base station</i> .....	72
Register a SIP Account.....	73
<i>Register Account via Web User Interface</i> .....	73
Multiple Lines and Hunting Groups.....	75
<i>Handset Line Settings</i> .....	76
<i>Outgoing Default Line</i> .....	77
<i>Hunting Groups</i> .....	77
Configuration via Keypad.....	80
Call Features.....	81
DP750 Phonebook Management.....	82
<i>Private Phonebook</i> .....	82
<i>Global Phonebook</i> .....	84
<i>Global Phonebook via XML</i> .....	84
<i>Global Phonebook via LDAP</i> .....	88
<b>DP750 ASSOCIATION WITH DP760 DECT REPEATER.....</b>	<b>90</b>
Enabling Repeater Mode on DP750 .....	90
DP760 DECT Repeater Association .....	90
<i>Auto Association</i> .....	91
<i>Manual Association</i> .....	92
<i>Use DP750 Repeater Management to Associate DP760</i> .....	93
<b>DP760 DECT REPEATER DISSOCIATION FROM DP750 .....</b>	<b>96</b>
Using DP760 Web GUI.....	96
Using Page Button .....	97
Using Repeater Management Mode on DP750.....	97
<b>UPGRADING AND PROVISIONING .....</b>	<b>98</b>
DP750 Firmware Upgrade Procedure .....	98
<i>Upgrading via Local TFTP/HTTP Servers</i> .....	99



Upgrading DP720 handset .....	100
<i>Using the LCD menu</i> .....	100
<i>Using the Web GUI</i> .....	100
DP750/DP720 Provisioning .....	101
<i>Configuration File Download</i> .....	101
<i>Handset Provisioning</i> .....	102
<b>RESTORE FACTORY DEFAULT SETTINGS .....</b>	<b>104</b>
Resetting the DP750 Base Station .....	104
<i>Via Reset Button</i> .....	104
<i>Via Web GUI</i> .....	104
Resetting the DP720 Handset .....	104
<b>EXPERIENCING DP750/720 .....</b>	<b>106</b>



## Table of Tables

Table 1: DP750 Features at a Glance .....	18
Table 2: DP720 Features at a Glance .....	18
Table 3: DP750 Technical Specifications .....	19
Table 4: DP720 Technical Specifications .....	20
Table 5: Equipment Packaging .....	22
Table 6: DP750 LED Patterns .....	25
Table 7: Keypad Keys Description .....	26
Table 8: DP720 Icons Description .....	27
Table 9: Status Page Definitions .....	38
Table 10: Profiles Page Definitions .....	41
Table 11: DECT Page Definitions .....	51
Table 12: Settings Page Definitions .....	54
Table 13: Maintenance Page Definitions .....	56
Table 14: Phonebook Page Definitions .....	65
Table 15: Call Features .....	81





## Table of Figures

Figure 1: DP750 Package Content .....	22
Figure 2: DP720 Package Content .....	22
Figure 3: DP750 Back View .....	23
Figure 4: Connecting the Base station .....	23
Figure 5: Setting up the DP720 .....	24
Figure 6: Setting up the charge station .....	25
Figure 7: Handset Keys Description .....	26
Figure 8: DP720 Menu Structure .....	29
Figure 9: DP750 Web GUI Language .....	33
Figure 10: Icons Bar Shortcut .....	34
Figure 11: Icons Bar Description .....	34
Figure 12: User Level Password .....	35
Figure 13: Admin Level Password .....	36
Figure 14: Web Access Port.....	37
Figure 15: Admin PIN Code .....	68
Figure 16: Registration Process.....	69
Figure 17: Multiple Base Stations Registration .....	70
Figure 18: Switching Between Base Stations .....	70
Figure 19: Unregister DP720 from DP750 web UI.....	71
Figure 20: Locate Handset via Web UI .....	72
Figure 21: SIP Settings .....	74
Figure 22: SIP Accounts Settings.....	74
Figure 23: Account Status .....	75
Figure 24: Handset Line Settings.....	76
Figure 25: Account Status – Line Status.....	76
Figure 26: Hunting Group configuration.....	79
Figure 27: Hunting Group Status .....	80
Figure 28: Private Phonebook Settings .....	82
Figure 29: Handset Phonebook Settings .....	83
Figure 30: Handset Phonebook Selection .....	83
Figure 31: Global Phonebook XML Settings .....	84
Figure 32: Automatic XML Phonebook Download .....	85
Figure 33: Manual XML Phonebook Management .....	85
Figure 34: Global Phonebook LDAP Settings.....	88
Figure 35: Shared Contacts .....	89
Figure 36: Enable Repeater Mode .....	90
Figure 37: Repeater Status – Associated (Auto Association).....	91
Figure 38: Repeater Status – Associated (Manual Association).....	93
Figure 39: Repeater Associated Status .....	94



Figure 40: DECT Repeater Status on DP750 .....	95
Figure 41: DECT Repeater Status on DP750 .....	96
Figure 42: DECT Repeater Status on DP750 .....	97
Figure 43: Firmware Upgrade Page.....	99
Figure 44: Handset Firmware Upgrade.....	100
Figure 45: Provisioning Feature .....	102



## DOCUMENT PURPOSE

This document describes how to configure DP750 Base Station features via DP720 Handset LCD menu and Web GUI menu. The intended audiences of this document are VOIP administrators. To learn the basic functions of DP750/DP720, please visit <http://www.grandstream.com/support> to download the latest “DP750/DP720 User Guide”.

This guide covers following topics:

- [Product Overview](#)
- [Getting Started](#)
- [Configuration Guide](#)
- [DP750 Association with DP760 Repeater](#)
- [DP760 DECT Repeater Dissociation from DP750](#)
- [Upgrading and provisioning](#)
- [Restore factory default settings.](#)



## CHANGE LOG

This section documents significant changes from previous firmware versions. Only major new features or major document updates are listed here. Minor updates for corrections or editing are not documented here.

### Firmware Version 1.0.4.10

- Added option to add MAC address to User Agent. [Use MAC Header]

### Firmware Version 1.0.4.7

- Added the ability to display Account Name only. [SIP account display]
- Added support to provision config file by model. [DP750/DP720 Provisioning]
- Added support TLS protocol for Syslog. [Syslog Protocol]
- Added SRTP icon on handset UI. [Table 8: DP720 Icons Description]
- Updated German translations for both DP750 Web UI and DP720 handset UI.

### Firmware Version 1.0.4.2

- Added support for CTI (Computer-Telephony Integration) feature. [[CTI Guide](#)]
- Improve the support to customize the Syslog port. [Syslog port]
- Added support for DP720 to use Audio Loopback test when it is not registered to the base station. [Audio Loopback]
- Play keypad tone during the call if it is enabled. [Audio]

### Firmware Version 1.0.3.40

- Added support to allow configure prefix for User-Agent in SIP header. [User-Agent Prefix]
- Increased the length of Authenticate ID, SIP User ID, Password from 32 to 128.
- Added support for SIP OPTIONS Keep Alive. [Enable OPTIONS Keep Alive]
- Added support for automatic upgrade and provisioning be triggered at a random time in every certain day. [Automatic Upgrade]
- Added OpenVPN feature. [OpenVPN]
- Added the option to set Date and Time Display Format via the web GUI and Provisioning. [Time Format]

### Firmware Version 1.0.3.37

- Added support for DP750 to configure device with custom certificate signed by custom CA certificate. [Device Custom Certificate]
- Added support for DP750 to customize the Syslog port. [Syslog port]
- Reset DP760 repeater region to AUTO when pressing page and reset button more than 2s. [DP750 ASSOCIATION WITH DP760 DECT REPEATER]



### **Firmware Version 1.0.3.34**

- No major changes.

### **Firmware Version 1.0.3.31**

- Added language support for Slovakian, Swedish. [Web GUI Languages]
- Change NTP Server default value to pool.ntp.org. [NTP Server]

### **Firmware Version 1.0.3.23**

- Added Email address to core debug page. [Email Address]
- Implemented Handset Provisioning feature. Add warning information to SIP Account Settings and Line Settings Pages if Handset Provisioning enabled. [Handset Provisioning]
- Added support for more languages and updated translation. [Multi-language]
- Implemented DP750 Debug Tools that allow generate and submit debug files to Grandstream debug server directly. [Debug Tools]
- Add handset notification for base core dump files. [Handset Notification]
- Added web UI support to DP750 for repeater management such as display/link/unlink, etc. [DECT Repeater Status]
- Added backup configuration feature. [Backup Configuration]
- Added UPnP discovery feature. [UPnP Discovery Settings]
- Added support for more languages and updated translation. [Web GUI Languages]
- Added DP750/DP720 product resource link to DP750 web UI. [Support Documentation]
- Added support for page refresh by Refresh Page button, and added the icons of Refresh Page, Open Subscription and Page All button to icon bar. [Icons Bar Shortcut]
- Added support to auto-refresh on DECT status web UI. [DECT Base Status]
- Added the ability to customize DP720 ringtones. [Custom Ringtone]
- Enhanced factory reset feature by adding options to select Full RESET, RESET without deleting handsets subscription or RESET only deleting handset subscription. [Reset Type]
- Added capability to rename the profile. [Profile Name]
- Added support for Distinctive Ringtone based on a customized SIP Alert-info header. [Match Incoming Caller ID]
- Removed “Disable Call Waiting Tone” from Profile page and add it under DECT → Handset Settings [Disable Call Waiting Tone]
- Added support to upload TXT configuration file. [Upload Device Config]
- Added a new tab named “Support” under Maintenance page for support document, configuration support and debug tools. [Support]
- Added DP750 the ability to send SIP INFO and RFC2833 at same time. [Send DTMF]
- Added force reboot button to web UI to force reboot DP750 in factory reset page under maintenance section. [Force Reboot]



## Firmware Version 1.0.2.16

- Added TR-069 CPE support. [TR-069]
- Added Repeater mode support at DECT → General Settings. [Enable Repeater Mode]
- Added support of plus button '+' when dialing. [Dial Plan]
- Added "Verify host when using HTTPS" option at Maintenance → Firmware Upgrade. [Verify host when using HTTPS]
- Added status displays as "Normal" when core dump list is empty.
- Added "Access Control Lists" at Maintenance → Web/SSH Access. [Access Control Lists]
- Added support for HTTPS web access. [HTTPS Web Port][HTTP / HTTPS Web Port ]
- Changed menu "Line Status" in Call Settings to "Lines". [Lines]
- Improved DNS Settings page. [Network Settings – Basic Settings]
- Re-arranged the Setting Status menu. [DP720 Handset Menu]
- Add documents and drilling templates to web GUI support page. [Support]
- Web UI Enhancements
- Improved support for Czech, Dutch, German, Hebrew, Japanese, Korean, Turkish languages.

## Firmware Version 1.0.1.14

- Removed IVR (Interactive Voice Response).
- Hide the content of "Advanced Settings" page when accessing the web GUI with normal user. [Web UI Access Level Management]
- Added voice mail, missed calls, headset icons. [Table 8: DP720 Icons Description]
- Moved Download Config options to Provisioning page. [Provisioning]
- Added Dialing box controls for off-hook dialing on DECT → General Settings. [General Settings]
- Changed EU standard ring tone same as US. [Ring Tones]
- Added support for configurable system ring tone on Settings → Ring Tones. [Ring Tones]
- Added web UI support for packet capture on Maintenance → Packet Capture [Packet Capture].
- Removed "Internal call" from audio ring tone menu.
- Removed "Intercom" feature completely.

## Firmware Version 1.0.1.4

- Added dialing box controls for off-hook dialing on Profile → Call Settings.
- Added Reset handset name to default if handset is unsubscribed.
- Added DHCPv4 Option 120 on Maintenance → Provisioning. [Provisioning]
- Move Network Settings and Phonebook tabs. [Network Settings] [Phonebook Page Definitions]
- Added handset version (firmware) on Status → System Status.
- Web UI Status Enhancements.
- Changed location of handset firmware upload/delete.
- Improved web UI Account Status page.
- Added processing of DHCP option 160 by DHCP client.



- Added support to receive a handset proprietary message when handset power off.
- Added "Off-Hook Auto-Dial " option on DECT → General Settings. [Off-hook Auto-dial]
- Added support to upload handset firmware from web UI. [Handset Firmware]
- Added delete button for uploaded handset firmware via web UI. [Handset Firmware]

### **Firmware Version 1.0.0.16**

- This is the initial version for DP750/DP720.



## GUI INTERFACE EXAMPLES

[http://www.grandstream.com/sites/default/files/Resources/dp750\\_web\\_gui.zip](http://www.grandstream.com/sites/default/files/Resources/dp750_web_gui.zip)

1. Screenshot of Login Page
2. Screenshots of Status Pages
3. Screenshots of Profiles Pages
4. Screenshots of DECT Pages
5. Screenshots of Settings Pages
6. Screenshots of Maintenance Pages
7. Screenshots of Phonebook Pages





## WELCOME

Thank you for purchasing Grandstream DP750 DECT IP Base Station and DP720 DECT Handset.

The DP750 is a powerful DECT VoIP base station that pairs with up to 5 of Grandstream's DP720 DECT handsets to offer mobility to business and residential users. It supports a range of 300 meters outdoors and 50 meters indoors to give users the freedom to move around their work or home space, delivering efficient flexibility. This DECT VoIP base station supports up to 10 SIP accounts and 5 concurrent calls while also offering 3-way voice conferencing, full HD audio and integrated PoE. A shared SIP account on all handsets will add seamless unified features that gives users the ability to answer all calls regardless of location in real-time. The DP750 supports a variety of auto-provisioning methods and TLS/SRTP/ HTTPS encryption security. When paired with Grandstream's DP720, the DP750 offers a powerful DECT VoIP base station that allows any business or residential user to create a cordless VoIP solution.

The DP720 is a DECT cordless VoIP phone that allows users to mobilize their VoIP network throughout any business, warehouse, retail store and residential environment. It is supported by Grandstream's DP750 DECT VoIP base station and delivers a combination of mobility and top-notch telephony performance. Up to five DP720 handsets are supported on each DP750 while each DP720 supports a range of up to 300 meters outdoors and 50 meters indoors from the base station. The DP720 touts a suite of top-notch telephony features including support for up to 10 SIP accounts per handset, full HD audio, a 3.5mm headset jack, multi-language support, a speakerphone and more. When paired with Grandstream's DP750 DECT Base Station, the DP720 offers a powerful DECT VoIP handset that allows any business or residential user to create a cordless VoIP solution.



# PRODUCT OVERVIEW

## Feature Highlights

The following tables contain the major features of the DP750 / DP720:

**Table 1: DP750 Features at a Glance**

<p style="text-align: center;"><b>DP750</b></p> 	<ul style="list-style-type: none"> <li>• 5 handsets.</li> <li>• 10 accounts.</li> <li>• 10 Lines.</li> <li>• 5 Concurrent calls.</li> <li>• PoE power support.</li> <li>• 300m range outdoor / 50m range indoor.</li> </ul>
---	---

**Table 2: DP720 Features at a Glance**

<p style="text-align: center;"><b>DP720</b></p> 	<ul style="list-style-type: none"> <li>• DECT Cordless HD.</li> <li>• 1.8 inch (128x160) TFT color LCD.</li> <li>• 250 hours standby / 20 hours talk time.</li> <li>• 15 languages embedded.</li> <li>• 10 accounts.</li> <li>• 10 lines.</li> <li>• 5 ring modes.</li> </ul>
---	---

## DP750 Technical Specifications

The following table resumes all the technical specifications including the protocols / standards supported, voice codecs, telephony features, languages and upgrade/provisioning settings for the Base station DP750.

**Table 3: DP750 Technical Specifications**

<b>Air Interface</b>	<b>Telephony standards:</b> DECT <b>Frequency bands:</b> <ul style="list-style-type: none"> <li>▪ 1880 – 1900 MHz (Europe), 1920 – 1930 MHz (US)</li> <li>▪ 1910 – 1920 MHz (Brazil), 1786 – 1792 MHz (Korea)</li> <li>▪ 1893 – 1906 MHz (Japan), 1880 – 1895 MHz (Taiwan)</li> </ul> <b>Number of channels:</b> 10 (Europe), 5 (US, Brazil or Japan), 3 (Korea), 8 (Taiwan) <b>Range:</b> up to 300 meters outdoor and 50 meters indoor
<b>Peripherals</b>	5 LED indicators: Power, Network, Register, Call, DECT Reset button, Pairing/Paging button One 10/100 Mbps auto-sensing Ethernet port with integrated PoE
<b>Protocols/Standards</b>	SIP RFC3261, TCP/IP/UDP, RTP/RTCP, HTTP/HTTPS, ARP/RARP, ICMP, DNS (Arecord, SRV, NAPTR), DHCP, PPPoE, SSH, TFTP, NTP, STUN, SIMPLE, LLDP-MED, LDAP, TR-069, 802.1x, TLS, SRTP, IPv6 (pending)
<b>Voice Codecs</b>	G.711 $\mu$ /a-law, G.723.1, G.729A/B, G.726-32, iLBC, G.722, OPUS, G.722.2/AMR-WB (special order), in-band and out-of-band DTMF (in audio, RFC2833, SIP INFO), VAD, CNG, PLC, AJB
<b>Telephony Features</b>	Hold, transfer, forward, 3-way conference, downloadable phonebook (XML, LDAP, up to 3000 entries), call waiting, call log (up to 300 records), auto answer, flexible dial plan, music on hold, server redundancy and fail-over
<b>Sample Applications</b>	Currency (pending)
<b>QoS</b>	Layer 2 QoS (802.1Q, 802.1p) and Layer 3 QoS (ToS, DiffServ, MPLS)
<b>Security</b>	User and administrator level access control, MD5 and MD5-sess based authentication, 256-bit AES encrypted configuration file, TLS, SRTP, HTTPS, 802.1x media access control, DECT authentication & encryption
<b>Multi-language</b>	English, Czech, German, Spanish, French, Arabic, Hebrew, Italian, Russian, Netherlands, Japanese, Polish, Chinese Simple, Chinese Tradition, Korean, Portuguese, Slovakian, Serbian, Swedish and Turkish.
<b>Upgrade/Provisioning</b>	Firmware upgrade via TFTP/HTTP/HTTPS, mass provisioning using TR-069 or AES encrypted XML configuration file
<b>Multiple SIP Accounts</b>	Up to ten (10) distinct SIP accounts per system <b>Each handset</b> may map to any SIP account(s) <b>Each SIP account</b> may map to any handset(s)



<b>Ring Group</b>	Flexible options when multiple handsets share the same SIP account <ul style="list-style-type: none"> <li>▪ <b>Circular Mode:</b> all phones ring sequentially, starting with the phone after the one which rang last.</li> <li>▪ <b>Linear Mode:</b> all phones ring sequentially in the predetermined order, starting with the first phone each time.</li> <li>▪ <b>Parallel Mode:</b> all phones ring concurrently; after one phone answers, the remaining available phones can make new calls</li> </ul>
<b>Power &amp; Green Energy Efficiency</b>	Universal Power Supply Input AC 100-240V 50/60Hz; Output 5VDC, 1A; Micro-USB connection; PoE: IEEE802.3af Class 1, 0.44W–3.84W
<b>Package Content</b>	Base unit, Universal Power Supply, Ethernet cable, Quick Installation Guide, GPL Statement
<b>Dimensions</b>	28.5 mm (H) x 130 mm (W) x 90 mm (D)
<b>Weight</b>	Base unit: 143g, Universal Power Supply: 50g; Package: 360g
<b>Temperature and Humidity</b>	Operation: -10° to 55°C (14 to 131°F); Storage: -20° to 60°C (-4 to 140°F); Humidity: 10% to 90% non-condensing
<b>Compliance</b>	FCC: Part 15D, 47 CFR 2.1093, Part 15B CE: EN60950; EN301489-1-6; EN301406 RCM: AS/NZS60950 ANATEL: #2288-16-9452

## DP720 Technical Specifications

The following table resumes all the technical specifications including the protocols / standards supported, voice codecs, telephony features, languages and upgrade/provisioning settings for the DP720 handset.

**Table 4: DP720 Technical Specifications**

<b>Air Interface</b>	<b>Telephony standards:</b> DECT <b>Frequency bands:</b> <ul style="list-style-type: none"> <li>▪ 1880 – 1900 MHz (Europe), 1920 – 1930 MHz (US)</li> <li>▪ 1910 – 1920 MHz (Brazil), 1786 – 1792 MHz (Korea)</li> <li>▪ 1893 – 1906 MHz (Japan), 1880 – 1895 MHz (Taiwan)</li> </ul> <b>Number of channels:</b> 10 (Europe), 5 (US, Brazil or Japan), 3 (Korea), 8 (Taiwan) <b>Range:</b> up to 300 meters outdoor and 50 meters indoor
<b>Peripherals</b>	1.8 inch (128x160) color TFT LCD 23 keys including 2 softkeys, 5 navigation / menu keys, 4 dedicated function keys for SEND, POWER/END, SPEAKERPHONE, MUTE 3-color MWI LED 3.5mm headset jack Removable belt clip Micro-USB port for alternative charging and non-battery operation



<b>Protocols/Standards</b>	Hearing Aid Compatibility (HAC) compliant
<b>Voice Codecs</b>	G.722 codec for HD audio and G.726 codec for narrow band audio (G.711 $\mu$ -a-law, G.723.1, G.729A/B, iLBC and OPUS are supported via companion DECT base station DP750), AEC, AGC, Ambient noise reduction
<b>Telephony Features</b>	Hold, transfer, forward, 3-way conference, call park, call pickup, downloadable phonebook, call waiting, call log, auto answer, click-to-dial, flexible dial plan, music on hold
<b>Sample Applications</b>	Currency (pending)
<b>HD Audio</b>	Yes, in both Handset and Speakerphone modes
<b>Security</b>	DECT authentication & encryption
<b>Multi-language</b>	English, Czech, German, Spanish, French, Hebrew, Italian, Netherlands, Japanese, Chinese, Chinese simple, Polish, Russian, Chinese Simple, Chinese Tradition, Korean, Portuguese, Slovakian, Serbian, Swedish, Turkish and Arabic.
<b>Upgrade/ Provisioning</b>	Software Upgrade Over-The-Air (SUOTA), handset provisioning Over-The-Air
<b>Multiple Line Access</b>	Each handset may access up to 10 lines
<b>Power &amp; Green Energy Efficiency</b>	Universal Power Supply Input AC 100-240V 50/60Hz; Output 5VDC 1A; Micro-USB connection; Rechargeable 800mAh Ni-MH Low Self-Discharge (LSD) AAA batteries (250 hours of standby time and 20 hours of talk time)
<b>Package Content</b>	Handset unit, universal power supply, charger cradle, belt clip, 2 batteries, Quick Installation Guide
<b>Dimensions (H x W x D)</b>	Handset: 155 x 50 x 26 mm, charger cradle: 35 x 63.5 x 54 mm
<b>Weight</b>	Handset: 138g, charger cradle: 71g, universal power supply: 50g; Package: 360g
<b>Temperature and Humidity</b>	Operation: -10° to 50°C (14 to 122°F); Charging: 0 to 45°C (32 to 113°F); Storage: -20° to 60°C (-4 to 140°F); Humidity: 10% to 90% non-condensing
<b>Compliance</b>	FCC: Part 15D; 47 CFR 2.1093 & IEEE1528-2013, Part68, Part 15B CE: EN60950; EN301489-1-6; EN301406; EN50360; EN62209-1 RCM: AS/NZS60950; AS/ACIF S004 ANATEL: #2288-16-9452



## GETTING STARTED

This chapter provides basic installation instructions including the list of the packaging contents and also information for obtaining best performance with the DP720 IP DECT phone and its base station DP750.

### Equipment Packaging

**Table 5: Equipment Packaging**

DP720	DP750
<ul style="list-style-type: none"> <li>• 1 Handset unit</li> <li>• 1 Universal power supply 5V</li> <li>• 1 Charger cradle</li> <li>• 1 Belt clip</li> <li>• 2 Rechargeable batteries</li> <li>• 1 Quick Installation Guide</li> </ul>	<ul style="list-style-type: none"> <li>• 1 Base unit</li> <li>• 1 Universal power supply 5V</li> <li>• 1 Ethernet cable</li> <li>• 1 Quick Installation Guide</li> <li>• 1 GPL Statement</li> </ul>

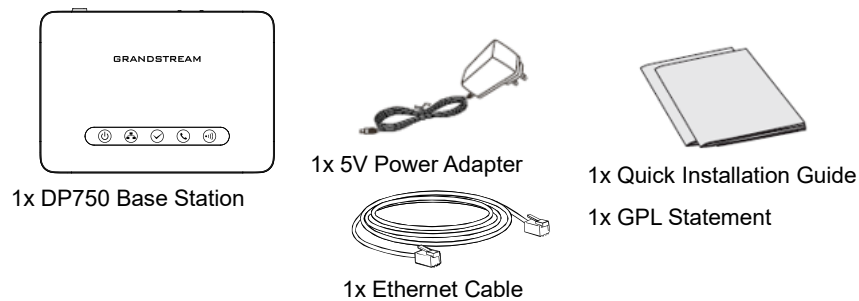

**Figure 1: DP750 Package Content**

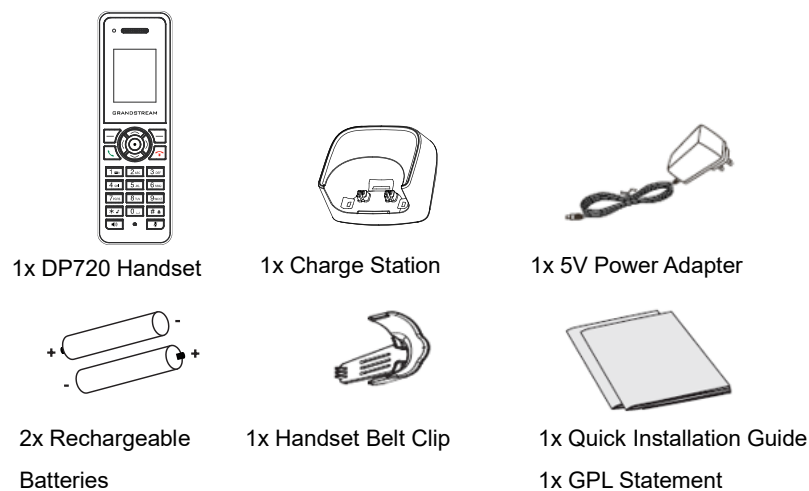
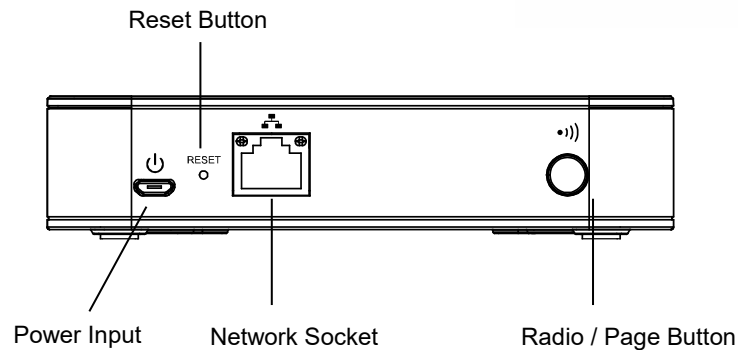

**Figure 2: DP720 Package Content**

**Note:** Check the package before installation. If you find anything missing, contact your system administrator.

## Connecting DP750

To setup the DP750 Base Station, please follow the steps below:



**Figure 3: DP750 Back View**

You have two options for power and network connection of the base station: AC power or Power over Ethernet (PoE).

**Note:** For better signal range, we recommend to install DP750 horizontally with LED side facing toward the usage area. For example, if you just put it on a desk, the LED better face up, if you mount it on the ceiling, it better LED face down, in both cases, it toward the space area.

### Connecting via AC power

1. Connect the micro-USB connector into the related port on the base station and connect the other end of the power adapter into an electrical power outlet.
2. Connect the supplied Ethernet cable between the Internet port on the base station and the Internet port in your network or the switch/hub device port.

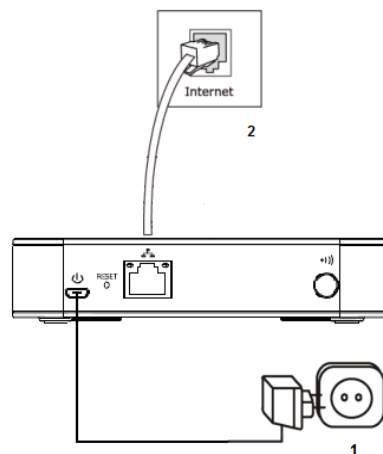

**Figure 4: Connecting the Base station**

### Connecting via PoE

To connect the base station using PoE, you need to connect the Ethernet cable provided (or 3rd party network cable) between the Network Socket on the base station to Ethernet port of your PoE switch/hub.

## Setting up DP720 handset

Please follow below steps to insert batteries into the handset:

1. Open the battery compartment cover.
2. Insert the batteries in the correct polarity.
3. Close the battery compartment cover.

**Note:** Please charge the batteries fully before using the handset for the first time

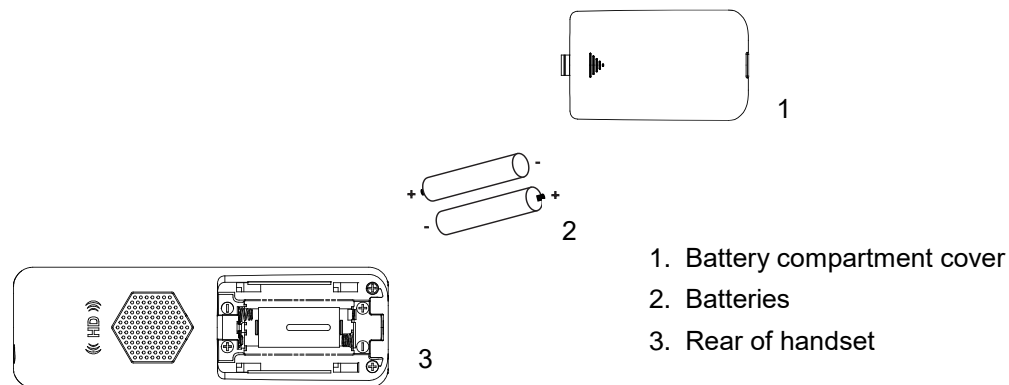

Figure 5: Setting up the DP720

## Battery Information

- **Technology:** Nickel Metal Hydride (Ni-MH)
- **Size:** AAA
- **Voltage:** 1.2V
- **Capacity:** 800mAh
- **Charging time:** 12 hours from empty to full
- **Standby time:** up to 250 hours
- **Talk time:** up to 20 hours' active talk time

In order to get the best performance of your DP720 handset, we recommend using original batteries provided in the package or batteries compliant with above specifications.

The specifications may differ depending on the age and capacity of the batteries used.

**Important Note:** Be careful when inserting the batteries into your handset to avoid any risk of short-circuit, which lead to damage your batteries and/or the handset itself. Do not use damaged batteries which can increase the risk of serious harm.



## Setting up the Charge Station

Please refer to the following steps for setting up the charge station and charging the handset:

1. Connect the DC plug on the power adapter to the micro-USB connector on the charge station.
2. Connect the other end of the power adapter into an electrical power outlet.
3. After setting up the handset and the charge station, place the handset in the charge station.

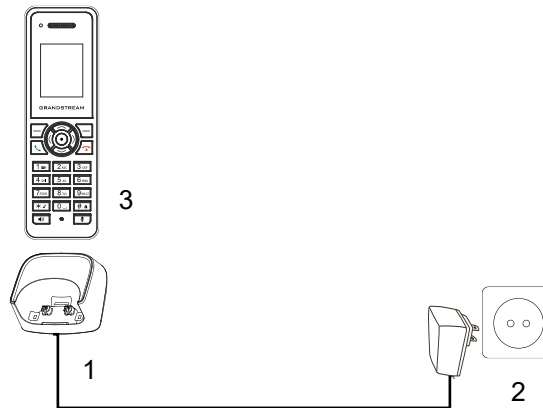







Figure 6: Setting up the charge station

## DP750 LED Patterns

The DP750 has 5 LED lights on it. Please refer to the following table for the meaning of each light.

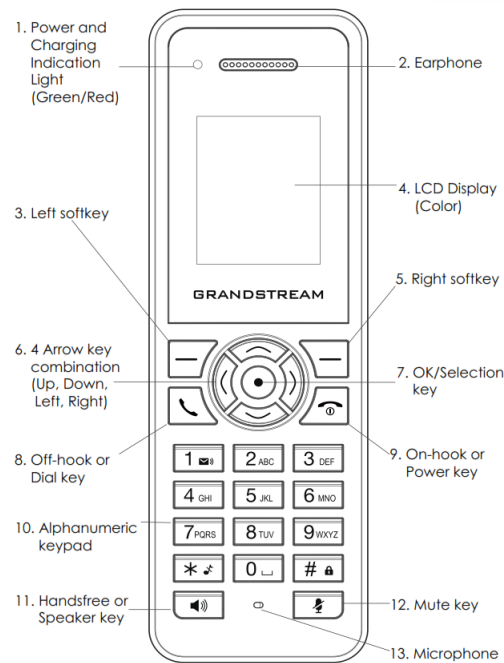

Table 6: DP750 LED Patterns

LED Light	Status
	Indicates Power ON/OFF.
	Indicates access to the network. Remains ON while there is access to the network.
	Indicates if a SIP account is registered.
	Indicates status of the lines. <b>Blinking:</b> A line is in use. <b>Solid ON:</b> All lines are free.
	The Radio icon for pairing the DP720 and DP750; when holding the Radio button, blinking indicates a pairing attempt.

## DP720 Handset Description

The LCD screen and the Keypad are the main hardware components of the DP720.



**Figure 7: Handset Keys Description**

**Table 7: Keypad Keys Description**















	Key	Description
1.	<b>Power and Charging Indication Light</b>	<b>Red:</b> Charging. <b>Green:</b> Charge completed. <b>Blinking:</b> Missed call(s) or Voice Mail received.
2.	<b>Earphone</b>	Delivers audio output.
3,5	<b>Left and Right softkeys</b>	Correspond to functions displayed on the LCD. These functions change depending on the current context.
4.	<b>LCD Display</b>	Shows call information, handset status icons, prompt messages, etc.
6.	<b>4 Arrow key combination</b>	Allows navigation of the cursor through the displayed menu options.
7.	<b>OK/Selection key</b>	Selects the option chosen by the cursor. (Enters the main menu from the home screen.)
8.	<b>Off-hook / Dial key</b>	Enters dialing mode, or dials number entered.
9.	<b>On-hook / Power key</b>	Terminates calls or turns the handset on / off.
10.	<b>Alphanumeric Keypad</b>	Provides the digits, letters, and special characters in context-sensitive applications. For + sign, press and hold key 0.
11.	<b>Hands-free/Speaker key</b>	Switches between Handset and Hands-free / Speaker modes.
12.	<b>Mute key</b>	Activates or Deactivates the Mute feature.
13.	<b>Microphone</b>	Picks up audio earpiece and hands-free calls.























## DP720 Icons Description

The following table contains description of each icon that might be displayed on the LCD screen of the DP720 handset.

**Table 8: DP720 Icons Description**

	<b>Battery status</b> Not equipped with battery
	<b>Battery status</b> Battery empty
	<b>Battery status</b> Battery low
	<b>Battery status</b> Battery normal
	<b>Battery status</b> Battery full
	<b>Battery status</b> Charging
	<b>Signal status</b> Not subscribed
	<b>Signal status</b> Not in range
	<b>Signal status</b> Signal very low
	<b>Signal status</b> Signal low
	<b>Signal status</b> Signal normal
	<b>Signal status</b> Signal good
	<b>Signal status</b> Signal very good
	<b>Microphone MUTE Status</b> OFF - Not muted ON – Muted

	<b>Speaker status</b> OFF - Speaker is inactivated ON - Speaker is activated
	<b>Headset icon</b>
	<b>Missed Call icon</b>
	<b>Voicemail icon</b>
	<b>Ringtone status</b> OFF - Ringtone off (Silent mode) ON - Ringtone on
	<b>Keypad Lock status</b> OFF - Keypad unlock ON - Keypad locked
	<b>Incoming Call notification</b>
	<b>Outgoing Call notification</b>
	<b>SRTP Outgoing Call notification</b>
	<b>SRTP Incoming Call notification</b>
	<b>Missed Call notification</b>
	<b>Incoming Call notification</b>
	<b>Outgoing Call notification</b>
	<b>Voicemail notification</b>
	<b>Contacts</b>
	<b>Call History</b>
	<b>Voice Mail</b>
	<b>Settings</b>
	<b>Call Settings</b>
	<b>Status</b>

## DP720 Handset Menu

The handset has an easy-to-use menu structure. Every menu opens a list of options. To open the main menu, press “Menu” (left softkey) when the handset is on and in standby mode. Press Arrow keys to navigate to the menu option you require. Then press “Select” (left softkey) or **OK/Selection key** to access further options or confirm the setting displayed. To go to the previous menu item, press “Back” (right softkey). You can press **Power** key at any time to cancel and return to standby mode. If you do not press any key, the handset automatically reverts to standby mode after 20 seconds.

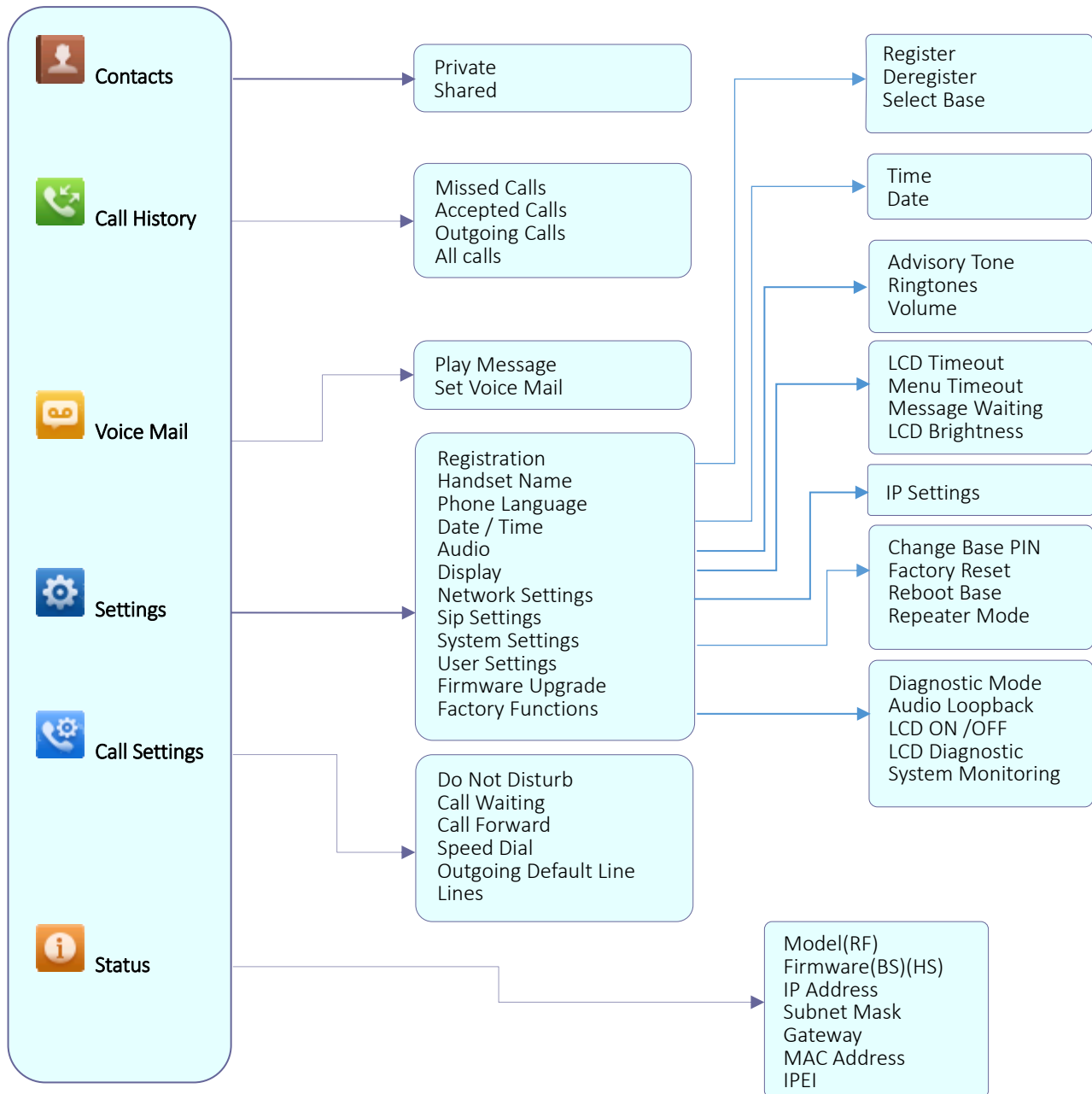

Figure 8: DP720 Menu Structure



<b>Contacts</b>	<ul style="list-style-type: none"> <li>• <b>Private:</b> Private contacts include contacts visible in the current handset only. You can add, edit, delete, and call all the entries in private contacts.</li> <li>• <b>Shared:</b> Shared contacts are the contacts shared between the handsets subscribed to the DP750 base station. You can add, edit, delete, edit and call all the entries in shared contacts as well.</li> </ul>
<b>Call History</b>	Display the call history: <b>Missed Calls</b> , <b>Accepted Calls</b> , <b>Outgoing Calls</b> or <b>All Calls</b> . You can add contacts to <b>Shared Contacts</b> directly from call logs.
<b>Voice Mail</b>	<ul style="list-style-type: none"> <li>• <b>Play Message:</b> Play voice mail messages received.</li> <li>• <b>Set Voice Mail:</b> Configure voice mail parameters.</li> </ul>
<b>Settings</b>	<ul style="list-style-type: none"> <li>• <b>Registration</b> Register and unregister your handset and also select base station.</li> <li>• <b>Handset Name</b> Change the handset's name.</li> <li>• <b>Phone Language</b> Select the language to be displayed on the phone's LCD. (Default is English.)</li> <li>• <b>Date/Time</b> Configure date and time on the Handset.</li> <li>• <b>Audio</b> Specify ringtones for internal/external calls, the volume, and advisory tones (Keypad, Confirmation, Low battery notifications).</li> <li>• <b>Display</b> Configure backlight, LCD timeout, LCD brightness and menu key timeout.</li> <li>• <b>Network Settings</b> Configure IP addresses and select DHCP/Static IP mode.</li> <li>• <b>SIP Settings</b> Configure/View SIP accounts settings.</li> <li>• <b>System settings</b> Change Base PIN code, perform factory reset, reboot base and configure repeater mode.</li> <li>• <b>User Settings</b> Configure auto answer feature, off-cradle pickup, on-cradle hang-up, busy tone, call waiting tone, cradle backlight, onhook backlight, mute, SIP account display, arrow keys functions, and left / right soft keys function.</li> <li>• <b>Firmware Upgrade</b> Upgrade the firmware version of the handset.</li> </ul>



	<ul style="list-style-type: none"> <li>• <b>Factory Functions</b> <ul style="list-style-type: none"> <li>• <i>Diagnostic Mode</i> All LEDs will light up, and the LCD will display a table listing the names of all keys in red. Press any key to diagnose; the key's name will display in blue. After all keys are diagnosed, a prompt message ("PASS") will display; press "Back" (right softkey) to exit.</li> <li>• <i>Audio Loopback</i> Speak to the phone using speaker/handset/headset. If you can hear your voice, your audio is working fine. Press "Exit" softkey to exit audio loopback mode.</li> <li>• <i>LCD ON / OFF</i> Select this option to turn off LCD. Press any button to turn on LCD.</li> <li>• <i>LCD Diagnostic</i> Select this option to enter LCD Diagnostic mode. Press "Next" (left softkey) to display white screen. Continue pressing the left softkey to view all remaining screens (black, blue, red, and green) and then exit. End the test early by pressing the right softkey.</li> <li>• <i>System Monitoring</i> Displays RSSI and battery voltage information.</li> </ul> </li> </ul>
<b>Call Settings</b>	<ul style="list-style-type: none"> <li>• <b>Do Not Disturb</b> Enable/disable do not disturb mode on the phone.</li> <li>• <b>Call Waiting</b> Configure call waiting feature.</li> <li>• <b>Call Forward</b> Configure call forward feature.</li> <li>• <b>Speed Dial</b> Assign contact numbers as speed dial.</li> <li>• <b>Outgoing Default Line</b> Select outgoing default line.</li> <li>• <b>Lines</b> Display the line status.</li> </ul>
<b>Status</b>	<ul style="list-style-type: none"> <li>• <b>Status</b> Display handset status (Model RF, Firmware, IP address, Subnet mask, Gateway, MAC Address, IPEI, ...)</li> </ul>



## CONFIGURATION GUIDE





The DP750 can be configured using:

- Web GUI embedded on the DP750 using PC's web browser.
- LCD Configuration Menu using the paired DP720 keypad.

Via Web GUI you can configure all the functions supported by the DP750; while via paired DP720, you can access limited configuration and need the base station PIN code for some options.

### Obtain DP750 Base Station IP Address via paired DP720

DP750 is by default configured to obtain IP address from DHCP server where the unit is located. In order to know which IP address is assigned to your DP750, please follow below steps using a paired DP720 handset with your DP750 base station. Please see [Register DP720 Handset to DP750 Base Station](#) .

1. Press "Menu" (left softkey)  or **OK** button  on DP720 to view operation menu.
2. Press Arrow (Up, Down, Left, Right) keys to move the cursor to **Status** icon  , then press "Select" (left softkey)  or **OK** button .

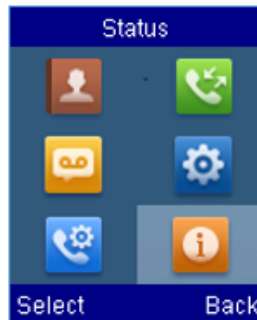

3. Using Arrow keys, navigate down to view the IP address of the DP750.





## Configuration via Web Browser

The DP750 embedded Web server responds to HTTP/HTTPS GET/POST requests. Embedded HTML pages allow a user to configure the DP750 through a Web browser such as Google Chrome, Mozilla Firefox and Microsoft's IE.

### Accessing the Web UI

1. Connect the computer to the same network as DP750.
2. Make sure the DP750 is booted up.
3. You may check DP750 IP address via a subscribed DP720 on its LCD menu at: **Status → IP Address**. Please see [Obtain DP750 Base station IP Address via paired DP720](#)
4. Open Web browser on your computer.
5. Enter the DP750's IP address in the address bar of the browser.
6. Enter the administrator's username and password to access the Web Configuration Menu.

**Note:** The computer must be connected to the same sub-network as the DP750. This can be easily done by connecting the computer to the same hub or switch as the DP750.

### Web GUI Languages

Currently the DP750 series web GUI supports English, Czech, German, Spanish, French, Arabic, Hebrew, Italian, Russian, Netherlands, Japanese, Polish, Chinese Simple, Chinese Tradition, Korean, Portuguese, Slovakian, Serbian, Swedish and Turkish

Users can select the displayed language in web GUI login page, or at the upper right of the web GUI after logging in



Figure 9: DP750 Web GUI Language

## Icons Bar Shortcut

Users can find the icon bar right below the main menu of every page as displayed on following screenshot:

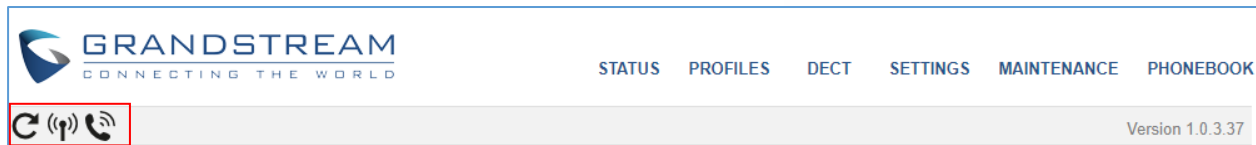

Figure 10: Icons Bar Shortcut

Please refer to following table describing the use of each icon:



Icon	Description
	<b>Refresh Button:</b> Allows users to refresh the current page.
	<b>Subscribe Button:</b> Allows users to open the subscription.
	<b>Paging Button:</b> Allows users to page all the registered DP720 handsets.

Figure 11: Icons Bar Description

## Saving the Configuration Changes

After users makes changes to the configuration, pressing the **Save** button will save but not apply the changes until the **Apply** button on the top of web GUI page is pressed. Users can instead directly press the **Save and Apply** button. We recommend rebooting or powering cycle the phone after applying all the changes.

## Web UI Access Level Management

There are two default passwords for the login page:

User Level	Username	Password	Web Pages Allowed
End User Level	user	123	Only Status, Settings and Maintenance
Administrator Level	admin	admin	All pages

The password is case sensitive with maximum length of 25 characters.

**Note:** When accessing the web GUI with normal user level, "Advanced Settings" page will be hidden.

When changing any settings, always SUBMIT them by pressing the **Save** or **Save and Apply** button on the bottom of the page. If using the **Save** button, after making all the changes, click on the **Apply** button on top of the page to submit. After submitting the changes in all the Web GUI pages, reboot DP750 to have the changes take effect if necessary; most of the options under the **Settings** page require reboot, but options under the **Accounts** and **Phonebook** pages do not.



## Changing User Level Password

1. Access the Web GUI of your DP750 using the admin's username and password. (Default username and password is: admin/admin).
2. Press **Login** to access your settings.
3. Go to **Maintenance → Web/SSH Access**.
4. In **Web/SSH Access** page, locate **User Password** section:
  - a. Type in your new user password in **New Password** field.
  - b. Type in again same entered password in **Confirm Password** field.
5. Press **Save and Apply** to save your new setting.

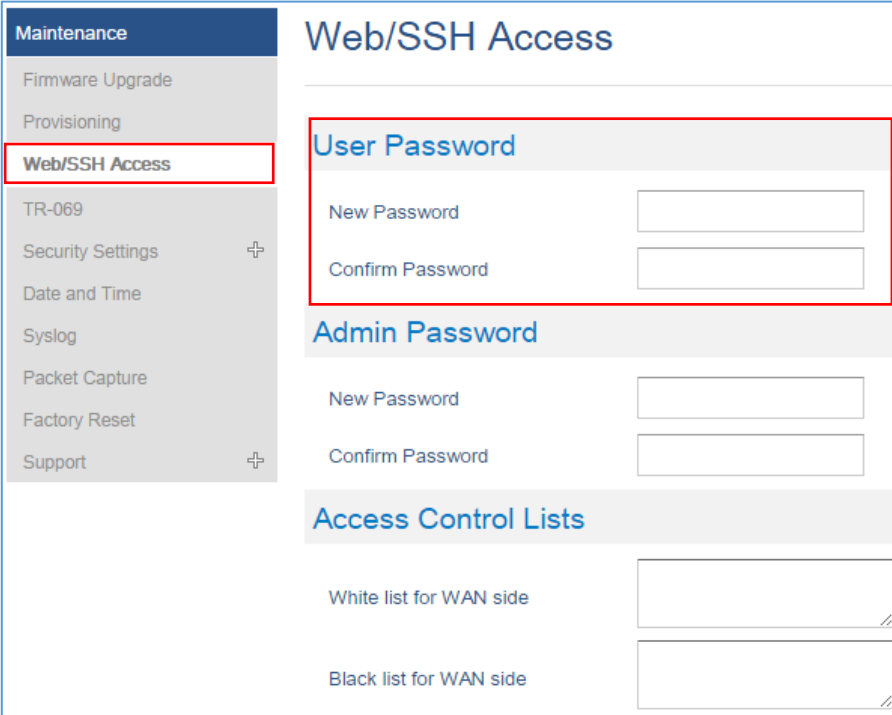

The screenshot shows the 'Web/SSH Access' configuration page. On the left is a navigation menu with 'Web/SSH Access' selected. The main content area has three sections: 'User Password', 'Admin Password', and 'Access Control Lists'. The 'User Password' section contains two input fields: 'New Password' and 'Confirm Password'. The 'Admin Password' section also has 'New Password' and 'Confirm Password' fields. The 'Access Control Lists' section has two text areas: 'White list for WAN side' and 'Black list for WAN side'.

**Figure 12: User Level Password**

**Note:** DO NOT USE same password for both user and admin accounts.

## Changing Admin Level Password

1. Access the Web GUI of your DP750 using the admin's username and password. (Default username and password is: admin/admin).
2. Press **Login** to access your settings.
3. Go to **Maintenance → Web/SSH Access**.
4. In **Web/SSH Access** page, locate **Admin Password** section:



- a. Type in your new Admin Password in **New Password** field.
  - b. Type in again same entered password in **Confirm Password** field.
5. Press **Save and Apply** to save your new setting.

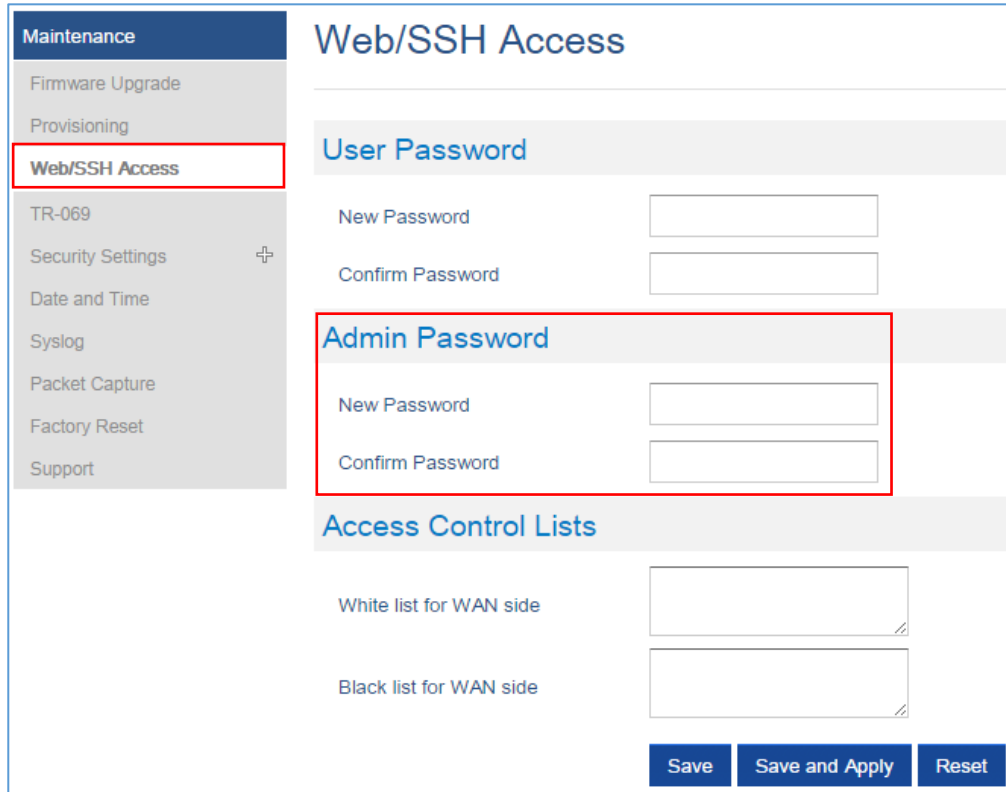

**Figure 13: Admin Level Password**

**Note:** DO NOT USE same password for both user and admin accounts.

### Changing HTTP / HTTPS Web Access Port

1. Access the Web GUI of your DP750 using the admin's username and password. (Default username and password is: admin/admin).
2. Press **Login** to access your settings.
3. Go to **Maintenance** → **Security Settings** → **Web/SSH**.
4. In **Web/SSH Settings** page, locate **HTTP / HTTPS Web Port** field and change it to your desired/new HTTP / HTTPS port.  
**Note:** By default, the HTTP port is 80 and HTTPS is 443.
5. Select the **Web Access Mode** depending on desired protocol (HTTP or HTTPS).
6. Press **Save and Apply** to save your new setting.

**Note:** A reboot is required for this change to take effect.



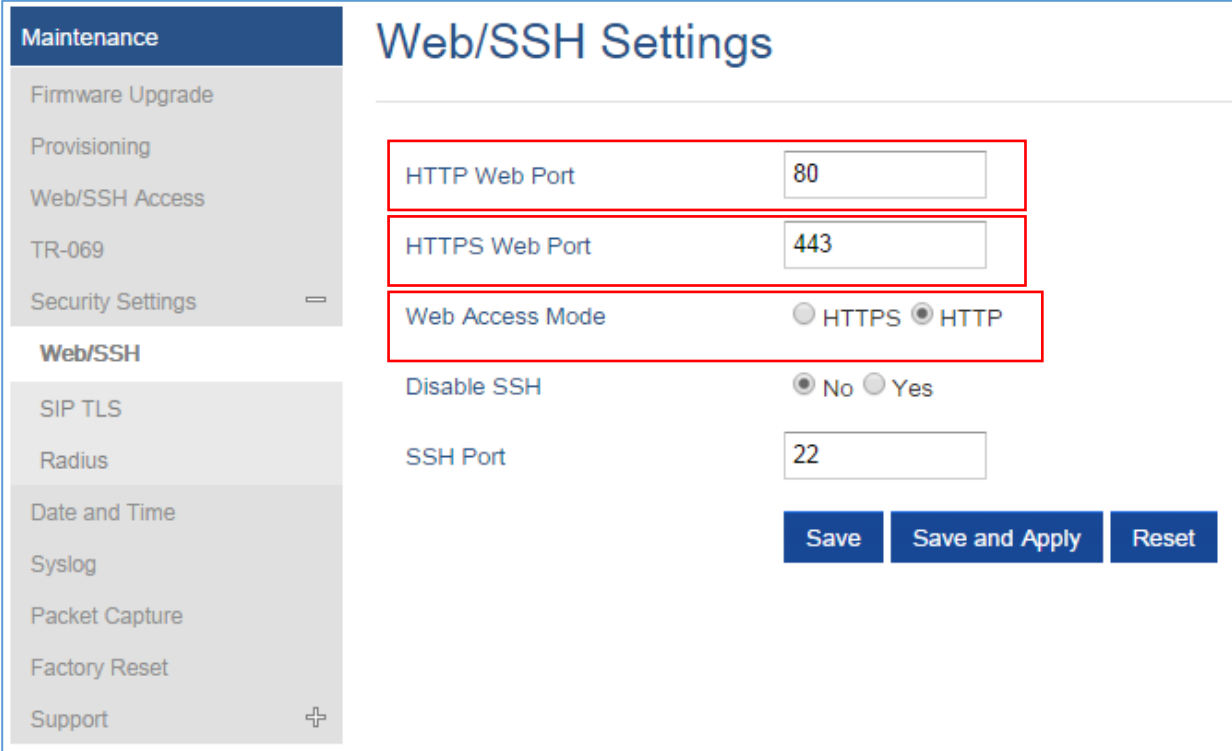

Maintenance

Web/SSH Settings

Firmware Upgrade  
 Provisioning  
 Web/SSH Access  
 TR-069  
 Security Settings -

Web/SSH

SIP TLS  
 Radius  
 Date and Time  
 Syslog  
 Packet Capture  
 Factory Reset  
 Support +

HTTP Web Port

HTTPS Web Port

Web Access Mode

 HTTPS
  HTTP

Disable SSH

 No
  Yes

SSH Port

Save
Save and Apply
Reset

Figure 14: Web Access Port







## Web Configuration Definitions

This section describes the options in the DP750 Web UI. As mentioned, you can log in as an administrator or an end user.





- **Status:** Display system info, network status, base and repeater status, account status, and line options.
- **Profiles:** Configure the profiles with general settings, network settings, SIP settings, audio settings, call settings and ring tones.
- **DECT:** Configure DECT general settings, account settings and handset line settings.
- **Settings:** Configure ring tones and system features.
- **Maintenance:** Configure networks, upgrading and provisioning, web/SSH access, TR-069, security settings, date and time, and syslog.
- **Phonebook:** Manage phonebooks: global/shared (XML or LDAP) and private (XML).

## Status Page Definitions

Table 9: Status Page Definitions

Account Status	
<b>Account</b>	Displays list of configured accounts' names, from Account 1 to Account 10.
<b>SIP User ID</b>	Displays list of SIP user id registered.
<b>SIP Server</b>	Displays list of SIP Server.
<b>SIP Registration</b>	Shows the status of SIP registration. If the SIP account is successfully registered, it will display "YES" with green background. If the SIP account is not registered, it will display "NO" with red background.
<b>HS Mode</b>	Displays the HS mode configured for each account.
<b>HS status table</b>	<p>Illustrates both handsets and SIP accounts statuses. Each column is dedicated to one HS; each row shows the status of the account on that HS:</p> <ul style="list-style-type: none"> <li> <b>Gray:</b> HS is not configured to use this account.</li> <li> <b>Green:</b> HS is idle on this account.</li> <li> <b>Green Blinking:</b> HS is using this account.</li> <li> <b>Red:</b> HS is not available.</li> <li> <b>Red/Orange Blinking:</b> HS is ringing on this account.</li> <li> <b>Brown:</b> The line is configured, but the handset is not subscribed.</li> </ul> <p>For example, if accounts 1, 3 and 4 are assigned to HS3 with account 3 in use, the column for HS3 will have cell 3 with red icon, cells 1 and 4 with green icon, and cells 2 and 5 with gray icon.</p>
DECT Base Status	
<b>Base Station Name</b>	Displays name of base station. Default is <b>DP750_[last 6 digit of MAC address]</b> .
<b>Base DECT FW Version</b>	Shows firmware version of base DECT.
<b>Base DECT RF Region</b>	Indicates region of base DECT RF.
<b>Base DECT RFPI Address</b>	Specifies DECT RFPI (Radio Fixed Part Identity) address which is a unique identity for the base.
<b>Global Functions</b>	<ul style="list-style-type: none"> <li>- <b>Unsubscribe Handsets:</b> Unsubscribes all handsets from DECT base station.</li> <li>- <b>Upgrade Handsets:</b> Upgrade all handsets from DECT base station.</li> </ul>



<b>Handset Status</b>	<ul style="list-style-type: none"> <li>• <b>Handset Name:</b> Displays index and name (customizable) of each handset.</li> <li>• <b>IPEI:</b> Indicates IPEI number of each handset; this is the unique identity for the handset. If the handset is in range, the IPEI will be displayed with a green background, otherwise, it will be displayed with a red background.</li> <li>• <b>Battery icon</b>  : Illustrates battery status for each Handset; it can be either:             <ul style="list-style-type: none"> <li> <b>Fully charged</b></li> <li> <b>Not fully charged</b></li> <li> <b>Low, needs to be charged or replaced</b></li> <li> <b>Charging</b></li> </ul> </li> <li>• <b>Page:</b> Sends paging request to corresponding handset, which will receive incoming ring tone and “Paging” will be displayed on their LCD screens; this function helps you locate the handsets.</li> <li>• <b>Unsubscribe:</b> Unsubscribes corresponding handset from DECT base station.</li> <li>• <b>HS Firmware:</b> Indicates handset’s firmware version number.</li> <li>• <b>Upgrade:</b> Shows handset upgrade status or trigger handset upgrade process.</li> <li>• <b>RAM Dump:</b> Notifies when a debug file is available after recovery.</li> <li>• <b>Note:</b> The DECT page status keeps refreshing automatically and periodically to update the information about the registered handsets.</li> </ul>
-----------------------	--

## DECT Repeater Status

<b>Paired Devices</b>	<p>Displays paired repeaters showing:</p> <ul style="list-style-type: none"> <li>• <b>Model:</b> Displays model of repeater.</li> <li>• <b>Name:</b> Displays the name of the repeater.</li> <li>• <b>IP address:</b> Displays the DECT repeater IP address.</li> <li>• <b>MAC address:</b> Displays the DECT repeater MAC address.</li> <li>• <b>Status:</b> Displays the status of DECT Repeater:             <ul style="list-style-type: none"> <li>• <b>Online</b> when the repeater is turned on and ready for use.</li> <li>• <b>Offline</b> when the repeater is turned off.</li> </ul> </li> <li>• <b>Signal Strength:</b> Display link status and signal strength, different status is available (excellent, good, week and poor) depending on the distance between the repeater and base station.</li> <li>• <b>Active Calls:</b> Displays number of active calls.</li> <li>• <b>Unlink:</b> Click on <b>Unlink</b> button to disconnect the DECT Repeater from the base station.</li> </ul>
<b>Discovered Devices</b>	<p>Displays discovered repeaters using:</p> <ul style="list-style-type: none"> <li>• <b>Model:</b> Displays model of repeater.</li> <li>• <b>Name:</b> Displays the name of the repeater.</li> <li>• <b>IP address:</b> Displays the DECT repeater IP address.</li> <li>• <b>MAC address:</b> Displays the DECT repeater MAC address.</li> <li>• <b>Link:</b> Clicks <b>Link</b> button to connect DECT Repeater to the base station.</li> </ul>



Line Options	
<b>Account</b>	Displays list of configured accounts' names, from Account 1 to Account 10.
<b>SIP User ID</b>	Displays list of SIP user id registered.
<b>DND</b>	Shows DND (Do Not Disturb) feature status (per SIP account).
<b>Forward</b>	Indicates destination to which all incoming calls will be forwarded (per SIP account).
<b>Busy Forward</b>	Indicates destination to which incoming calls will be forwarded when the line is busy (per SIP account).
<b>Delayed Forward</b>	Indicates destination to which incoming calls will be forwarded if the call is not answered within a specified period of time or number of rings (per SIP account).
Network Status	
<b>MAC Address</b>	Shows Device ID in hexadecimal format. This is needed by network administrators for troubleshooting. The MAC address will be used for provisioning and can be found on the label on original box and on the label located on the bottom panel of the device.
<b>IP Address Mode</b>	Indicates used IP address mode: DHCP, Static IP or PPPoE.
<b>IP Address</b>	Displays assigned IP address. Example: 192.168.5.110
<b>Subnet Mask</b>	Displays assigned subnet mask. Example: 255.255.255.0
<b>Gateway</b>	Displays assigned default gateway. Example: 192.168.5.1
<b>PPPoE Link Up</b>	Indicates PPPoE connection status.
<b>DNS Server 1</b>	Shows assigned DNS server address 1. Example: 8.8.8.8
<b>DNS Server 2</b>	Shows assigned DNS server address 2. Example: 8.8.4.4
<b>NAT Traversal</b>	Indicates type of NAT for each Profile. (Based on STUN protocol.)
System Info	
<b>Product Model</b>	Displays product model info. Default is <b>DP750</b> .
<b>Part Number</b>	Shows product part number. Example: 9610003814A (last 2 digits show HW version, in this example 14A for HW version 1.4A)
<b>Software Version</b>	<ul style="list-style-type: none"> <li>• <b>Firmware Status:</b> Displays the status of the firmware loaded.</li> <li>• <b>Boot:</b> Specifies Boot version.</li> <li>• <b>Core:</b> Specifies Core version.</li> </ul>





	<ul style="list-style-type: none"> <li>• <b>Base:</b> Specifies Base version.</li> <li>• <b>Prog:</b> Specifies Prog version. This is the main firmware release number, which is always used for identifying the software system of the DP750.</li> <li>• <b>Locale:</b> Specifies Locale version.</li> <li>• <b>Recovery:</b> Specifies Recovery version.</li> <li>• <b>Handset:</b> Specifies Handset firmware version.</li> </ul>
<b>System Up Time</b>	Indicates system uptime since last reboot.
<b>System Time</b>	Shows actual time and date according to your configuration.
<b>Service Status</b>	Reveals status of VoIP applications.

## Profiles Page Definitions

Table 10: Profiles Page Definitions

General Settings	
<b>Profile Active</b>	Activates or deactivates SIP profile.
<b>Profile Name</b>	Determines the name of the profile, this profile name can also be used in handset config provisioning for validation. By default, the values are profile 1 – profile 4.
<b>SIP Server</b>	Configures SIP server IP address or domain name provided by VoIP service provider. This is the primary SIP server used to send/receive SIP messages from/to DP750.
<b>Failover SIP Server</b>	Specifies failover SIP server IP address or domain name provided by VoIP service provider. This server will be used if the primary SIP server becomes unavailable.
<b>Prefer Primary SIP Server</b>	Prefers primary SIP server. The profile will register to primary Server if registration with Failover server expires. Default is <b>No</b> .
<b>Outbound Proxy</b>	Specifies IP address or domain name of outbound proxy, media gateway or session border controller. Used by DP750 for firewall or NAT penetration in different network environments. If symmetric NAT is detected, STUN will not work and only outbound proxy can correct the problem.
<b>Voice Mail Access Number</b>	Defines the voice mail portal access number to allow users accessing their voice messages.
Network Settings	
<b>Layer 3 QoS Settings</b>	Defines Diff-Serv values for SIP and RTP. Defaults are: SIP Diff-Serv: <b>24</b> ; RTP Diff-Serv: <b>46</b>



<b>DNS Mode</b>	<p>Selects DNS mode to use for the client to look up server. One mode can be chosen.</p> <ul style="list-style-type: none"> <li>• <b>A Record:</b> resolves IP Address of target according to domain name.</li> <li>• <b>SRV:</b> DNS SRV resource records indicate how to find services for various protocols.</li> <li>• <b>NAPTR/SRV:</b> Naming Authority Pointer according to RFC 2915.</li> <li>• <b>Use Configured IP:</b> If selected, please fill in Primary IP, Backup IP 1 and Backup IP 2 to be used for server look up.</li> </ul> <p>Default is <b>A Record</b>.</p>
<b>Primary IP</b>	Specifies primary IP address where the base sends DNS query to, when “Use Configured IP” is selected for DNS mode.
<b>Backup IP 1</b>	Specifies backup IP 1 address where the base sends DNS query to, when “Primary IP” is not responding.
<b>Backup IP 2</b>	Specifies backup IP 2 address where the base sends DNS query to, when “Backup IP 1” is not responding.
<b>NAT Traversal</b>	<p>Enables/disables NAT traversal mechanism. If activated (by choosing “STUN”) and a STUN server is also specified (<b>Maintenance</b> → <b>Network Settings</b> → <b>STUN Settings</b>); the base performs according to STUN client specification. Under this mode, embedded STUN client will detect if and what type of firewall/NAT is being used. If detected NAT is a Full Cone, Restricted Cone, or a Port-Restricted Cone, the base will use its mapped public IP address and port in all of its SIP and SDP messages. If NAT Traversal field is set to “Keep Alive”, the base will periodically (every 20 seconds) send a blank UDP packet (with no payload data) to SIP proxy to keep the “ping hole” on the NAT open.</p>
<b>Use NAT IP</b>	Defines NAT IP address used in SIP/SDP messages. It should only be used if required by ITSP.
<b>Proxy-Require</b>	Determines a SIP Extension to notify the SIP server that the base is behind a NAT/Firewall.

### SIP Settings – Basic Settings

<b>SIP transport</b>	Selects transport protocol for SIP packets; UDP or TCP or TLS. Make sure your SIP server or network environment supports SIP over the selected transport method. Default is <b>UDP</b> .
<b>SIP Registration</b>	Controls whether to send SIP REGISTER messages to the proxy server. Device may not be able to make/receives calls if disabled. Default is <b>Yes</b> .



<b>Unregister on Reboot</b>	Controls whether to clear SIP user's information by sending un-register request to the proxy server. The un-registration is performed by sending a REGISTER message with "Contact" header set to * and Expires=0 parameters to the SIP server. This will unregister all SIP accounts under concerned Profile. Default is <b>No</b> .
<b>Add Auth Header on Initial REGISTER</b>	Adds "Authentication" header with blank "nonce" attribute in the initial SIP REGISTER request. Default is <b>No</b> .
<b>Outgoing Calls Without Registration</b>	Enables the ability to place outgoing calls even when not registered (if allowed by ITSP); device will not be able to receive incoming calls. Any HS member of a hunting group that is not registered with a SIP account, will be able to place outbound calls using the SIP credentials of the primary hunting group HS.  <u>For example:</u> HS 1, 3 and 5 are members of the same Hunting Group. HS 1 is registered with a SIP account. HS 3 and 5 are not registered. HS 3 and 5 will be able to place outbound calls using the SIP account of HS 1, even if <b>Outgoing Call without Registration</b> is set to No. Default is <b>No</b> .
<b>Register Expiration</b>	Refreshes registration periodically with specified SIP proxy (in minutes). Maximum interval is 65535 minutes (about 45 days). Default is <b>60</b> minutes (or 1 hour).
<b>SIP Registration Failure Retry Wait Time</b>	Sends re-register request after specific time (in seconds) when registration process fails. Maximum interval is 3600 seconds (1 hour). Default is <b>20</b> seconds.
<b>SIP Registration Failure Retry Wait Time upon 403 Forbidden</b>	Sends re-register request after specific time (in seconds) when registration process fails due to "403 Forbidden". Valid range is 0 to 3600 in second. 0 second means stop retry registration. Default is <b>1200</b> seconds.
<b>Reregister Before Expiration</b>	Sends re-register request after specific time (in seconds) to renew registration before the previous registration session expires.
<b>Local SIP Port</b>	Defines local port to use by the base for listening and transmitting SIP packets. Default value for Profile 1 is 5060, 6060 for Profile 2, 7060 for Profile 3 and 8060 for Profile 4.
<b>Use Random SIP Port</b>	Controls whether to use configured or random SIP ports. This is usually necessary when multiple base stations are behind the same NAT. Default is <b>No</b> .
<b>Local RTP Port</b>	Defines local RTP port used to listen and transmit RTP packets. Default is <b>5004</b> .
<b>SIP T1 Timeout</b>	Defines T1 timeout value. It is an estimate of the round-trip time between the client and server transactions. For example, the base station will attempt to send a request to a SIP server. The time it takes between sending out the request to the point of getting a response is the SIP T1 timer. If no response is received the timeout



	is increased to (2*T1) and then (4*T1). Request re-transmit retries would continue until a maximum amount of time defined by T2. Default is <b>0.5</b> seconds.
<b>SIP T2 Timeout</b>	Identifies maximum retransmission interval for non-INVITE requests and INVITE responses. Retransmitting and doubling of T1 continues until it reaches T2 value. Default is <b>4</b> seconds.
<b>SIP Timer D</b>	Configures SIP timer D defined in RFC3261. Range of values 0-64. Default is <b>0</b> .
<b>Enable OPTIONS Keep Alive</b>	Enables OPTIONS Keep Alive, to check SIP server. Default is <b>No</b> .
<b>OPTIONS Keep Alive Interval</b>	Time interval for OPTIONS Keep Alive feature in seconds. Range of values is 1–64800. Default is <b>30</b> .
<b>OPTIONS Keep Alive Max Lost</b>	Maximum number of lost packets for OPTIONS Keep Alive feature before the phone sends a re-registration. Range of values 3-10. Default is <b>3</b> .
<b>Remove OBP from Route Header</b>	Removes outbound proxy information from “Route” header when sending SIP packets. Default is <b>No</b> .
<b>Support SIP Instance ID</b>	Adds “SIP Instance ID” attribute to “Contact” header in REGISTER request as defined in IETF SIP outbound draft. Default is <b>No</b> .
<b>Hold Target Before Refer</b>	Sends re-INVITE to hold transfer target before sending REFER message to transferee. Default is <b>Yes</b> .
<b>Refer-To Use Target Contact</b>	Includes target’s “Contact” header information in “Refer-To” header when using attended transfer. Default is <b>No</b> .
<b>SUBSCRIBE for MWI</b>	Sends periodic “SUBSCRIBE” requests (depends on “Register Expiration” parameter) for message waiting indication service. Default is <b>No</b> .
<b>Enable 100rel</b>	Appends “100rel” attribute to the “required” header of the initial signaling messages. Default is <b>No</b> .
<b>TEL URI</b>	<p>Indicates E.164 number in “From” header by adding “User=Phone” parameter or using “Tel:” in SIP packets, if the base has an assigned PSTN Number.</p> <ul style="list-style-type: none"> <li>• <b>Disabled:</b> Will use “SIP User ID” information in the Request-Line and “From” header.</li> <li>• <b>User=Phone:</b> “User=Phone” parameter will be attached to the Request-Line and “From” header in the SIP request to indicate the E.164 number. If set to “Enable”.</li> <li>• <b>Enabled:</b> “Tel:” will be used instead of “sip:” in the SIP request.</li> </ul> <p>Please consult your carrier before changing this parameter. Default is <b>Disabled</b>.</p>



<b>Do Not Escape '#' as %23 in SIP URI</b>	Replaces “#” by “%23” when sending SIP packets. Default is <b>No</b> .
<b>Disable Multiple m Line in SDP</b>	Sends only one m line in SDP, regardless of how many m fields are in the incoming SDP. Default is <b>No</b> .
<b>Use Privacy Header</b>	Adds “Privacy” header if special feature is set to “Default”, and not “CBCOM”.
<b>Use P-Preferred-Identity Header</b>	Adds “PPI” header if special feature is set to “Default”, and not “CBCOM”.
<b>Ignore Alert-Info Header</b>	This option is used to configure default ringtone. If set to “Yes”, configured default ringtone will be played. The default setting is <b>No</b> .
<b>Use MAC Header</b>	<p>This option specifies to whether add MAC address to SIP messages or no. The option can be set to:</p> <ul style="list-style-type: none"> <li>• <b>No:</b> If set to “No”, MAC address will not be added to SIP messages in the User-Agent header.</li> <li>• <b>Yes except REGISTER:</b> If selected, MAC address will be included in all SIP messages sent from the base station except for SIP REGISTER messages used to register/unregister accounts.</li> <li>• <b>Yes to all SIP:</b> If selected, MAC address will be included in all SIP messages sent from the base station without exceptions.</li> </ul> <p><b>Example of User-Agent Header including MAC address:</b>  <i>User-Agent: Grandstream DP750 1.0.4.10 000b828708a5</i></p> <p>Default setting is <b>No</b>.</p>

## SIP Settings - Session Timer

<b>Session Expiration</b>	Enables periodic refresh of SIP session via a SIP request (UPDATE, or re-INVITE). When the session interval expires and there is no refresh via an UPDATE or re-INVITE message, the session will be terminated. Session Expiration is the time at which the session is considered timed out, if no successful session refresh transaction occurs beforehand. Default is <b>180</b> seconds.
<b>Min-SE</b>	Defines Minimum session expiration (in seconds). Default is <b>90</b> seconds.
<b>Caller Request Timer</b>	Uses session timer when making outbound calls if remote party supports it. Default is <b>No</b> .



<b>Callee Request Timer</b>	Uses session timer when receiving inbound calls with session timer request. Default is <b>No</b> .
<b>Force Timer</b>	Uses session timer even if the remote party does not support this feature. Selecting “No” will enable session timer only when the remote party supports it. Default is <b>No</b> . To turn off Session Timer, select “No” for Caller Request Timer, Callee Request Timer, and Force Timer.
<b>UAC Specify Refresher</b>	Specifies which end will act as refresher for outgoing calls: <ul style="list-style-type: none"> <li>• <b>UAC</b>: The base station acts as the refresher.</li> <li>• <b>UAS</b>: Callee or proxy server act as the refresher.</li> </ul> Default is <b>Omit</b>
<b>UAS Specify Refresher</b>	Specifies which end will act as refresher for incoming calls: <ul style="list-style-type: none"> <li>• <b>UAS</b>: The base station acts as the refresher.</li> <li>• <b>UAC</b>: Callee or proxy server act as the refresher.</li> </ul> Default is <b>Omit</b>
<b>Force INVITE</b>	Uses INVITE message to refresh the session timer. Default is <b>No</b> .

### SIP Settings - Security Settings

<b>Validate Incoming Messages</b>	Defines whether incoming messages will be validated or not. Default is <b>No</b> .
<b>Check SIP User ID for Incoming INVITE</b>	Checks SIP User ID in the Request URI of incoming INVITE; if it doesn't match the base SIP User ID, the call will be rejected. Direct IP calling will also be disabled. Default is <b>No</b> .
<b>Accept Incoming SIP from Proxy Only</b>	Checks SIP address of the Request URI in the incoming SIP message; if it doesn't match SIP server address of the account, the call will be rejected. Default is <b>No</b> .
<b>Authenticate Incoming INVITE</b>	Challenges the incoming INVITE for authentication with SIP 401 Unauthorized message. Default is <b>No</b> .
<b>Authenticate Server Certificate Domain</b>	Checks server TLS certificate to ensure that common name matches the configured SIP server. Default is <b>No</b> .
<b>Authenticate Server Certificate Chain</b>	Checks server TLS certificate to ensure that it is authorized by a known certificate authority. Default is <b>No</b> .
<b>Trusted CA Certificate</b>	Treats entered certificate as a valid CA for authenticating the server TLS certificate. Default is <b>No</b> .



Audio Settings	
<b>Send DTMF</b>	<p>Specifies the mechanism to transmit DTMF digits. There are 3 supported modes:</p> <ul style="list-style-type: none"> <li>• <b>In audio:</b> which means DTMF is combined in the audio signal (not very reliable with low-bit-rate codecs);</li> <li>• <b>Via RTP (RFC2833):</b> permits to specify DTMF with RTP packet. Users could know the packet is DTMF in the RTP header as well as the type of DTMF;</li> <li>• <b>SIP INFO:</b> uses SIP INFO to carry DTMF. The defect of this mode is that it's easily to cause desynchronized of DTMF and media packet for the reason the SIP and RTP are transmitted respectively.</li> </ul> <p>Default is <b>via RTP (RFC2833)</b></p>
<b>Disable DTMF Negotiation</b>	<p>Uses above DTMF order without negotiation. Default is <b>No</b>.</p>
<b>DTMF Payload Type</b>	<p>Defines payload type for DTMF using RFC2833.</p>
<b>Preferred Vocoder</b>	<p>Configures vocoders in a preference list (up to 8 preferred vocoders) that will be included with same order in SDP message. Vocoder types are G.711 A-/U-law, G.722, G.726-32, G.723, G.729, iLBC and OPUS</p>
<b>Voice Frames per TX</b>	<p>Transmits a specific number of voice frames per packet. Default is <b>2</b>; increases to 10/20/32/64 for G711/G726/G723/other codecs respectively.</p>
<b>G723 Rate</b>	<p>Operates at specified encoding rate for G.723 vocoder. Available encoding rates are 6.3kbps or 5.3kbps. Default is <b>6.3kbps</b>.</p>
<b>G726-32 Packing Mode</b>	<p>Defines G726-32 packing mode ("ITU" or "IETF"). Default is <b>ITU</b>.</p>
<b>iLBC Frame Size</b>	<p>Specifies iLBC packet frame size (20ms or 30ms). Default is <b>20ms</b>.</p>
<b>iLBC Payload type</b>	<p>Determines payload type for iLBC. The valid range is between 96 and 127. Default is <b>97</b>.</p>
<b>Disable OPUS stereo in SDP</b>	<p>Disables OPUS stereo attribute in SDP header. Default is <b>No</b>.</p>
<b>OPUS Payload Type</b>	<p>Determines OPUS payload type. The valid range is between 96 and 127. Default is <b>125</b>.</p>
<b>Use First Matching Vocoder in 200OK SDP</b>	<p>Includes only the first matching vocoder in its 200OK response, otherwise it will include all matching vocoders in same order received in INVITE. Default is <b>No</b>.</p>



<b>SRTP Mode</b>	Selects SRTP mode to use (“Disabled”, “Enabled but not forced”, or “Enabled and forced”). Default is <b>Disabled</b> . It uses SDP security description to exchange key. Please refer to: <b>SDES:</b> <a href="https://tools.ietf.org/html/rfc4568">https://tools.ietf.org/html/rfc4568</a> <b>SRTP:</b> <a href="https://tools.ietf.org/html/rfc3711">https://tools.ietf.org/html/rfc3711</a>
<b>Crypto Life Time</b>	Adds crypto life time header to SRTP packets. Default is <b>Yes</b> .
<b>Silence Suppression (VAD)</b>	Allows detecting the absence of audio and conserves bandwidth by preventing the transmission of "silent packets" over the network. Default is <b>No</b> .
<b>Jitter Buffer Type</b>	Selects jitter buffer type (Fixed or Adaptive) based on network conditions.
<b>Jitter Buffer Length</b>	<ul style="list-style-type: none"> <li>• <b>High</b> (initial 200ms, min 40ms, max 600ms) Note: not all vocoders can meet the high requirement.</li> <li>• <b>Medium</b> (initial 100ms, min 20ms, max 200ms).</li> <li>• <b>Low</b> (initial 50ms, min 10ms, max 100ms).</li> </ul>
<b>Enable RTCP</b>	Enables RTCP statistics and control information. Default settings is <b>RTCP</b> .
<b>Call Settings</b>	
<b>Early Dial</b>	Sends an early INVITE each time a key is pressed when a user dials a number. Otherwise, only one INVITE is sent after full number is dialed (user presses <b>Dial Key</b> or after “no key entry timeout” expires). This option should be used only if there is a SIP proxy configured and supporting “484 Incomplete Address” responses. Otherwise, the call will likely be rejected by the proxy (with a 404 Not Found error). Default is <b>No</b> . <i><u>This feature is NOT designed to work with and should NOT be enabled for direct IP-to-IP calling.</u></i>
<b>Dial Plan Prefix</b>	Adds specified prefix to dialed number.
<b>Dial Plan</b>	<b>Dial Plan Rules:</b> <ol style="list-style-type: none"> <li>1. Accept Digits: +,1,2,3,4,5,6,7,8,9,0, *, #, A,a,B,b,C,c,D,d ;</li> <li>2. Grammar: <b>x</b> – any digit from 0-9;           <ol style="list-style-type: none"> <li>a. <b>xx+</b> - at least 2-digit number;</li> <li>b. <b>xx</b> – exactly 2-digit number;</li> <li>c. <b>^</b> - exclude;</li> <li>d. <b>.</b> – wildcard, matches one or more characters</li> <li>e. <b>[3-5]</b> – any digit of 3, 4, or 5;</li> <li>f. <b>[147]</b> – any digit 1, 4, or 7;</li> <li>g. <b>&lt;2=011&gt;</b> - replace digit 2 with 011 when dialing</li> </ol> </li> </ol>





- h. **<=1>** - add a leading 1 to all numbers dialed, vice versa will remove a 1 from the number dialed
- i. **|** - or

- **Example 1:** {[369]11 | 1617xxxxxxx} –  
Allow 311, 611, 911, and any 10-digit numbers of leading digits 1617
  - **Example 2:** {^1900x+ | <=1617>xxxxxxx} –  
Block any number with leading digits 1900 and add prefix 1617 for any dialed 7-digit numbers
  - **Example 3:** {1xxx[2-9]xxxxxx | <2=011>x+} –  
Allow any length of number with leading digit 2 and 10 digit-numbers of leading digit 1 and leading exchange number between 2 and 9; If leading digit is 2, replace leading digit 2 with 011 before dialing.
3. Default: Outgoing – {x+}

Example of a simple dial plan used in a Home/Office in the US:

```
{ ^1900x. | <=1617>[2-9]xxxxxx | 1[2-9]xx[2-9]xxxxxx | 011[2-9]x. | [3469]11 | \+x+ }
```

**Explanation** of example rule (reading from left to right):

- **^1900x.** – prevents dialing any number started with 1900
- **<=1617>[2-9]xxxxxx** - allows dialing to local area code (617) numbers by dialing 7 numbers and 1617 area code will be added automatically
- **1[2-9]xx[2-9]xxxxxx** - allows dialing to any US/Canada Number with 11 digits length
- **011[2-9]x.** – allows international calls starting with 011
- **[3469]11** – allow dialing special and emergency numbers 311, 411, 611 and 911
- **\+x+** - allow dialing any digit with leading + sign; example: +16175669300

**Note:** In some cases, user wishes to dial strings such as \*123 to activate voice mail or other application provided by service provider. In this case \* should be predefined inside dial plan feature. An example dial plan will be: { \*x+ } which allows the user to dial \* followed by any length of numbers.

**Use # as Dial Key**

Treats “#” as the “Send” (or “Dial”) key. If set to “No”, this “#” key can be included as part of the dialed number. Default is **Yes**.



<b>Match Incoming Caller ID</b>	<p>Specifies matching rules with number, pattern or Alert Info text. When the incoming caller ID or Alert Info matches the rule, the phone will ring with selected distinctive ringtone. Matching rules:</p> <ul style="list-style-type: none"> <li>• <b>Specific caller ID number.</b> For example, 8321123;</li> <li>• <b>A defined pattern</b> with certain length using x and + to specify, where x could be any digit from 0 to 9. Samples: <ul style="list-style-type: none"> <li>▪ <b>xx+</b> : at least 2-digit number;</li> <li>▪ <b>xx</b> : only 2-digit number;</li> <li>▪ <b>[345]xx</b>: 3-digit number with the leading digit of 3, 4 or 5;</li> <li>▪ <b>[6-9]xx</b>: 3-digit number with the leading digit from 6 to 9.</li> </ul> </li> <li>• <b>Alert Info text</b></li> </ul> <p>Users could configure the matching rule as certain text (e.g., priority) and select the custom ring tone mapped to it. The custom ring tone will be used if the phone receives SIP INVITE with Alert-Info header in the following format:  <i>Alert-Info: &lt;http://127.0.0.1&gt;; info=priority</i></p> <p>Selects the distinctive ring tone for the matching rule. When the incoming caller ID or Alert Info matches the rule, the phone will ring with the selected ring.</p>
<b>Allow Auto Answer by Call-info</b>	<p>If set to "Yes", the phone will automatically turn on the speaker phone to answer incoming calls, based on the SIP info header sent from the server/proxy. The default setting is "<b>No</b>"</p>
<b>Custom Call-Info for Auto Answer</b>	<p>Used exclusively to match the contents of the info parameter in the Call-Info header for auto answer.  The default auto answer headers will not be matched if this is defined.</p>
<b>No Key Entry Timeout</b>	<p>Initiates the call within this time interval if no additional key entry during dialing stage. Default is <b>4</b> seconds.</p>
<b>Off-Hook Auto-Dial Delay</b>	<p>Waits for specified time (in seconds) after off-hook before autodialing the preconfigured number. The range is 0 to 60 seconds.</p>
<b>Enable Call Features</b>	<p>Enables do not disturb, call forward and other call features via the local feature codes on the base. Otherwise, ITSP feature codes can be used.  Default is <b>Yes</b>.</p>
<b>Disable Call Waiting Caller ID</b>	<p>Disables displaying caller ID when receiving a second incoming call.  Default is <b>No</b>.</p>
<b>Enable Call Waiting in Parallel Mode</b>	<p>Enables call waiting for accounts using this profile which are set to Parallel ring mode. Default is <b>No</b>.</p>



<b>Disable Visual MWI</b>	Disables use of visual message waiting indicator when there is an unread voicemail message. Default is <b>No</b> .
<b>Transfer on Conference Hang-up</b>	Transfers the call to the other party if the conference initiator hangs up. Default is <b>No</b> .
<b>Ring Timeout</b>	Stops ringing when incoming call is not answered within a specific period of time. Default is <b>60</b> seconds.
<b>Hunting Group Ring Timeout</b>	Forwards incoming call to the next member of a hunt group if not answered within a specific period of time. Default is <b>20</b> seconds.
<b>Send Anonymous</b>	Sets "From", "Privacy" and "P_Asserted_Identity" headers in outgoing INVITE message to "anonymous", blocking caller ID. Default is <b>No</b> .
<b>Anonymous Call Rejection</b>	Rejects incoming calls with anonymous caller ID with "486 Busy here" message. Default is <b>No</b> .
<b>Special Feature</b>	Selects Soft switch vendors' special mode. Example of vendors: Broadsoft, CBCOM, RNK, Huawei, ZTE IME, Phone Power, Metaswitch. Default is <b>Standard</b> .

## DECT Page Definitions

Table 11: DECT Page Definitions

General Settings	
<b>Base Station Name</b>	Displays the name of the base station. Default is <b>DP750[last 6 digits of MAC address]</b> .
<b>Admin PIN Code</b>	Configures admin PIN code for authentication. Default is <b>0000</b> .
<b>Enable Repeater Mode</b>	Enables the base station repeater mode to associate with available repeaters. Once enabled the base station starts searching for nearby repeaters and open subscription to associate with the available repeaters. This option requires rebooting the base station to take effect. Default is <b>No</b> . <b>Note:</b> Grandstream's repeater is not officially released.
<b>Enable Repeater Management</b>	Enables base station network management of discovered and paired repeaters. Once enabled, users need first to reboot the base station to take effect, then login on the web UI and browser to Status page, a new tab " <b>DECT Repeater Status</b> " will be available to display discovered and paired devices and also allowing users to associate / dissociate repeaters and also access their web GUI. Default is <b>No</b> .



<b>Clear Call Logs</b>	Deletes call history logs of all handsets from base station.	
<b>Handset Settings</b>	<b>Handset</b>	Displays list of handsets' indexes, from HS 1 to HS 5.
	<b>Handset Name</b>	Allows to customize handset name. Default is "HS1" to "HS5"
	<b>Handset Phonebook</b>	Assigns private phonebook to handset. Each handset has a private phonebook or can be disabled. A private phonebook can be shared between specific handsets. <b>Example:</b> PB1 assigned to HS1 and HS2
	<b>Off-hook Auto-dial</b>	Configures a number to auto dial when off-hook.
<b>SIP Account Settings</b>		
<b>Account</b>	Displays list of accounts' indexes, from account 1 to account 10.	
<b>SIP User ID</b>	Enters SIP user ID provided by VoIP service provider (ITSP). Usually in the form of digit similar to phone number or actually a phone number.	
<b>Authenticate ID</b>	Enters account authenticate ID provided by VoIP service provider (ITSP). Can be identical to or different from "SIP user ID".	
<b>Password</b>	Specifies account password provided by VoIP provider (ITSP) to register to SIP servers.	
<b>Name</b>	Chooses a name to be associated to user.	
<b>Profile</b>	Selects the profile ID (1/2/3/4).	
<b>HS Mode</b>	<p>Determines HS modes; the base station supports 4 hunting group modes and 1 non-hunting group:</p> <ul style="list-style-type: none"> <li>• <b>Circular mode:</b> all phones ring sequentially, starting with the phone after the one which rang last.</li> <li>• <b>Linear mode:</b> all phones ring sequentially in the predetermined order, starting with the first phone each time.</li> <li>• <b>Parallel mode:</b> all phones ring concurrently; after one phone answers, the remaining available phones can make new calls</li> <li>• <b>Non-Hunting Group:</b> an account will be assigned to a single specific handset.</li> </ul> <p>For more details about Hunting Group, please refer to [Hunting Groups].</p>	



<b>Active</b>	Activates/deactivates the account.
<b>Handset Line Settings</b>	
<b>Handset Line Settings</b>	<p>Configures handset line settings; the base station supports up to 10 SIP accounts, 5 handsets; each Handset can be configured with up to 10 accounts.</p> <p>Please be aware that the handset line settings will be affected by DID settings (hunting group settings) in “DECT → SIP Account Settings”. For more details about Hunting Group, please refer to [Hunting Groups].</p>
<b>Handset Settings (1,5)</b>	
<b>Disable Private Phonebook</b>	Enables / disables private phonebook access on this handset. Default setting is <b>No</b> .
<b>Enable Auto Answer</b>	Enables / disables auto answer of incoming calls to handset. Default setting is <b>No</b> .
<b>Enable Off hook on Cradle Pickup</b>	Enables / disables off hook of handset when picked up from cradle. Default setting is <b>No</b> .
<b>Enable on hook on Cradle Reposition</b>	Enables / disables on hook of handset when repositioned on cradle. Default setting is <b>No</b> .
<b>Disable Conference</b>	Enables / disables the conference option on this handset. Default setting is <b>No</b> .
<b>Disable Transfer</b>	Enables / disables transfer option on this handset. Default setting is <b>No</b> .
<b>Disable Busy Tone on Remote Disconnect</b>	Enables / disables the busy tone heard in the handset when call is disconnected remotely.
<b>Disable Call Waiting Tone</b>	Disables playing call waiting tone during active call when receiving a second incoming call. The CWCID will still be displayed. Default is <b>No</b> .
<b>Custom Ringtone</b>	Assigns custom ringtone to specific handset from the ringtones available on the base station. It takes up to 10 ringtone files which have be named as ring1.bin to ring10.bin, and you can assign one ringtone to each handset. Default is <b>Disabled</b> .
<b>Time Format</b>	Set the displayed Time Format on handsets to 12 hours or 24 hours. Default is <b>12hr</b> .
<b>Date Format</b>	Set the displayed Date Format on handsets.



## Settings Page Definitions

Table 12: Settings Page Definitions

Network Settings – Basic Settings		
<b>IP Address Mode</b>	Selects IP address mode (DHCP, Static IP or PPPoE) for DP750 Base Station.	
<b>Preferred DNS Server</b>	Specifies preferred DNS server to use when DHCP, PPPoE or Static mode is set.	
<b>DHCP Settings</b>	<b>Host name (Option 12)</b>	Specifies the name of the client. The name may or may not be qualified with the local domain name. This field is optional but may be required by ISP.
	<b>Vendor Class ID (Option 60)</b>	Exchanges vendor class ID by clients and servers to convey particular configuration or other identification information about a client. Default is <b>DP7XX</b> .
<b>PPPoE Settings</b>	Configures PPPoE account ID, password and service name.	
<b>Static IP Settings</b>	Sets IP address, subnet mask, gateway, DNS server 1, and DNS server 2.	
Network Settings – Advanced Settings		
<b>802.1X Mode</b>	Enables/Disables 802.1X mode. To enable this mode, you should select EAP-MD5. Default is <b>Disable</b> .	
<b>802.1X Identity</b>	Configures the identity for 802.1X mode.	
<b>MD5 Password</b>	Determines the MD5 password for 802.1X mode.	
<b>802.1X CA Certificate</b>	Uploads / deletes the 802.1X CA certificates.	
<b>802.1X Client Certificate</b>	Uploads / Deletes the 802.1X Client Certificates.	
<b>Enable LLDP</b>	Activates LLDP (Link Layer Discovery Protocol). Default is <b>No</b> .	
<b>Layer 2 QoS Settings</b>	<b>Enable VLAN</b>	Enables / Disables the VLAN mode. Default is <b>Disabled</b> .
	<b>Layer 2 QoS 802.1Q/VLAN Tag</b>	Sets layer 2 QoS 802.1Q/VLAN tag. Default is 0.
	<b>Layer 2 QoS 802.1p Priority</b>	Sets layer 2 QoS 802.1p priority value for SIP signaling. Default is <b>0</b> .



	<b>Value for SIP signaling</b>	
	<b>Layer 2 QoS 802.1p Priority Value for RTP media</b>	Sets layer 2 QoS 802.1p priority value for RTP media. Default is <b>0</b> .
<b>STUN Settings</b>	<b>Use STUN</b>	Enables STUN. Default is <b>No</b> .
	<b>STUN server</b>	Configures IP address or domain name of STUN server. Only non-symmetric NAT routers work with STUN.
	<b>Number of STUN Response Misses Allowed</b>	Specifies number of STUN response misses allowed before restarting DHCP service. The minimum is <b>3</b> misses.
	<b>Keep-Alive Interval</b>	Sends periodically a blank UDP packet to SIP server to keep "ping hole" on the NAT router open. Default is <b>20</b> seconds.
<b>UPnP Discovery Settings</b>	<b>Enable UPnP discovery</b>	Enables/disables UPnP discovery feature. Default is <b>Yes</b> . After enabled, if you have a PC in the same network of DP750, you can browse it directly in your Network. Double click the device will open its web GUI in your default browser.
	<b>UPnP discovery notify interval</b>	Specifies in seconds the interval to send out SSDP notifies. Default settings is <b>30</b> .
<b>Network → Open VPN® Settings</b>		
<b>OpenVPN® Enable</b>	Enables/Disables the OpenVPN® feature. Default settings is <b>No</b> .	
<b>OpenVPN® Server Address</b>	Configures the address of the OpenVPN® server.	
<b>OpenVPN® Port</b>	Defines the port of the OpenVPN® server. Default is <b>1194</b> .	
<b>OpenVPN® Transport</b>	Determines network protocol UDP or TCP used for OpenVPN®. Default is <b>UDP</b> .	
<b>OpenVPN® CA</b>	Uploads the OpenVPN® CA.	
<b>OpenVPN® Certificate</b>	Uploads the OpenVPN® Certificate.	
<b>OpenVPN® Client Key</b>	Uploads the OpenVPN® Client Key.	



<b>OpenVPN® Cipher Method</b>	Must be the same cipher method used by the OpenVPN® server
<b>OpenVPN® Username</b>	OpenVPN® authentication username (optional)
<b>OpenVPN® Password</b>	OpenVPN® authentication password (optional)
<b>Ring Tones</b>	
<b>System Ring Cadence</b>	Sets ring cadences for all incoming calls. Syntax: <b>c=on1/off1-on2/off2-on3/off3;</b> on1 is the period of ringing ("On time" in "ms") while off1 is the period of silence. Default is set to c=2000/4000; (US standards). Up to three cadences are supported.
<b>Call Progress Tones</b>	Configures tone frequencies according to user preference. By default, the tones are set to North American frequencies. Frequencies should be configured with known values to avoid uncomfortable high pitch sounds. ON is the period of ringing ("On time" in "ms") while OFF is the period of silence. In order to set a continuous ring, OFF should be zero. Otherwise it will ring ON ms and a pause of OFF ms and then repeats the pattern. <ul style="list-style-type: none"> <li>• "Dial tone"</li> <li>• "Ring back tone"</li> <li>• "Busy tone"</li> <li>• "Call-Waiting tone"</li> </ul> Please refer to the document below to determine your local call progress tones: <a href="http://www.itu.int/ITU-T/inr/forms/files/tones-0203.pdf">http://www.itu.int/ITU-T/inr/forms/files/tones-0203.pdf</a>
<b>System Features</b>	
<b>Disable Direct IP Call</b>	Deactivates Direct IP-to-IP calling function. Default is <b>No</b> .
<b>User-Agent Prefix</b>	This option allows to configure a customized User-Agent Prefix.

## Maintenance Page Definitions

Table 13: Maintenance Page Definitions

<b>Firmware Upgrade</b>	
<b>Firmware Upgrade and Provisioning</b>	Selects how firmware upgrade request will be sent: "Always Check for New Firmware", "Check New Firmware only when F/W pre/suffix changes", or "Always Skip the Firmware Check".





<b>HTTP/HTTPS User Name</b>	Enters user name to authenticate with HTTP/HTTPS server.
<b>HTTP/HTTPS Password</b>	Enters password to authenticate with HTTP/HTTPS server.
<b>Always send HTTP Basic Authentication Information</b>	Includes configured user name and password in HTTP request before receiving authentication challenge from the server. Default is <b>No</b> .
<b>Verify host when using HTTPS</b>	Verifies host name in server certificate when using HTTPS. Default is <b>Yes</b> .
<b>Upgrade via</b>	Selects firmware upgrade method: TFTP, HTTP or HTTPS.
<b>Firmware Server Path</b>	Sets IP address or domain name of firmware server. The URL of the server that hosts the firmware release. Default is <b>fm.grandstream.com/gs</b> . <b>Note:</b> Make sure to not prepend address with "http://" or any other protocol.
<b>Firmware File Prefix</b>	Checks if firmware file is with matching prefix before downloading it. This field enables user to store different versions of firmware files in one directory on the firmware server.
<b>Firmware File Postfix</b>	Checks if firmware file is with matching postfix before downloading it. This field enables user to store different versions of firmware files in one directory on the firmware server.
<b>Allow DHCP Option 43 and Option 66 to Override Server</b>	Obtains configuration and upgrade server's information from DHCP server using options 66 and 43. <b>Note:</b> If DHCP Option 66 is enabled, the base will attempt downloading the firmware file from the server URL provided by DHCP, even though <b>Firmware Server Path</b> is left blank.
<b>Automatic Upgrade</b>	Specifies when the firmware upgrade process will be initiated; there are 4 options: <ul style="list-style-type: none"> <li>• <b>Yes, check for upgrade at random every X days:</b> User needs to specify a period in days.</li> <li>• <b>No:</b> Base station will only do upgrade once at boot up.</li> <li>• <b>Check every X minutes:</b> User needs to specify a period in minutes.</li> <li>• <b>Check every day:</b> User needs to specify "Hour of the day (0-23)".</li> <li>• <b>Check every week:</b> User needs to specify "Hour of the day (0-23)" and "Day of the week (0-6)". <b>Note:</b> Day of week is starting from Sunday.</li> </ul> Default is <b>No</b> .



<b>Firmware Key</b>	Decrypts the firmware file using specified key (32-digit in Hexadecimal) when encrypted.	
<b>Handset Firmware</b>	<b>Upload</b>	Uploads handset firmware. Reboot the device after uploading to apply and use the new firmware.
	<b>Delete</b>	Deletes previously uploaded handset firmware.
	<b>Automatic Upgrade</b>	Enables automatic upgrade when the handset detects the new firmware.
<b>Provisioning</b>		
<b>XML Config File Password</b>	Decrypts XML configuration file when encrypted. The password used for encrypting the XML configuration file is using OpenSSL.	
<b>HTTP/HTTPS User Name</b>	Enters user name to authenticate with HTTP/HTTPS server.	
<b>HTTP/HTTPS Password</b>	Enters password to authenticate with HTTP/HTTPS server.	
<b>Always send HTTP Basic Authentication Information</b>	Includes configured user name and password in HTTP request before receiving authentication challenge from the server. Default is <b>No</b> .	
<b>Verify host when using HTTPS</b>	Verifies host name in server certificate when using HTTPS. Default is <b>Yes</b> .	
<b>Provisioning via</b>	Choose the method that the base station uses to request handset ipei config file. Can use TFTP, HTTP or HTTPS.	
<b>Config Server Path</b>	Sets IP address or domain name of configuration server. The server hosts a copy of the configuration file to be installed on the DP750.  Default is <b>fm.grandstream.com/gs</b> .  <b>Note:</b> Make sure to not prepend address with "http://" or any other protocol.	
<b>Config File Prefix</b>	Checks if configuration files are with matching prefix before downloading them. This field enables user to store different configuration files in one directory on the provisioning server.	
<b>Config File Postfix</b>	Checks if configuration files are with matching postfix before downloading them. This field enables user to store different configuration files in one directory on the provisioning server.	



<b>Enable Handset Config Upgrade</b>	Checks to allow handset config upgrade for handset related settings. Default is <b>No</b> .
<b>Handset Config File Prefix</b>	If configured, only the handset configuration file with the matching encrypted prefix will be downloaded and flashed into the device.
<b>Handset Config File Postfix</b>	If configured, only the handset configuration file with the matching encrypted postfix will be downloaded and flashed into the device.
<b>Allow DHCP Option 43 and Option 66 to Override Server</b>	Obtains configuration and upgrade server's information from DHCP server using options 66 and 43. <b>Note:</b> If DHCP Option 66 is enabled, the DP750 will attempt downloading the firmware file from the server URL provided by DHCP, even though <b>Config Server Path</b> is left blank.
<b>Allow DHCP Option 120 to Override SIP Server</b>	Obtains configuration and update SIP server information from DHCP server using options 120. <b>Note:</b> If DHCP option 120 is enabled, the sip server setting can be changed for profile 1.
<b>3CX Auto Provision</b>	Sends multicast "SUBSCRIBE" message for provisioning at booting stage, used for PnP (Plug-and-Play) configuration. Default is <b>Yes</b> .
<b>Automatic Provisioning</b>	Specifies when provisioning process will be initiated; there are 4 options: <ul style="list-style-type: none"> <li>• <b>No:</b> Base station will only request configuration files once at boot up.</li> <li>• <b>Check every X minutes:</b> User needs to specify a period in minutes.</li> <li>• <b>Check every day:</b> User needs to specify "Hour of the day (0-23)".</li> <li>• <b>Check every week:</b> User needs to specify "Hour of the day (0-23)" and "Day of the week (0-6)". <b>Note:</b> Day of week is starting from Sunday.</li> </ul> Default is <b>No</b> .
<b>Hour of the Day (0-23)</b>	Defines the hour of the day to check the HTTP/TFTP server for configuration file changes. Default is <b>1</b> .
<b>Day of the Week (0-6)</b>	Defines the day of the week to check HTTP/TFTP server for configuration file changes. Default is <b>1</b> .
<b>Authenticate Conf File</b>	Authenticates configuration file before being accepted. This protects the device configuration from unauthorized modifications. Default is <b>No</b> .
<b>Upload Device Config</b>	Uploads manually device configuration (XML and TXT formats are supported) to base station.



<b>Device Config (TXT)</b>	Downloads actual device configuration file in .txt format.	
<b>Device Config (XML)</b>	Downloads default device configuration file in .xml format.	
<b>Backup Configuration</b>	<p>Generates an XML config file storing all current configuration after pressing <b>Backup Settings</b> and display list of backup files available (users need to wait a few seconds and refresh the provisioning page to display the backup files).</p> <p>Maximum of 10 backup files are supported and when it reaches 10 entries, this feature will be disabled.</p> <p><b>Note:</b> Click on <b>Download</b> to download the specific backup or <b>Delete</b> to remove all the backup files.</p>	
<b>Web/SSH Access</b>		
<b>User Password</b>	Configures user level password. Case sensitive and max. length of 30 characters.	
<b>Confirm Password</b>	Configures the new user password again to confirm the new password.	
<b>Admin Password</b>	Configures admin level password. Case sensitive and max length is 30 characters.	
<b>Confirm Password</b>	Configures the new user password again to confirm the new password.	
<b>Access Control Lists</b>	<b>White list for WAN side</b>	If white list exists, then only these IP addresses are allowed to web and SSH access.
	<b>Black list for WAN side</b>	If black list exists and white list is empty, then only these IP addresses are not allowed to web and SSH access
<b>TR-069</b>		
<b>Enable TR-069</b>	Enables / Disables TR-069 service. Default is <b>No</b> .	
<b>ACS URL</b>	Specifies URL of TR-069 Auto Configuration Server. (e.g., http://acs.mycompany.com), or IP address.	
<b>ACS Username</b>	Enters username to authenticate to ACS.	
<b>ACS Password</b>	Enters password to authenticate to ACS.	
<b>Periodic Inform Enable</b>	Sends periodic inform packets to ACS. Default is <b>No</b>	
<b>Periodic Inform Interval</b>	Configures to sends periodic "Inform" packets to ACS based on specified interval.	
<b>Connection Request Username</b>	Enters username for ACS to connect to the base station.	



<b>Connection Request Password</b>	Enters password for ACS to connect to the base station.
<b>Security Settings – Web / SSH</b>	
<b>HTTP Web Port</b>	Customizes HTTP port used to access base station web UI. Default is <b>80</b> .
<b>HTTPS Web Port</b>	Customizes HTTPS port used to access base station web UI. Default is <b>443</b> .
<b>Web Access Mode</b>	Determines the protocol to be user for the web interface access. Default is <b>HTTP</b> .
<b>Disable SSH</b>	Disables SSH access. Default is <b>No</b> .
<b>SSH Port</b>	Customizes SSH access port. Default is <b>22</b> .
<b>Security Settings – SIP TLS Settings</b>	
<b>SIP TLS Certificate</b>	Specifies SSL certificate used for SIP over TLS in X.509 format. Base station has built-in private key and SSL certificate.
<b>SIP TLS Private Key Password</b>	Specifies SSL certificate key used for SIP over TLS in X.509 format. Base station has built-in private key and SSL certificate.
<b>SIP TLS Private Key Password</b>	Specifies SSL certificate key password used for SIP over TLS in X.509 format.
<b>Security Settings – RADIUS</b>	
<b>Primary RADIUS Server</b>	Defines the primary RADIUS server (Remote Authentication Dial-In User Service) to authenticate dial-in users and authorize their access to requested system or service.
<b>Primary RADIUS Authentication Port</b>	Uses specified port for authentication with the primary RADIUS server. Default is <b>1812</b> .
<b>Primary RADIUS Account Port</b>	Specifies port to be used for the primary RADIUS account. Default is <b>1813</b> .
<b>Primary RADIUS Server Secret</b>	Enters secret string to be used to authenticate the RADIUS connection to the primary server. It should match RADIUS configuration.
<b>Secondary RADIUS Server</b>	Sets IP or FQDN of the secondary RADIUS server. In case primary radius server becomes unusable, the secondary will take role and manage credit resources in the network.



<b>Secondary RADIUS Authentication Port</b>	Uses specified port for authentication with the secondary RADIUS authentication. Default is <b>1812</b> .
<b>Secondary RADIUS Account Port</b>	Specifies port to be used for the secondary RADIUS account. Default is <b>1813</b> .
<b>Secondary RADIUS Sever Secret</b>	Enters secret string to be used to authenticate the RADIUS connection to the secondary server. It should match RADIUS configuration.
<b>RADIUS Timeout</b>	Specifies period of time before request is cancelled if no response. Default is <b>2</b> .
<b>RADIUS Retry</b>	Specifies amount of retry attempts if RADIUS communication failure. Default is <b>3</b> .

### Security Settings – Device Custom Certificate

<b>Device Custom Certificate</b>	Configures the certificate used by device during provisioning and web access.
<b>Device Custom Private Key</b>	Configures the private key used by device during provisioning and web access
<b>Enable Device Custom Certificate</b>	When enables the device will use the custom certificate, otherwise it will use the default certificates. Default is <b>No</b> .

### Date and Time

<b>NTP Server</b>	Defines URL or IP address of the NTP (Network Time Protocol) server. Used by the base to synchronize the date and time. A list of public NTP servers can be found at <a href="http://pool.ntp.org">pool.ntp.org</a> .
<b>NTP Update Interval</b>	Contacts NTP server at specified period of time (in minutes) to obtain the date and time. Default is <b>60</b> minutes.
<b>Allow DHCP Option 42 to NTP Server</b>	Obtains NTP server address from a DHCP server using DHCP Option 42; it will override configured NTP Server. If set to “No”, the base will use configured NTP server to synchronize time and date even if a NTP server is provided by DHCP server. Default is <b>No</b> .
<b>Time Zone</b>	Selects time zone to define date/time on the base.
<b>Self-Defined Time Zone</b>	Allows users to define their own time zone.
<b>Allow DHCP Option 2 to override time zone</b>	Obtains time zone setting (offset) from a DHCP server using DHCP Option 2; it will override selected time zone. If set to “No”, the base station will use selected time zone even if provided by DHCP server. Default is <b>No</b> .



Syslog	
<b>Syslog Protocol</b>	Allow sending syslog through secured TLS protocol to syslog server. Default is UDP. <b>Note:</b> CA verification is required
<b>Syslog Server</b>	Sets IP address or URL of system log server. The server collects system log information from the base station. User may configure the Syslog port by adding it after the Syslog Server address. When configured, the Syslog messages will be sent to this port instead of the default syslog port. Default is <b>514</b> .
<b>Syslog Level</b>	<p>Selects log level; the level is one of DEBUG, INFO, WARNING, ERROR (default is <b>NONE</b>). Syslog messages are sent based on the following events:</p> <ol style="list-style-type: none"> <li>1. product model/version on boot up (INFO level)</li> <li>2. NAT related info (INFO level)</li> <li>3. sent or received SIP message (DEBUG level)</li> <li>4. SIP message summary (INFO level)</li> <li>5. inbound and outbound calls (INFO level)</li> <li>6. registration status change (INFO level)</li> <li>7. negotiated codec (INFO level)</li> <li>8. Ethernet link up (INFO level)</li> <li>9. SLIC chip exception (WARNING and ERROR levels)</li> <li>10. memory exception (ERROR level)</li> </ol> <p>The Syslog uses USER facility. In addition to standard Syslog payload, it contains the following components:</p> <p><i>GS_LOG: [device MAC address] [error code] error message.</i></p> <p><u>Example:</u> May 19 02:40:38 192.168.1.14 GS_LOG: [00:0b:82:00:a1:be][000] Ethernet link is up</p>
<b>Print SIP in Syslog</b>	Includes full SIP messages in syslog.
Packet Capture	
<b>Status</b>	Displays packet capture status. When user starts to capture trace file, it will show "RUNNING" status, otherwise, it will show "STOPPED".
<b>With RTP Packets</b>	Defines whether packet capture file contains RTP or not. Default setting is <b>No</b> .
Factory Reset	
<b>Force Reboot</b>	Kills active processes and forces the reboot of DP750 base station.



<b>Configure Web UI Button</b>	<b>Reset Type</b>	<p>Specifies the type of reset to perform via the Web UI reset button:</p> <p>- There are 3 reset type for Web UI button:</p> <ol style="list-style-type: none"> <li><b>1. Full Factory Reset:</b> Reset all the settings.</li> <li><b>2. NVRAM Settings Only:</b> Reset all the settings except subscription information, so the handset will stay in subscribed after reset, but all the other settings like account info, call settings, audio settings, etc., will be reset.</li> <li><b>3. DECT Settings Only:</b> Reset only the subscription (wipe out all the subscription information), but keep all the other settings like account, SIP settings.</li> </ol>
	<b>Perform Selected Reset</b>	Press Reset button to reset settings based on the reset type selected.
<b>Configure Hardware Button</b>	<b>Reset Type</b>	<p>Specifies the type of reset to perform via hardware button:</p> <p>- There are 4 reset types for hardware button:</p> <ol style="list-style-type: none"> <li><b>1. Full Factory Reset:</b> Reset all the settings.</li> <li><b>2. NVRAM Settings Only:</b> Reset all the settings except subscription information, so the handset will stay in subscribed after reset, but all the other settings like account info, call settings, audio settings, etc. will be reset.</li> <li><b>3. DECT Settings Only:</b> Reset only the subscription (wipe out all the subscription information), but keep all the other settings like account, SIP settings.</li> <li><b>4. Disabled:</b> Disable the hardware button to factory reset the base for security purpose.</li> </ol>

### Support - Support Documentation

<b>Online Support</b>	Redirects users to tools page and DP7xx product pages available on Grandstream official website.
<b>Offline Support</b>	Allows users to download the drilling templates.

### Support - Configuration Support

<b>Download Default Device Configuration</b>	Downloads the default device configuration file in .txt and .XML formats.
<b>Download UCM Zero Config Template</b>	Download the zero config templates files for UCM firmware version before and after 1.0.10.39.





Support - Debug Tools		
<b>Remote Log Submission - Terms &amp; Conditions</b>	<b>Agree to terms?</b>	By clicking the submit button, you agree to terms and conditions for submitting debug logs and allow the device to send these files to Grandstream to be used for troubleshooting purposes. <b>Note:</b> Grandstream will not collect any information without customers acknowledged and permissions.
	<b>Email Address</b>	Configures email field for core collection tools. Users can leave a contact email to get feedbacks.
	<b>Comments</b>	Includes a comment with information regarding the use of the device when the problem occurred. As an alternative to the device submitting the files, you may download the files below and submit them to Grandstream manually.
<b>Debug Log Files</b>	Kills phone control process on base station and generates core file and other debug information and also it allows users to delete the generated log files. Reboot required to restart process.	
<b>Handset Notification</b>	Notifies handset when a debug file is available after recovery. Default is <b>No</b> .	

## Phonebook Page Definitions

Table 14: Phonebook Page Definitions

Global Phonebook XML Settings	
<b>Global Phonebook Type</b>	Selects type of global phonebook to use. If set to <b>XML</b> , DP750 will use the configuration in Global Phonebook XML Settings page. If set to <b>LDAP</b> , DP750 will use configuration in Global Phonebook LDAP Settings page.
<b>Enable Automatic XML Phonebook Download</b>	Sends periodic requests to download XML Phonebook via HTTP, HTTPS, or TFTP.
<b>HTTP/HTTPS User Name</b>	Enters user name to authenticate with HTTP/HTTPS server.
<b>HTTP/HTTPS Password</b>	Enters password to authenticate with HTTP/HTTPS server.
<b>Phonebook XML Server Path</b>	Indicates server path to download XML phonebook file. This field could be IP address or URL, with up to 256 characters.



<b>Phonebook Download Interval</b>	Sets interval to send XML phonebook download requests (in minutes). If set to 0, automatic download is disabled. Valid range is 5 to 720. Default is <b>5</b> minutes.
<b>Import XML Phonebook</b>	<b>Upload:</b> Uploads manually global XML phonebook file to the base station. <b>Delete:</b> Clears global XML phonebook file in the base station.
<b>Export XML Phonebook</b>	Downloads global XML phonebook from the base station in .xml format.

### Global Phonebook LDAP Settings

<b>Global Phonebook Type</b>	Selects type of global phonebook to use. If set to XML, DP750 will use the configuration in Global Phonebook XML Settings page. If set to LDAP, DP750 will use configuration in Global Phonebook LDAP Settings page.
<b>LDAP protocol</b>	Chooses LDAP or LDAPS (LDAP over TLS) protocol. Default is <b>LDAP</b> .
<b>Server Address</b>	Configures IP address or domain name of the LDAP server.
<b>Port</b>	Determines LDAP server port. Default is <b>389</b> .
<b>Base</b>	Indicates the location in the directory where the search is requested to begin. <u>Example:</u> dc=grandstream, dc=com ou=Boston, dc=grandstream, dc=com
<b>User Name</b>	Binds "Username" for querying LDAP servers. Some LDAP servers allow anonymous binds in which case the setting can be left blank.
<b>Password</b>	Binds "Password" for querying LDAP servers. The field can be left blank if the LDAP server allows anonymous binds.
<b>LDAP Filter</b>	LDAP filter to limit which contacts are fetched from the server. LDAP statement to limit which contacts are fetched from the server. Statement must be in parenthesis.
<b>LDAP Version</b>	Selects LDAP protocol version to send bind requests. Default is <b>Version 3</b> .
<b>First Name Attribute</b>	Defines first name attributes of each record to be returned in the LDAP search result. This field allows users to configure multiple space separated name attributes. <u>Example:</u> gn cnsn description



<b>Last Name Attribute</b>	<p>Defines last name attributes of each record to be returned in the LDAP search result.</p> <p>This field allows users to configure multiple space separated name attributes.</p> <p><u>Example:</u></p> <p>gn cnsn description</p>
<b>Work Number Attribute</b>	<p>Specifies which LDAP attribute represent the contact's work number. Must be in number attributes on LDAP server.</p>
<b>Home Number Attribute</b>	<p>Specifies which LDAP attribute represent the contact's home number. Must be in number attributes on LDAP server.</p>
<b>Mobile Number Attribute</b>	<p>Specifies which LDAP attribute represent the contact's mobile number. Must be in number attributes on LDAP server.</p>
<b>Max. Hits</b>	<p>Specifies maximum number of results to be returned by LDAP server. If set to 0, server will return all search results. Valid range is 1 to 3000. Default is <b>500</b>.</p>
<b>Search Timeout</b>	<p>Sets interval (in seconds) for the server to process the request and return search results to the client. Default is <b>30</b> seconds.</p>

### Private Phonebook Settings

<b>Phonebook Name</b>	<p>Defines private phonebook name.</p>
<b>Import XML Phonebook</b>	<p><b>Upload:</b> Uploads manually private XML phonebook file to the base station.</p> <p><b>Delete:</b> Clears private XML phonebook file in the base station</p>
<b>Export XML Phonebook</b>	<p>Downloads private XML phonebook from the base station in .xml format.</p>

## Change Base Station Admin PIN code

For security reasons, advanced settings in DP750 base station cannot be accessed from DP720 handset except if Admin PIN code is provided. By default, Admin PIN code is 0000.

We strongly recommend changing your Admin PIN code following below steps:

1. Access the Web GUI of your DP750 using the admin's username and password. (Default username and password is: admin/admin).
2. Press **Login** to access your settings.
3. Go to **DECT → General Settings** tab.
4. Enter your new **Admin PIN Code** (only digits accepted) in appropriate field.



5. Press **Save and Apply** to save your settings.

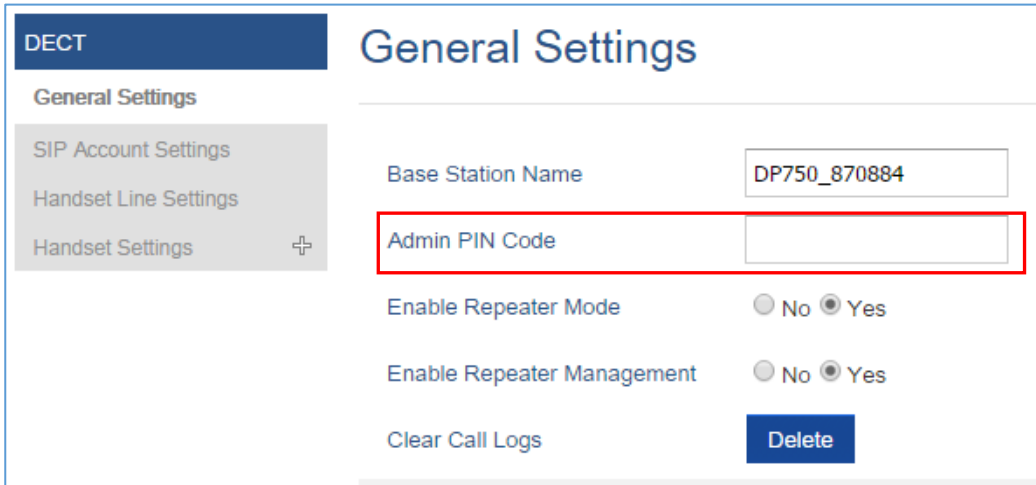

The screenshot shows the 'General Settings' page for a DECT system. On the left is a navigation menu with options: 'General Settings', 'SIP Account Settings', 'Handset Line Settings', and 'Handset Settings'. The main content area is titled 'General Settings' and contains the following fields and controls:

- Base Station Name:** A text input field containing 'DP750\_870884'.
- Admin PIN Code:** An empty text input field, highlighted with a red border.
- Enable Repeater Mode:** Radio buttons for 'No' and 'Yes', with 'Yes' selected.
- Enable Repeater Management:** Radio buttons for 'No' and 'Yes', with 'Yes' selected.
- Clear Call Logs:** A blue button labeled 'Delete'.

Figure 15: Admin PIN Code

## Register DP720 Handset to DP750 Base Station

1. On DP750 Base station, press and hold the Radio/Page button for 7 seconds until the Radio icon starts blinking to start Subscription process. Or Access web UI, and press **Subscribe** icon  to **Open Subscription**.
2. On DP720, press "Subscribe" softkey if available on the main screen or access **Menu** → **Settings** → **Registration** → **Register** while the DP750 Radio icon is blinking.

**Note:** "Subscribe" softkey appears only if DP720 is not registered to any DP750 base station.

3. Select **BaseX** (X=1-4) corresponding to the desired base station DP750, then press **Subscribe**.
4. The DP720 will search for nearby base stations and will display the RFPI code and Base station name of the discovered DP750.
5. Press **Subscribe** to pair with the displayed DP750.
6. The DP720 will display **Easy Pairing** on the LCD and play an audible buzz when successful. Then it will return to the home screen, displaying the handset name and number assigned by the registered base station.

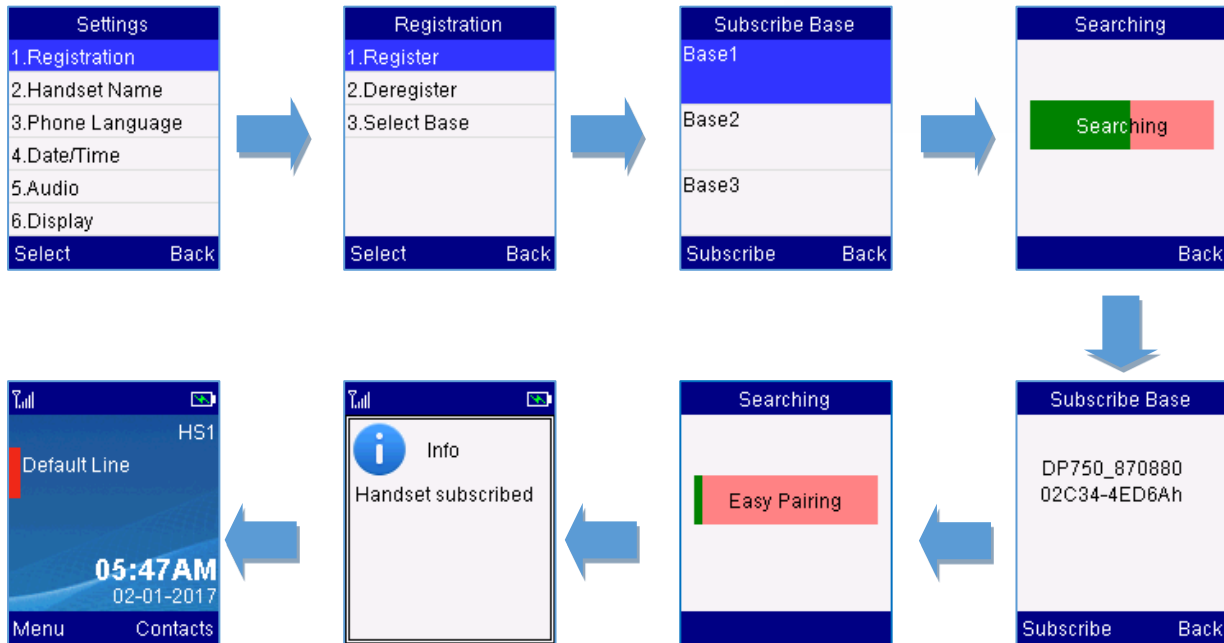





Figure 16: Registration Process

## Using DP720 with Multiple DP750 Base Stations

DP720 is able to be registered to up four different DP750 base stations.

### Registering DP720 to an additional DP750 base station

Considering DP720 is previously registered to an initial base station, please follow below steps to register a handset to an additional base station:

1. Press **Menu** (left softkey  or the selection key  ) to bring up operation menu.
2. Use arrow keys to reach **Settings**  and navigate to **Registration**.
3. Select **Register**.
4. Navigate to an unsubscribed base using arrow keys, and click on **Subscribe**.
5. Make sure that the subscription is opened on the new base station.

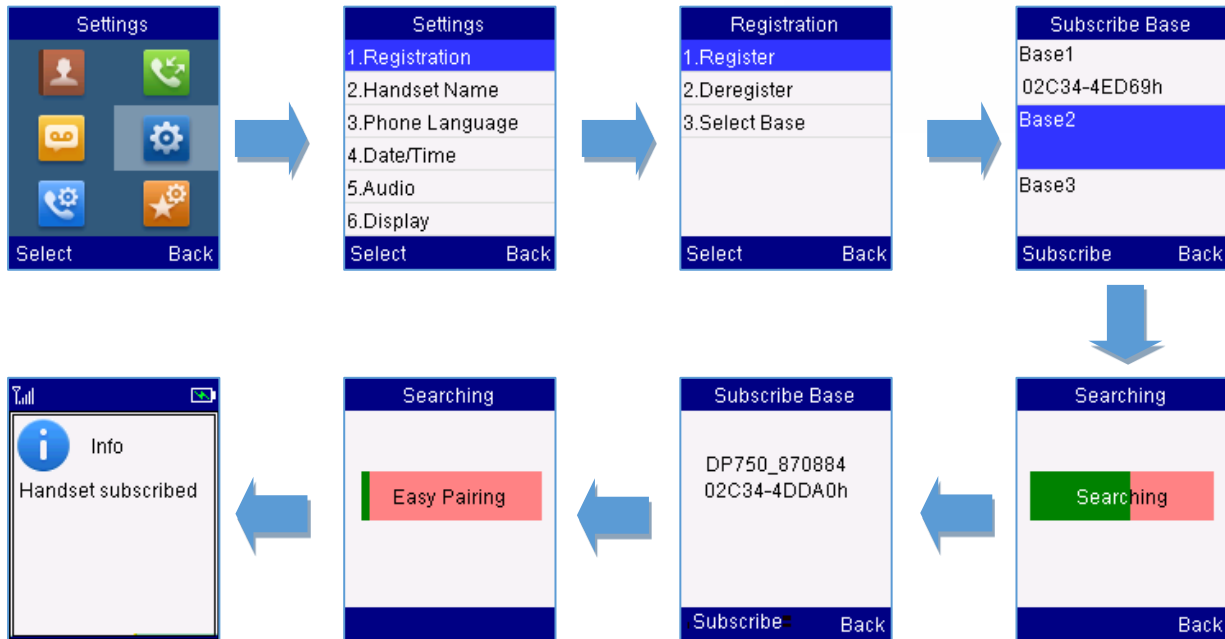





Figure 17: Multiple Base Stations Registration

### Switching Between Different Base Stations

1. Press "Menu" (left softkey  or the selection key  ) to bring up operation menu.
2. Use arrow keys to reach **Settings**  .
3. Select **Registration**.
4. Navigate to **Select Base** using arrow keys.
5. Select the desired base station and press **Select**.

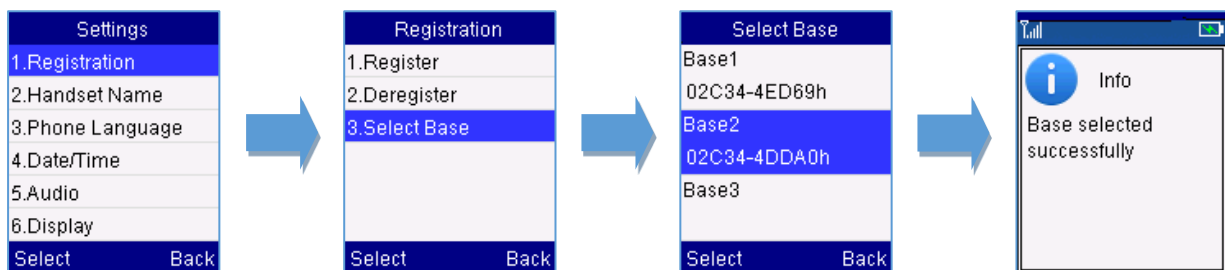







Figure 18: Switching Between Base Stations

## Unregister the DP720

- **Using DP720 Handset:**

1. On DP720, press “Menu” (left softkey  or the selection key  ) to bring up operation menu.
2. Press arrow keys to move the cursor to **Settings** and then press “Select”.
3. Navigate to **Registration**, then press “Select” (left softkey  ).
4. Navigate to **Deregister**.
5. Select the Handset to be unregistered and press “Deregister” (left softkey  ).
6. Enter the system PIN code (default: 0000).
7. Press “Done” (left softkey  ) to confirm or “Back” (right softkey  ) to cancel.

- **Using DP750 Base Station UI:**

1. Access DP750 Web Interface.
2. Go to **Status → DECT Base Status**.
3. Locate the handset to unregister and press “Unsubscribe” button.

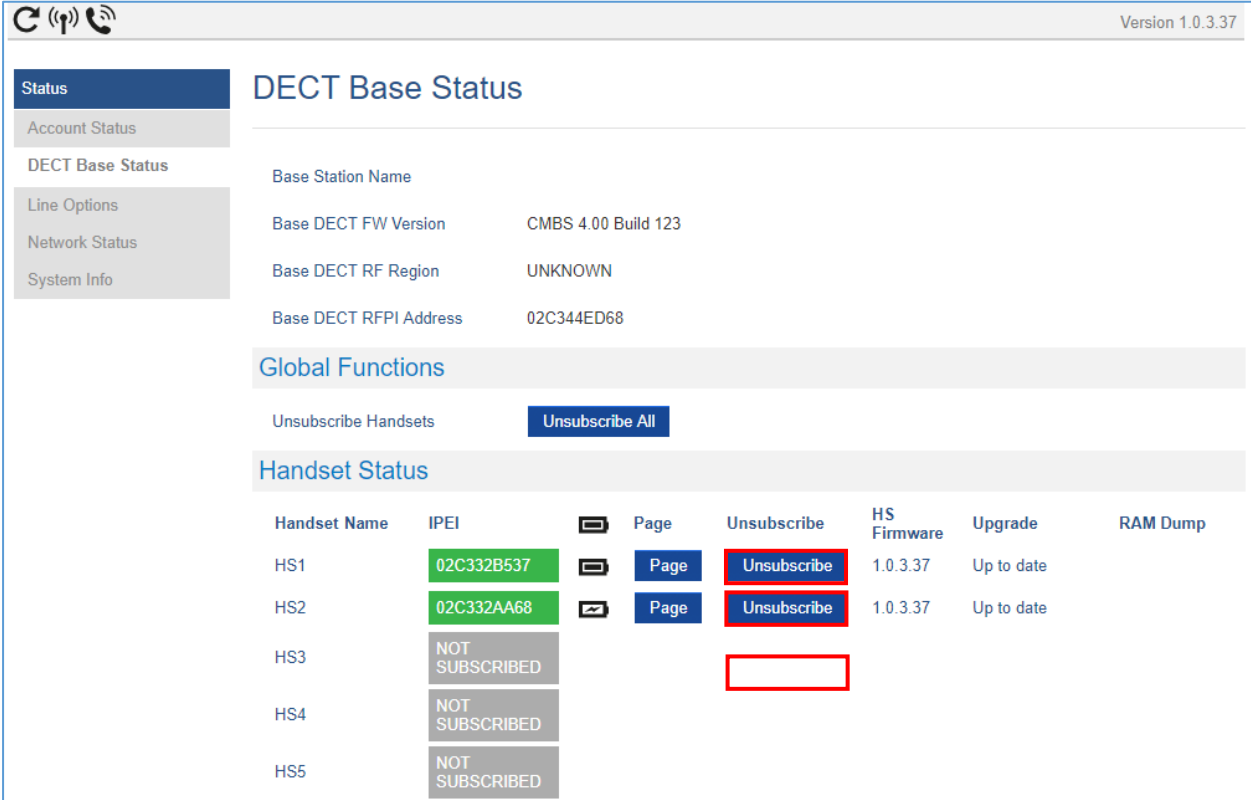





Handset Name	IPEI	Page	Unsubscribe	HS Firmware	Upgrade	RAM Dump
HS1	02C332B537	 Page		1.0.3.37	Up to date	
HS2	02C332AA68	 Page		1.0.3.37	Up to date	
HS3	NOT SUBSCRIBED					
HS4	NOT SUBSCRIBED					
HS5	NOT SUBSCRIBED					

Figure 19: Unregister DP720 from DP750 web UI

## Locating a DP720 Handset from DP750 Base station

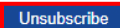
In some situations, you may have a DP720 handset incorrectly positioned and you don't know its current location. You can locate a DP720 handset from his registered DP750 base station using below steps:

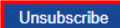
### Locate via DP750 Web UI

1. Access the Web GUI of your DP750 using the admin's username and password. (Default username and password is: admin/admin).
2. Press **Login** to access your settings and navigate to **Status → DECT Base Status** tab.
3. Choose which handset to locate and press its corresponding **Page** button.
4. A paging call will be received on the selected DP720 handset.

**Note:** If you press **Page All** icon , all registered DP720 handsets will be receiving paging call.

5. Once located, you can press any key on the handset or press **Page** or **Page All** to end paging call.

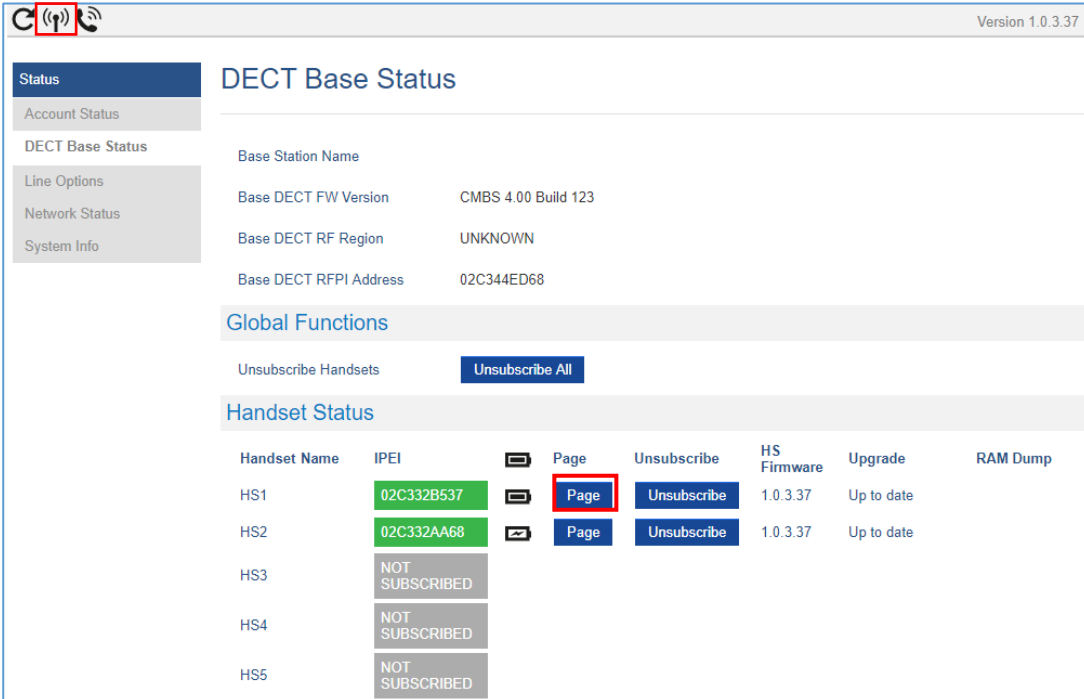

Version 1.0.3.37

**Status**

Account Status

DECT Base Status

Line Options

Network Status

System Info

### DECT Base Status

Base Station Name

Base DECT FW Version: CMBS 4.00 Build 123

Base DECT RF Region: UNKNOWN

Base DECT RFPI Address: 02C344ED68

### Global Functions

Unsubscribe Handsets [Unsubscribe All](#)

### Handset Status

Handset Name	IPEI	Page	Unsubscribe	HS Firmware	Upgrade	RAM Dump
HS1	02C332B537	<a href="#">Page</a>	<a href="#">Unsubscribe</a>	1.0.3.37	Up to date	
HS2	02C332AA68	<a href="#">Page</a>	<a href="#">Unsubscribe</a>	1.0.3.37	Up to date	
HS3	NOT SUBSCRIBED					
HS4	NOT SUBSCRIBED					
HS5	NOT SUBSCRIBED					

Figure 20: Locate Handset via Web UI

### Locate via DP750 Base station

1. On DP750 Base station back side, press **Radio/Page** button  .



2. All registered handsets will receive Paging call.
3. Once located, you can end the paging calling by pressing any key on the handsets or by pressing again **Radio/Page** button.

## Register a SIP Account

DP750 supports up to 10 SIP accounts, 5 handsets. Each Handset can be configured up to 10 accounts. Please be aware that line settings will be affected by DID settings (hunting group settings) in “DECT - SIP Account Settings”.

### Register Account via Web User Interface

1. Access the Web GUI of your DP750 using the admin's username and password. (Default username and password is: admin/admin).
2. Press **Login** to access your settings and navigate to **Profiles** tab and select a profile to use.

DP750 supports up to 4 profiles. A profile is a set of settings including general settings, network settings, SIP setting, audio setting, call settings and ring tones, etc.  
A profile can be used with different SIP accounts.

3. In **General Settings**, set the following:
  - a. **Profile Active** to **Yes**.
  - b. **SIP Server** field with your SIP server IP address or FQDN.
  - c. **Failover SIP Server** with your Failover SIP Server IP address or FQDN. Leave empty if not available.
  - d. **Prefer Primary SIP Server** to **No** or **Yes** depending on your configuration. Set to **No** if no Failover SIP Server is defined. If “**Yes**”, account will register to Primary SIP Server when failover registration expires.
  - e. **Outbound Proxy** with your Outbound Proxy IP Address or FQDN. Leave empty if not available.

For more information, related to above options please refer to [Technical Information table](#)

4. Press **Save and Apply** to save your configuration.



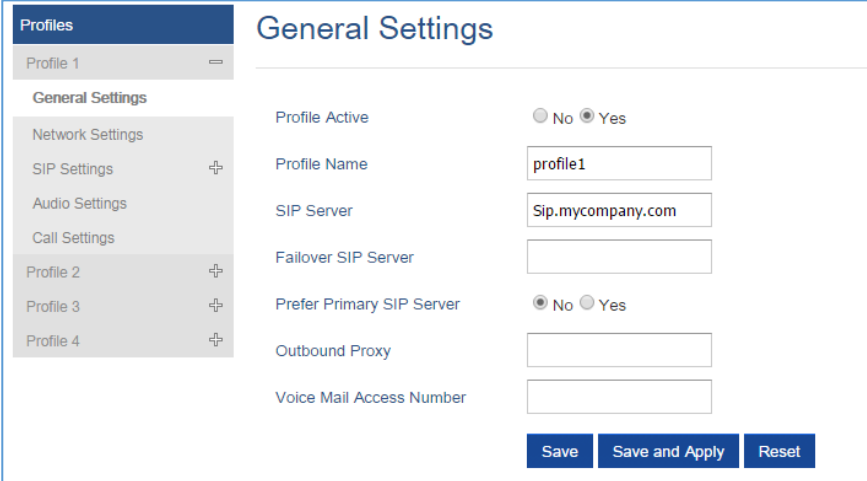

**Profiles**

Profile 1

**General Settings**

Profile Active  No  Yes

Profile Name

SIP Server

Fallover SIP Server

Prefer Primary SIP Server  No  Yes

Outbound Proxy

Voice Mail Access Number

**Save** **Save and Apply** **Reset**

**Figure 21: SIP Settings**

5. Go to **DECT → SIP Account Settings**
6. Configure your SIP details in desired account:
  - a. **Account:** Select Account row to configure (Account 1 – Account 10).
  - b. **SIP User ID:** User account information, provided by VoIP service provider (ITSP). Usually in the form of digit similar to phone number or actually a phone number.
  - c. **Authenticate ID:** SIP service subscriber's Authenticate ID used for authentication. Can be identical to or different from SIP User ID.
  - d. **Password:** SIP service subscriber's account password to register to SIP server of ITSP. For security reasons, the password will field will be shown as empty.
  - e. **Name:** Any name to identify this specific user.
  - f. **Profile:** Select the corresponding Profile ID (1/2/3/4).
  - g. **HS Mode:** Assign the account to specific handset (HS1, HS2...) or hunting group mode.
  - h. **Active:** Set to **Yes**. If set to **No**, account is disabled and will not register.
7. Press **Save and Apply** to save your configuration.

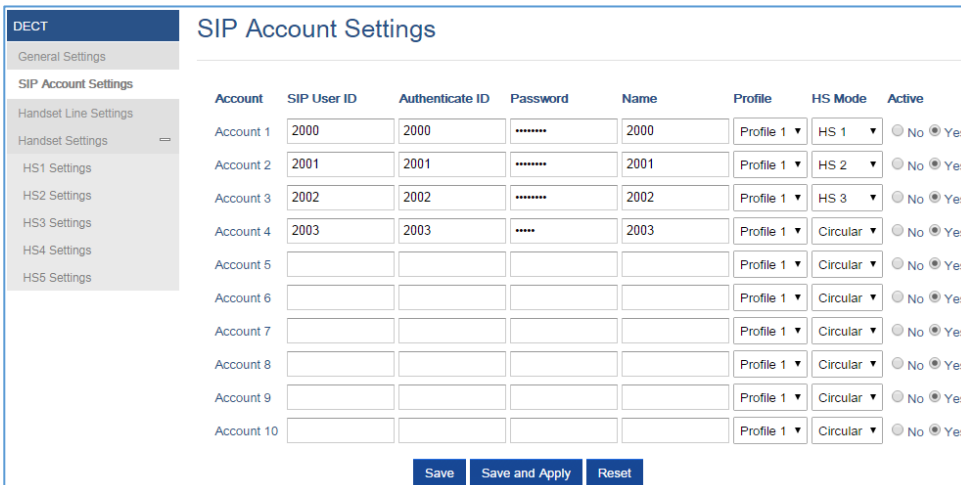

**DECT**

**SIP Account Settings**

Account	SIP User ID	Authenticate ID	Password	Name	Profile	HS Mode	Active
Account 1	<input type="text" value="2000"/>	<input type="text" value="2000"/>	<input type="text" value="*****"/>	<input type="text" value="2000"/>	Profile 1 ▼	HS 1 ▼	<input type="radio"/> No <input checked="" type="radio"/> Yes
Account 2	<input type="text" value="2001"/>	<input type="text" value="2001"/>	<input type="text" value="*****"/>	<input type="text" value="2001"/>	Profile 1 ▼	HS 2 ▼	<input type="radio"/> No <input checked="" type="radio"/> Yes
Account 3	<input type="text" value="2002"/>	<input type="text" value="2002"/>	<input type="text" value="*****"/>	<input type="text" value="2002"/>	Profile 1 ▼	HS 3 ▼	<input type="radio"/> No <input checked="" type="radio"/> Yes
Account 4	<input type="text" value="2003"/>	<input type="text" value="2003"/>	<input type="text" value="*****"/>	<input type="text" value="2003"/>	Profile 1 ▼	Circular	<input type="radio"/> No <input checked="" type="radio"/> Yes
Account 5	<input type="text"/>	<input type="text"/>	<input type="text"/>	<input type="text"/>	Profile 1 ▼	Circular	<input type="radio"/> No <input checked="" type="radio"/> Yes
Account 6	<input type="text"/>	<input type="text"/>	<input type="text"/>	<input type="text"/>	Profile 1 ▼	Circular	<input type="radio"/> No <input checked="" type="radio"/> Yes
Account 7	<input type="text"/>	<input type="text"/>	<input type="text"/>	<input type="text"/>	Profile 1 ▼	Circular	<input type="radio"/> No <input checked="" type="radio"/> Yes
Account 8	<input type="text"/>	<input type="text"/>	<input type="text"/>	<input type="text"/>	Profile 1 ▼	Circular	<input type="radio"/> No <input checked="" type="radio"/> Yes
Account 9	<input type="text"/>	<input type="text"/>	<input type="text"/>	<input type="text"/>	Profile 1 ▼	Circular	<input type="radio"/> No <input checked="" type="radio"/> Yes
Account 10	<input type="text"/>	<input type="text"/>	<input type="text"/>	<input type="text"/>	Profile 1 ▼	Circular	<input type="radio"/> No <input checked="" type="radio"/> Yes

**Save** **Save and Apply** **Reset**

**Figure 22: SIP Accounts Settings**



After applying your configuration, your phone will register to your SIP Server. You can verify if your DECT phone has registered with your SIP server from your DP750 web interface under **Status** → **Account Status** (a green background with Yes under SIP Registration column for corresponding account indicates the account(s) has been successfully registered).



Account	SIP User ID	SIP Server	SIP Registration	HS Mode	HS1	HS2	HS3	HS4	HS5
Account 1	2000	192.168.5.250	YES	HS 1					
Account 2	2001	192.168.5.250	YES	HS 2					
Account 3	2002	192.168.5.250	YES	HS 3					
Account 4	2003	192.168.5.250	YES	Circular					
Account 5			N/A						
Account 6			N/A						
Account 7			N/A						
Account 8			N/A						
Account 9			N/A						
Account 10			N/A						

Figure 23: Account Status

## Multiple Lines and Hunting Groups

The DP750 Base Station has the ability to assign 10 lines to each registered DP720 handset (Up to 5 Handsets) to receive/make calls.

When a handset has many lines configured, users can select specific line for outgoing calls using **Outgoing Default Line** feature.

For incoming calls, users can choose either to redirect them to a specific handset or to many using Hunting Group feature so to have the same phone number and incoming calls will be distributed in a Linear, Circular or Parallel manner among the handsets active in that Hunting Group. The number of hunting groups is limited by the number of SIP accounts registered to the base station (up to 10 accounts).

Hunting group feature is mainly used in office, warehouse and call center environments to distribute incoming calls in the best way depending on the type of hunt group.

In order to configure hunting groups for DP720 Handsets registered to the Base, users need first to register SIP accounts on DP750 Base Station **SIP Account Settings** and then assign accounts accordingly as lines for DP720 Handsets **Handset Line Settings**.

## Handset Line Settings

This section will describe how to assign lines for each DP720 Handset for making calls.

1. Access the Web GUI of your DP750 using the admin's username and password. (Default username and password is: admin/admin).
2. Press **Login** to access your settings.
3. Go to **DECT → Handset Line Settings**, and assign to Handsets the SIP accounts already configured. Each handset can be configured to use up to 10 sip accounts.

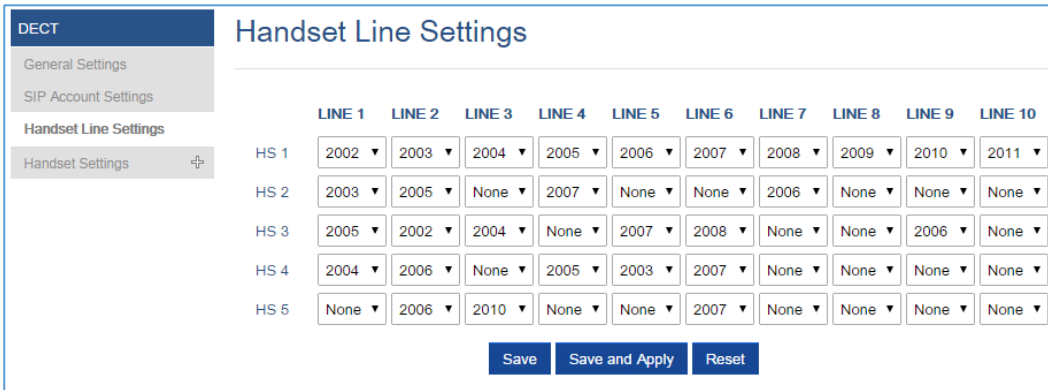

	LINE 1	LINE 2	LINE 3	LINE 4	LINE 5	LINE 6	LINE 7	LINE 8	LINE 9	LINE 10
HS 1	2002	2003	2004	2005	2006	2007	2008	2009	2010	2011
HS 2	2003	2005	None	2007	None	None	2006	None	None	None
HS 3	2005	2002	2004	None	2007	2008	None	None	2006	None
HS 4	2004	2006	None	2005	2003	2007	None	None	None	None
HS 5	None	2006	2010	None	None	2007	None	None	None	None

Figure 24: Handset Line Settings

After applying your configuration, **Account Status** page will display the status of handsets along with accounts status. Each column shows one HS; each row shows if the account is assigned to a HS.

**For example:** If the account 2, 4, 5, and 6 are assigned to the HS2, the column of HS2 will have cells 2, 4, 5 and 6 in green background, and account 1, 3, 7, 8, 9 and 10 are in gray background. If a line is being used it will be blinking in a green / white background.

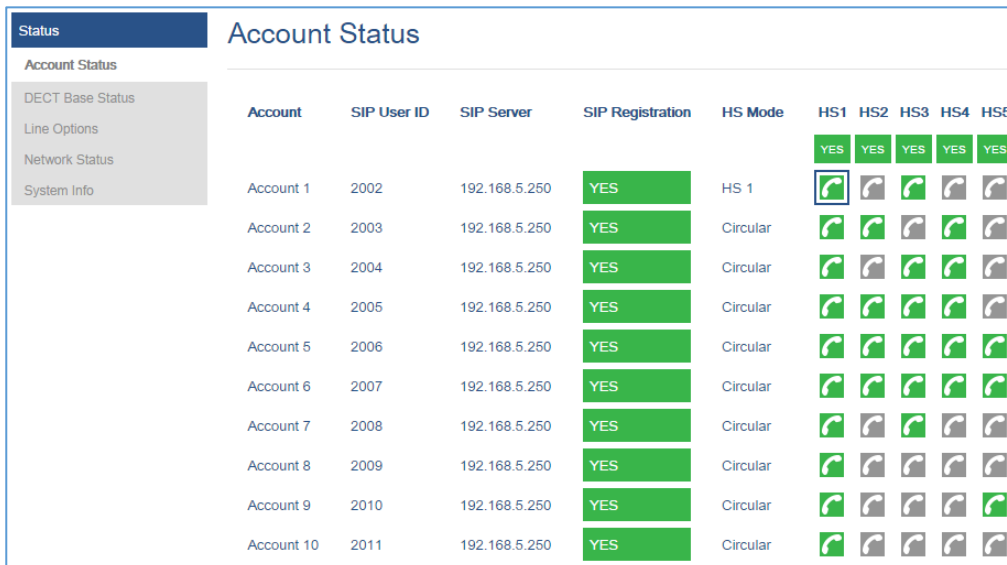

Account	SIP User ID	SIP Server	SIP Registration	HS Mode	HS1	HS2	HS3	HS4	HS5
Account 1	2002	192.168.5.250	YES	HS 1	🔄	🔄	🔄	🔄	🔄
Account 2	2003	192.168.5.250	YES	Circular	🔄	🟢	🟢	🟢	🟢
Account 3	2004	192.168.5.250	YES	Circular	🔄	🟢	🟢	🟢	🟢
Account 4	2005	192.168.5.250	YES	Circular	🔄	🟢	🟢	🟢	🟢
Account 5	2006	192.168.5.250	YES	Circular	🔄	🟢	🟢	🟢	🟢
Account 6	2007	192.168.5.250	YES	Circular	🔄	🟢	🟢	🟢	🟢
Account 7	2008	192.168.5.250	YES	Circular	🔄	🟢	🟢	🟢	🟢
Account 8	2009	192.168.5.250	YES	Circular	🔄	🟢	🟢	🟢	🟢
Account 9	2010	192.168.5.250	YES	Circular	🔄	🟢	🟢	🟢	🟢
Account 10	2011	192.168.5.250	YES	Circular	🔄	🟢	🟢	🟢	🟢

Figure 25: Account Status – Line Status



## Outgoing Default Line

When a Handset is configured with more than one line, users can change the default outgoing line on DP720 Handset using keypad **Menu** → **Call Settings** → **Outgoing Default Line**, see next screenshot



## Hunting Groups

DP750 supports 3 types of hunting groups as described below:

*In the examples below, we consider that all handsets are in same hunting group and only the type of hunting group differs.*

- **Circular:** The base station will note which handset answered the last call, and forward the call to the next available handset in round-robin fashion.

In the example below; the 1<sup>st</sup> incoming call was sent to HS1 since all handsets were available; 2<sup>nd</sup> incoming call will be sent to HS2 since previous call was answered by HS1 and HS2 is the next available handset in the list; 3<sup>rd</sup> will be sent to HS4 since HS2 was the last one answering the call and HS3 is busy making an outgoing call (if HS3 was available, the call will be sent to HS3).

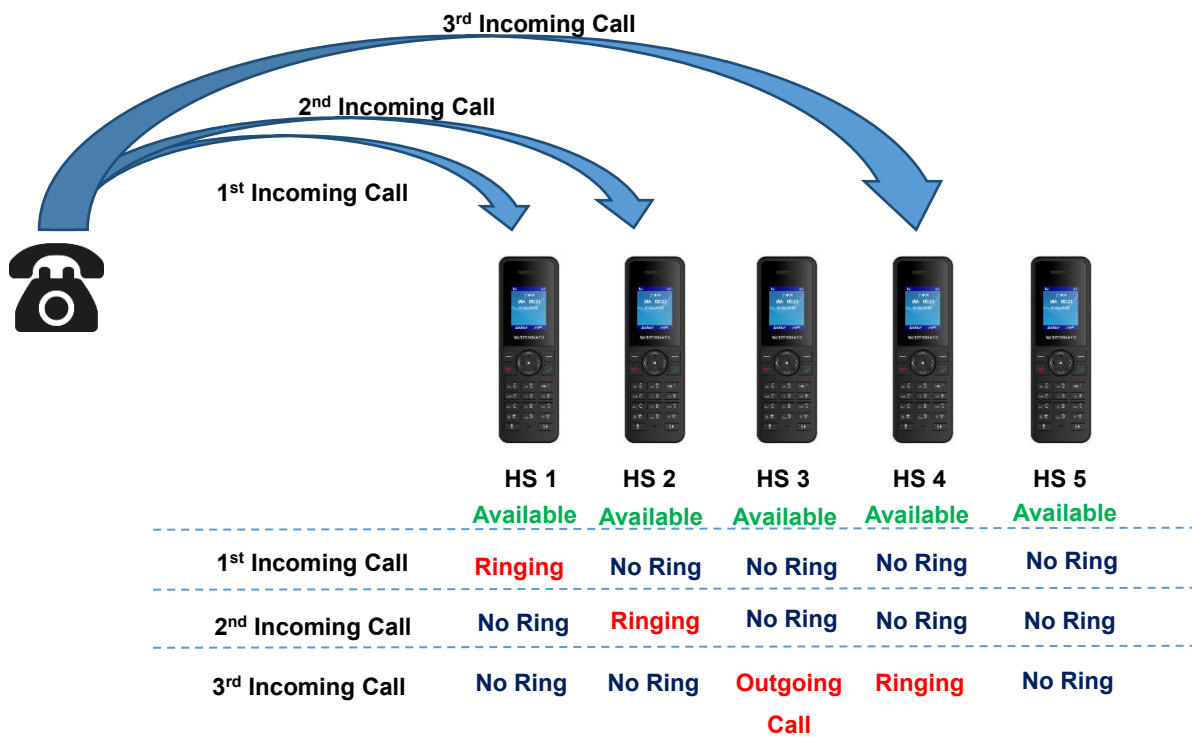

- **Linear:** The base station will distribute the call in predefined order from the lowest-numbered available handset, if no answer within ring timeout, the call will be sent to next available handset in sequence. This mode is also called “serial hunting”.

In the example below; all handsets are available, the incoming call will be sent to HS1 since it's the lowest-numbered available handset, if no answer within ring timeout, the call will be sent to HS2 since it's the next available lowest-numbered handset, and same applies for HS3 and etc.

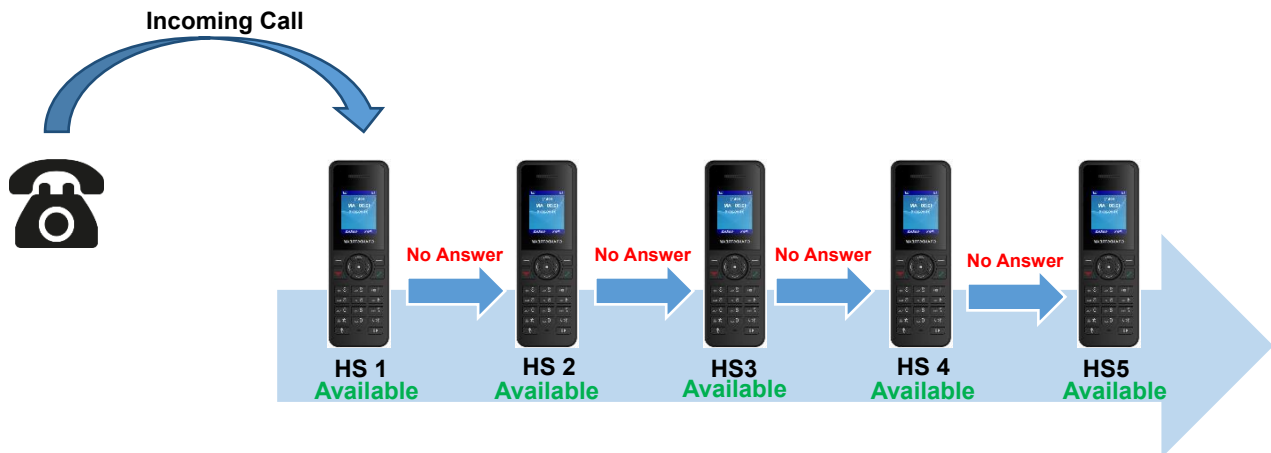

- **Parallel:** In this mode, all phones ring concurrently. If one phone answers, the remaining available phones can make new outgoing calls.

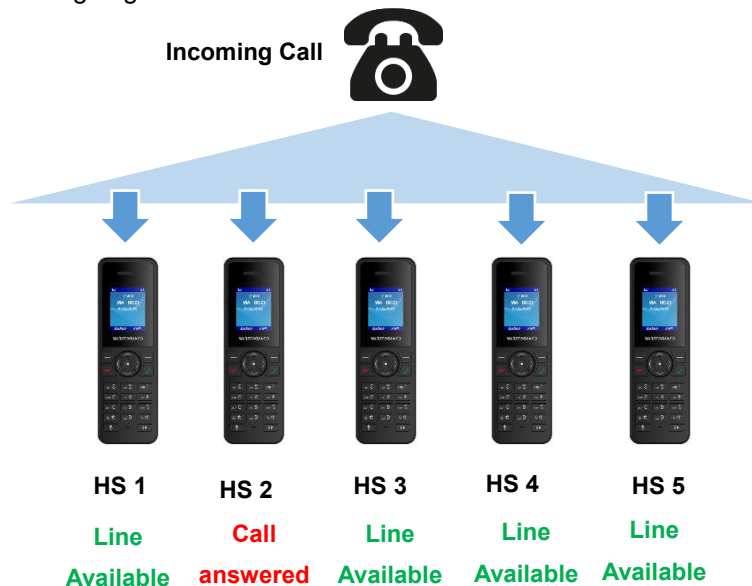

This section will describe how to configure hunting groups for incoming calls:  
 Below steps are considering that SIP accounts were previously registered.



1. Access the Web GUI of your DP750 using the admin's username and password. (Default username and password is: admin/admin).
2. Press **Login** to access your settings.
3. Go to **DECT → SIP Account Settings**.
4. Set **HS Mode** depending on your needs to configure your hunting groups.
5. Press **Save and Apply** to save your settings.

**Example:**

In the example below Account 3 (2002) is assigned to HS1, HS3, HS4 and HS5, and the hunting group (**HS Mode**) is set to **Parallel**, so incoming calls to that account will make HS1, HS3, HS4 and HS5 ring simultaneously, and when one of the Handsets answers, the remaining three will be able to make or receive new calls using that account.

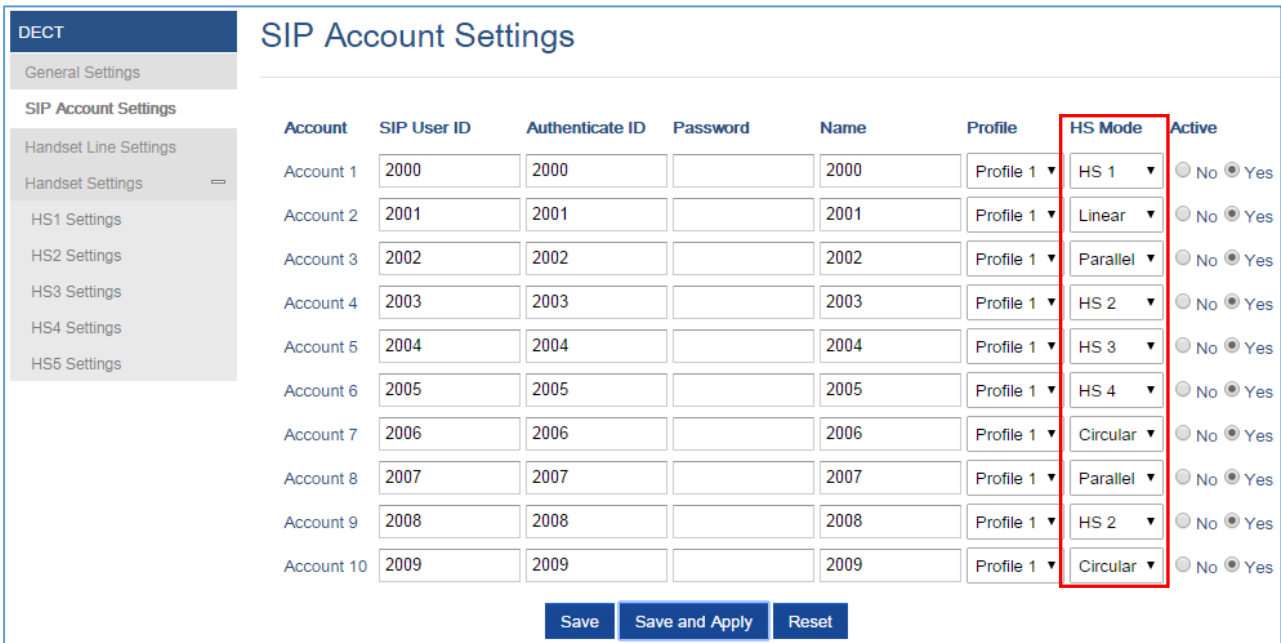

Account	SIP User ID	Authenticate ID	Password	Name	Profile	HS Mode	Active
Account 1	2000	2000		2000	Profile 1	HS 1	<input type="radio"/> No <input checked="" type="radio"/> Yes
Account 2	2001	2001		2001	Profile 1	Linear	<input type="radio"/> No <input checked="" type="radio"/> Yes
Account 3	2002	2002		2002	Profile 1	Parallel	<input type="radio"/> No <input checked="" type="radio"/> Yes
Account 4	2003	2003		2003	Profile 1	HS 2	<input type="radio"/> No <input checked="" type="radio"/> Yes
Account 5	2004	2004		2004	Profile 1	HS 3	<input type="radio"/> No <input checked="" type="radio"/> Yes
Account 6	2005	2005		2005	Profile 1	HS 4	<input type="radio"/> No <input checked="" type="radio"/> Yes
Account 7	2006	2006		2006	Profile 1	Circular	<input type="radio"/> No <input checked="" type="radio"/> Yes
Account 8	2007	2007		2007	Profile 1	Parallel	<input type="radio"/> No <input checked="" type="radio"/> Yes
Account 9	2008	2008		2008	Profile 1	HS 2	<input type="radio"/> No <input checked="" type="radio"/> Yes
Account 10	2009	2009		2009	Profile 1	Circular	<input type="radio"/> No <input checked="" type="radio"/> Yes

**Figure 26: Hunting Group configuration**

Status		Account Status									
Account Status		Account	SIP User ID	SIP Server	SIP Registration	HS Mode	HS1	HS2	HS3	HS4	HS5
DECT Base Status		Account 1	2000	192.168.5.250	YES	HS 1	YES	YES	YES	YES	YES
DECT Repeater Status		Account 2	2001	192.168.5.250	YES	Linear	YES	YES	YES	YES	YES
Line Options		Account 3	2002	192.168.5.250	YES	Parallel	YES	YES	YES	YES	YES
Network Status		Account 4	2003	192.168.5.250	YES	HS 2	YES	YES	YES	YES	YES
System Info		Account 5	2004	192.168.5.250	YES	HS 3	YES	YES	YES	YES	YES
		Account 6	2005	192.168.5.250	YES	HS 4	YES	YES	YES	YES	YES
		Account 7	2006	192.168.5.250	YES	Circular	YES	YES	YES	YES	YES
		Account 8	2007	192.168.5.250	YES	Parallel	YES	YES	YES	YES	YES
		Account 9	2008	192.168.5.250	YES	HS 2	YES	YES	YES	YES	YES
		Account 10	2009	192.168.5.250	YES	Circular	YES	YES	YES	YES	YES

**Figure 27: Hunting Group Status**

## Configuration via Keypad

To configure the LCD menu using DP720's keypad, follow the instructions below:

- Register the DP720 to DP750. Please see [Register DP720 Handset to DP750 Base Station](#);
- **Enter/Confirm/ selection:** Press the left softkey, right softkey, on-hook key or OK/Select key to enter the selected option, back to last layer or exit;
- **Exit:** Press “right softkey” to exit to the previous menu;
- **Return to Home page:** Press “On-hook” key to exit to the main menu.
- The DP720 automatically exits to main mode with an incoming call, when the phone is off hook or left idle for more than 20 seconds.
- When the phone is in idle, pressing the DOWN navigation key can enter the **Outgoing call log**.

Please refer to [DP720 Handset Menu Structure](#) for more details.



## Call Features

The DP750/DP720 supports traditional and advanced telephony features including call forward and etc.

**Table 15: Call Features**

<b>*72</b>	<p><b>Unconditional Call Forward.</b> To set up unconditional call forward:</p> <ul style="list-style-type: none"> <li>• Off hook the phone;</li> <li>• Dial *72 and then enter the number to forward the call;</li> <li>• Press OK softkey or SEND key.</li> </ul>
<b>*73</b>	<p><b>Cancel Unconditional Call Forward.</b> To cancel the unconditional call forward:</p> <ul style="list-style-type: none"> <li>• Off hook the phone;</li> <li>• Dial *73;</li> <li>• Hang up the call.</li> </ul>
<b>*90</b>	<p><b>Busy Call Forward.</b> To set up busy call forward:</p> <ul style="list-style-type: none"> <li>• Off hook the phone;</li> <li>• Dial *90 and then enter the number to forward the call;</li> <li>• Press OK softkey or SEND key.</li> </ul>
<b>*91</b>	<p><b>Cancel Busy Call Forward.</b> To cancel the busy call forward:</p> <ul style="list-style-type: none"> <li>• Off hook the phone;</li> <li>• Dial *91;</li> <li>• Hang up the call.</li> </ul>
<b>*92</b>	<p><b>Delayed Call Forward.</b> To set up delayed call forward:</p> <ul style="list-style-type: none"> <li>• Off hook the phone;</li> <li>• Dial *92 and then enter the number to forward the call;</li> <li>• Press OK softkey or SEND key.</li> </ul>
<b>*93</b>	<p><b>Cancel Delayed Call Forward.</b> To cancel the delayed call forward:</p> <ul style="list-style-type: none"> <li>• Off hook the phone;</li> <li>• Dial *93;</li> <li>• Hang up the call.</li> </ul>



## DP750 Phonebook Management

DP750/720 support Private and Shared Phonebooks; both phonebook types can be used at same time:

### Private Phonebook

Private phonebook allows you to manage your contacts on each registered handset; each handset can have his own private phonebook with his own contacts. DP750 supports up to 5 private phonebooks.

A private phonebook can be assigned to one or more handsets registered to the base.

The following steps explain how upload your private phonebook and assign it to a specific handset:

1. Access the Web GUI of your DP750 using the admin's username and password. (Default username and password is: admin/admin).
2. Press **Login** to access your settings and go to **Phonebook → Private Phonebook Settings**.

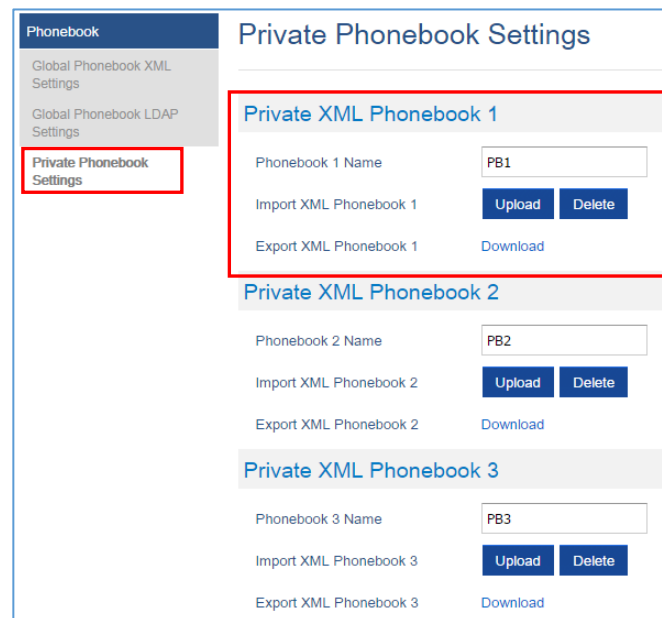
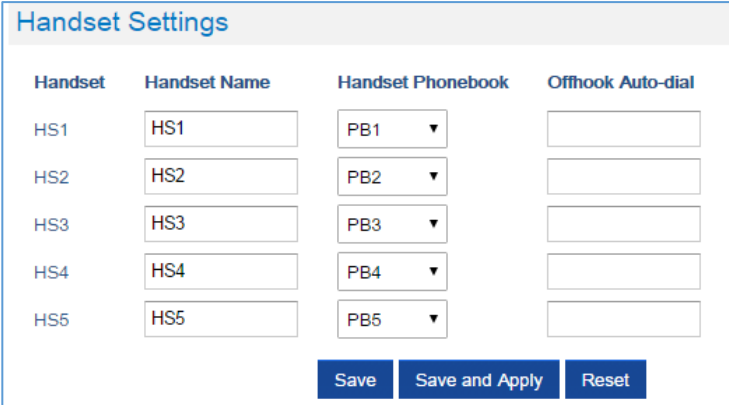

**Figure 28: Private Phonebook Settings**

3. In **Private XML Phonebook X** section (X from 1 to 5):
  - a. Enter **Phonebook X Name** (default value is PB1 for first handset, PB2 for second handset, etc.).
  - b. Press **Upload** button to **Import XML Phonebook X**.
  - c. Browse your computer files and select your desired **phonebook.xml** file.
  - d. Press **Save and Apply** to save your settings.
4. Go to **DECT → General Settings** tab.



- In **Handset Settings** section, select your **Handset Phonebook** to assign it to a specific handset as shown below where **PB1** is assigned to **HS1**, **PB2** is assigned to **HS2**...



Handset	Handset Name	Handset Phonebook	Offhook Auto-dial
HS1	HS1	PB1	
HS2	HS2	PB2	
HS3	HS3	PB3	
HS4	HS4	PB4	
HS5	HS5	PB5	

Save Save and Apply Reset

**Figure 29: Handset Phonebook Settings**

You can assign same Private Phonebook to more than one handset. For example, we can assign **Handset Phonebook** named **PB1** to **HS1** and **HS2**. Any change in **PB1** contacts will be applied to both **HS1** and **HS2** private phonebooks.

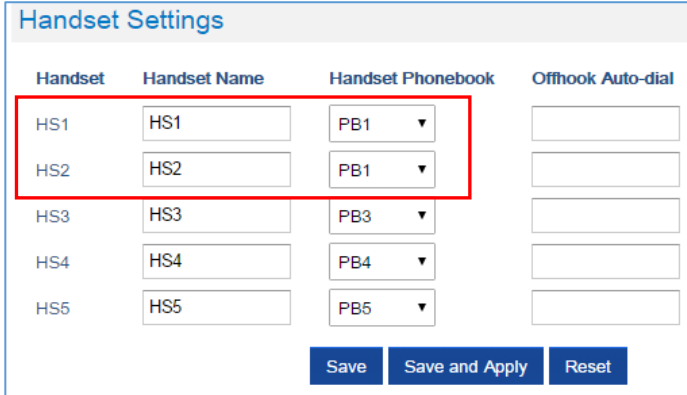

Handset	Handset Name	Handset Phonebook	Offhook Auto-dial
HS1	HS1	PB1	
HS2	HS2	PB1	
HS3	HS3	PB3	
HS4	HS4	PB4	
HS5	HS5	PB5	

Save Save and Apply Reset

**Figure 30: Handset Phonebook Selection**

- Press **Save and Apply** to save your configuration.

After applying your configuration, your DP720 handset will display uploaded phonebook contacts. You can access your private phonebook by pressing **Contacts** on your DP720 handset and select **Private**. Your private phonebook contacts will be loaded and displayed on your DP720 screen.

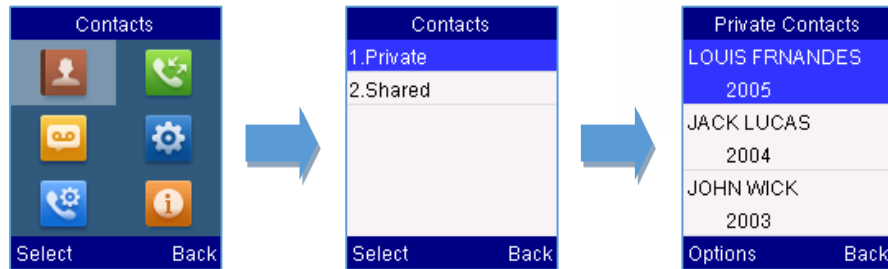

## Global Phonebook

Global phonebook allows to manage contacts and use them in all registered handsets. The contacts can be imported either via XML or via LDAP. Follow steps below to upload your shared phonebook:

### Global Phonebook via XML

1. Access the Web GUI of your DP750 using the admin's username and password. (Default username and password is: admin/admin).
2. Press **Login** to access your settings.
3. Go to **Phonebook** → **Global Phonebook XML Settings** tab.
4. Set **Global Phonebook Type** to **XML** (in this case, LDAP phonebook will not be available).

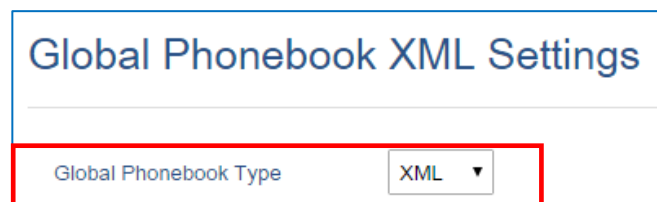

Figure 31: Global Phonebook XML Settings

5. There are two methods to import/download your XML Phonebook:
  - a. **Automatic XML Phonebook Download**

For this method, you need to use a TFTP or HTTP or HTTPS server and make your *phonebook.xml* file is available in your preferred server.

    - i. Set **Enable Automatic XML Phonebook Download** to **Enabled**, use **TFTP/HTTP or HTTPS** depending on your server.
    - ii. If using HTTP or HTTPS server and User Name and Password are required to connect to the server, set **HTTP/HTTPS User Name** and **HTTP/HTTPS Password** fields with appropriate values.
    - iii. Configure **Phonebook XML Server Path** field. This field could be IP address or URL, with up to 256 characters. The phone will request file named **phonebook.xml** from provided directory. Example: *192.168.5.1/Directory*

- iv. Configure the **Phonebook Download Interval** (in minutes) to periodically contact your server to download new phonebook file version if available. If set to 0, automatic download will be disabled. Valid range is 5 to 720.
- v. Set **Remove Manually-edited Entries on Download** to **No** to keep any contact information entered from the handset directly while downloading your global phonebook file. If set to **Yes**, contacts manually entered from handset will be removed after downloading global phonebook.

### Automatic XML Phonebook Download

Enable Automatic XML Phonebook Download	<input type="text" value="Enabled, use HTTP"/>
HTTP/HTTPS User Name	<input type="text"/>
HTTP/HTTPS Password	<input type="password"/>
Phonebook XML Server Path	<input type="text" value="192.168.5.1/Directory"/>
Phonebook Download Interval	<input type="text" value="60"/>
Remove Manually-edited Entries on Download	<input type="radio"/> No <input checked="" type="radio"/> Yes

Figure 32: Automatic XML Phonebook Download

b. **Manual XML Phonebook Management**

- i. Press **Upload** in **Import XML Phonebook**.
- ii. Browse your files and select your **phonebook.xml** file.

### Manual XML Phonebook Management

Import XML Phonebook	<input type="button" value="Upload"/> <input type="button" value="Delete"/>
Export XML Phonebook	<input type="button" value="Download"/>
<input type="button" value="Save"/> <input type="button" value="Save and Apply"/> <input type="button" value="Reset"/>	

Figure 33: Manual XML Phonebook Management

## XML Phonebook file format

```

<?xml version="1.0" encoding="UTF-8"?>
<AddressBook>
  <Contact>
    <FirstName>First name</FirstName>
    <LastName>Last name</LastName>
    <Ringtone>Ringtone ID (default 0)</Ringtone>
    <Phone type="Home">
      <phonenumber>Home phone number</phonenumber>
    </Phone>
    <Phone type="Work">
      <phonenumber>Work phone number</phonenumber>
    </Phone>
    <Phone type="Mobile">
      <phonenumber>Mobile phone number</phonenumber>
    </Phone>
  </Contact>
</AddressBook>
  
```

Object	Position	Type	Values	Comments
<b>AddressBook</b>	Root element	Mandatory	-	Root element of the XML document
<b>Contact</b>	Child element	Mandatory	-	Each contact is an entry
<b>LastName</b>	Child element	At least one of them present	String	Last name of the contact
<b>FirstName</b>	Child element		String	First name of the contact
<b>Phone</b>	Child element	Mandatory	-	Phone number
<b>PhoneNumber</b>	Child element	At least one present	Int	Type="Home" or Type="Work" or Type="Mobile"



### XML Phonebook Example:

```
<?xml version="1.0" encoding="UTF-8"?>
<AddressBook>
  <Contact>
    <FirstName>John</FirstName>
    <LastName>Doe</LastName>
    <Ringtone>0</Ringtone>
    <Phone type="Home">
      <phonenumber>1000</phonenumber>
    </Phone>
    <Phone type="Work">
      <phonenumber>1001</phonenumber>
    </Phone>
    <Phone type="Mobile">
      <phonenumber>1002</phonenumber>
    </Phone>
  </Contact>
  <Contact>
    <FirstName>Alice</FirstName>
    <LastName>Beck</LastName>
    <Ringtone>0</Ringtone>
    <Phone type="Home">
      <phonenumber>2000</phonenumber>
    </Phone>
    <Phone type="Work">
      <phonenumber>2001</phonenumber>
    </Phone>
    <Phone type="Mobile">
      <phonenumber>2002</phonenumber>
    </Phone>
  </Contact>
</AddressBook>
```



## Global Phonebook via LDAP

1. Access the Web GUI of your DP750 using the admin's username and password. (Default username and password is: admin/admin).
2. Press **Login** to access your settings.
3. Go to **Phonebook → Global Phonebook LDAP Settings** tab.
4. Set **Global Phonebook Type** to **LDAP** (in this case, XML phonebook will not be available).

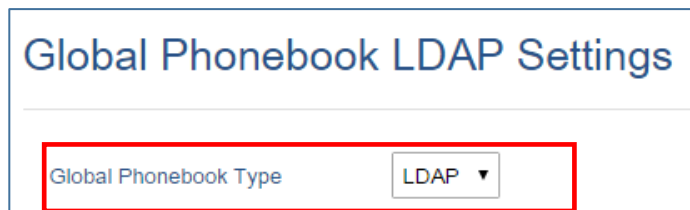

Figure 34: Global Phonebook LDAP Settings

5. Under **LDAP Phonebook Settings**, set your LDAP parameters to connect to your LDAP server. Refer to [Table 11: Phonebook Page Definitions](#) for parameters explanation.
6. Press **Save and Apply** to save your configuration.

- **Example of configuration:**

```

LDAP protocol: LDAP
Server Address: 192.168.1.100
Port: 389
Base: dc=pbx,dc=com
User Name:
Password:
LDAP Number Filter: (AccountNumber=%)
LDAP Name Filter: (CallerIDName=%)
LDAP Version: Version 3
LDAP Name Attributes: CallerIDName Email Department FirstName LastName
LDAP Number Attributes: AccountNumber MobileNumber HomeNumber Fax
LDAP Display Name: AccountNumber CallerIDName
Max. Hits: 50
Search Timeout: 30
Sort Results: Yes
LDAP Lookup: Incoming Calls / Outgoing Calls (checked)
Lookup Display Name: FirstName LastName
  
```





After applying your configuration, your global phonebook will be synchronized with all registered handsets and contacts will be displayed on your DP720 handsets screens.

You can access your Global phonebook by pressing **Contacts** on your DP720 handsets and select **Shared**. Your Global Phonebook contacts will be loaded and displayed on your DP720 screen.

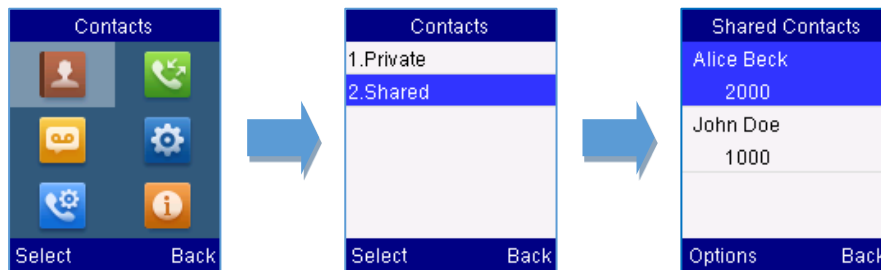

**Figure 35: Shared Contacts**

## DP750 ASSOCIATION WITH DP760 DECT REPEATER

### Important Notes:

- DP760 can relay up to 2 concurrent calls.
- After pressing Page/Reset button for more than 2 seconds on the DP760, it will enter AUTO region mode, in this mode, the three LEDs of right side keep quick blinking, then the DP760 will search the base signal in the current environment to auto associate with it and then auto switch to the same region (EU, US or BR) of the base station.
- If you have a DP760 that has FW before 1.0.3.34, you will need upgrade it to 1.0.3.34 first, then do a factory reset. After that, the unit will support Auto-Region feature and it will enter Auto Region mode.

### Enabling Repeater Mode on DP750

Before associating the DP760 DECT Repeater to your DP750 Base Station, you should firstly enable the repeater mode on your base station. Please refer following steps to enable the repeater mode on the DP750 base station:

1. Access the Web GUI of your DP750 using the admin's username and password. (Default username and password are: *admin/admin*).
2. Navigate to **DECT** → **General Settings** and set **Enable Repeater Mode** to **Yes**.

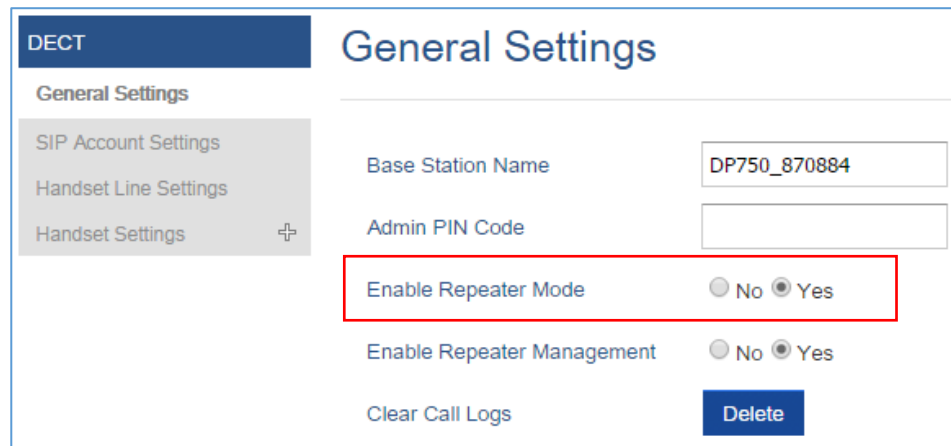

Figure 36: Enable Repeater Mode

3. Press **Save and Apply**, then **Reboot** the base to apply the new settings.

### DP760 DECT Repeater Association

After enabling the repeater mode on DP750 Base Station, you can easily associate it with your DP760 DECT Repeater using one of the following methods:



- **Auto Association**
- **Manual Association**
- **Use DP750 Repeater Management to associate DP760**

## Auto Association

To auto associate your DP760 DECT Repeater with DP750 Base Station:

1. Power on the DP760 DECT Repeater.
2. After the DP760 finish booting, the association LED  will be blinking to indicate that the repeater is searching for nearby base stations.

**Note:** If all the LEDs remain on, it indicates that the DP760 Repeater has successfully associated with a DP750 Base and ready for use. You may need to dissociate it before continuing (Please refer to [DP760 DECT REPEATER DISSOCIATION]).

3. Open subscription on your DP750 Base Station using one of following methods:
  - Rebooting the Base station.
  - Long press on page/subscribe button on the back panel of DP750 for 7 seconds.
  - Access DP750 Web GUI and press subscribe button .
4. The DP760 DECT Repeater will automatically pair to DP750. Upon successful association with the DP750 Base station all LEDs will turn ON and the repeater status will be updated as following.



The screenshot shows the 'DECT Repeater Status' web interface. On the left, there is a navigation menu with 'Status' selected, and sub-items for 'DECT Repeater Status', 'Network Status', and 'System Info'. The main content area displays the following information:

DECT Repeater Status	
Repeater Name	DP760_9e274c
Repeater FW Version	FW 03.00 Build 1294
Repeater DECT RF Region	EU
<b>Repeater Status</b>	
Status	Repeater is in normal operation
Signal Strength	Link is excellent
Number of Active Calls	0
<b>Global Functions</b>	
Base Station RFPI Address	02C344DDA0 (RPN 2)
Base Station IP Address	192.168.5.141
Disconnect from Base Station	<input type="button" value="Disconnect"/>

Figure 37: Repeater Status – Associated (Auto Association)

**Notes:**

- For auto association, the option **Use manually configured RFPI** under DP760 Web GUI should be disabled (by default disabled).
- The RF auto association requires the repeater to be close to the base during the pairing process to work properly (this is a standard DECT repeater pairing limitation).

**Manual Association**

To manually associate your DP760 DECT Repeater to your DP750 Base Station:

1. Access the Web GUI of your DP760 using the admin's username and password. (Default username and password are *admin/admin*).
2. Navigate to **DECT → General Settings** and set **Use Manually Configured RFPI** to **Yes**.
3. On **Manually Configured Base RFPI** field, configure your DP750 Base Station RFPI address.

**Note:** The RFPI Address of your DP750 Base Station is available under the Web GUI → **Status → DECT Status → Base DECT RFPI Address**.

4. Click **Save and Apply** to confirm the new settings.
5. Open subscription on your DP750 Base Station using one of following methods:
  - Rebooting the Base station
  - Long press on page/subscribe button on the back panel of DP750 for 7 seconds
  - Access DP750 Web GUI and press subscribe button .
6. The DP760 DECT Repeater will automatically pair to DP750. If the association is correctly associated, all the LEDs will remain solid on and the repeater status will be updated as following.



Status

## DECT Repeater Status

DECT Repeater Status

Network Status

Repeater Name	DP760_9e274c
Repeater FW Version	FW 03.00 Build 1294
Repeater DECT RF Region	EU

### Repeater Status

Status	Repeater is in normal operation
Signal Strength	Link is excellent
Number of Active Calls	0

### Global Functions

Base Station RFPI Address	02C344DDA0 (RPN 2)
Base Station IP Address	192.168.5.141
Disconnect from Base Station	<a href="#" style="background-color: #004a87; color: white; padding: 2px 10px; border-radius: 3px;">Disconnect</a>

**Figure 38: Repeater Status – Associated (Manual Association)**

**Note:** Make sure that **Repeater Mode** is enabled on your DP750 Base Station.

## Use DP750 Repeater Management to Associate DP760

### ❖ Enabling Repeater Management Mode

The following steps illustrate how to enable and use the Repeater Management mode on DP750:

1. Access the Web GUI of your DP750 using the admin's username and password. (Default username and password are *admin/admin*).
2. Navigate to **DECT** → **General Settings** and set **Enable Repeater Management** to **Yes**.
3. Press **Save and Apply**, then reboot the unit to apply the new settings.

DECT

## General Settings

**General Settings**

SIP Account Settings

Handset Line Settings

**Handset Settings**

HS1 Settings

HS2 Settings

HS3 Settings

HS4 Settings

HS5 Settings

Base Station Name

Admin PIN Code

Enable Repeater Mode
 No  Yes

Enable Repeater Management
 No  Yes

Clear Call Logs
Delete

### Handset Settings

Handset	Handset Name	Handset Phonebook	Offhook Auto-dial
HS1	<input type="text" value="HS1"/>	PB1 ▼	<input type="text"/>
HS2	<input type="text" value="HS2"/>	PB2 ▼	<input type="text"/>
HS3	<input type="text" value="HS3"/>	PB3 ▼	<input type="text"/>
HS4	<input type="text" value="HS4"/>	PB4 ▼	<input type="text"/>
HS5	<input type="text" value="HS5"/>	PB5 ▼	<input type="text"/>

Save
Save and Apply
Reset

**Figure 39: Repeater Associated Status**

❖ **Associating DP760 using Repeater Management Mode on DP750**

The repeater management mode displays discovered and paired devices using their name, IP and Mac addresses and also gives the possibility of associating the DP750 Base Station with DP760 DECT Repeater.

Please refer to following steps in order to associate DP760 with DP750 using repeater management mode:

1. Access the Web GUI of your DP750 using the admin's username and password. (Default username and password are *admin/admin*).
2. Navigate to **Status** → **DECT Repeater Status** and select the repeater station from **Discovered Devices**.
3. Click **Link** button to associate the base and repeater stations.

**Note:** The DP760 Repeater stations associated with DP750 Base Station are displayed and available under **Status** → **DECT Repeater Status** → **Paired Devices** with their status, signal strength, number of active calls and possibility to disconnect them from the paired base station.

**Status**

Account Status

DECT Base Status

**DECT Repeater Status**

Line Options

Network Status

System Info

## DECT Repeater Status

---

### Paired Devices

---

### Discovered Devices

Model	Name	IP	MAC	Link
DP760	DP760_8b556b	192.168.5.125	000b828b556b	<a href="#">Link</a>

**Figure 40: DECT Repeater Status on DP750**

## DP760 DECT REPEATER DISSOCIATION FROM DP750

To disconnect DP760 DECT Repeater from the Base Station DP750, please refer to following options:

### Using DP760 Web GUI

To disconnect your DP760 DECT Repeater via Web GUI, please refer to following steps:

1. Access the Web GUI of your DP760 using the admin's username and password. (Default username and password are: *admin/admin*).
2. Enter the administrator's username and password to access the Web Configuration Menu. (Default username and password are *admin/admin*)
3. Navigate to **Status** → **DECT Status** → **Global Functions** and press **Disconnect**.
4. The DP760 DECT Repeater will be automatically disconnected from the DP750 and it will start again scanning for available RFPs.

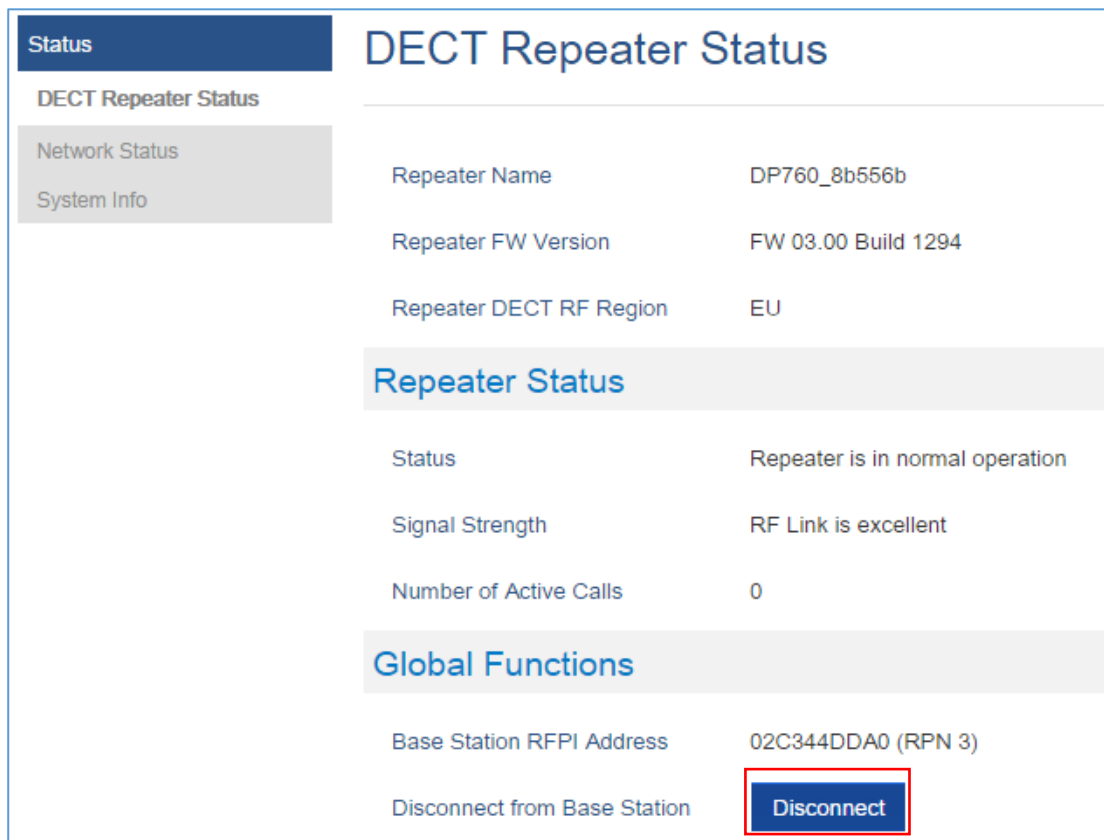

DECT Repeater Status	
Repeater Name	DP760_8b556b
Repeater FW Version	FW 03.00 Build 1294
Repeater DECT RF Region	EU
Repeater Status	
Status	Repeater is in normal operation
Signal Strength	RF Link is excellent
Number of Active Calls	0
Global Functions	
Base Station RFPI Address	02C344DDA0 (RPN 3)
Disconnect from Base Station	<b>Disconnect</b>

Figure 41: DECT Repeater Status on DP750



## Using Page Button

Long press on page button on the back panel of DP760 for 7 seconds, it will remove the association values of the previous base station.

## Using Repeater Management Mode on DP750

To disconnect your DP760 DECT Repeater using the repeater management mode on DP750:

1. Access the Web GUI of your DP750 using the admin's username and password. (Default username and password are *admin/admin*).
2. Navigate to **Status** → **DECT Repeater Status**.
3. Select the repeater station from **Discovered Devices**.
4. Click **Unlink** button to dissociate the repeater from the base station.

Status		DECT Repeater Status						
Account Status								
DECT Base Status								
<b>DECT Repeater Status</b>								
Line Options								
Network Status								
System Info								
		Paired Devices						
Model	Name	IP	MAC	Status	Signal Strength	Active Calls	Unlink	
DP760	DP760_8b556b	192.168.5.125	000b828b556b	online	RF Link is excellent	0	<a href="#">Unlink</a>	

Figure 42: DECT Repeater Status on DP750

## UPGRADING AND PROVISIONING

The DP750 can be upgraded via TFTP/HTTP/HTTPS by configuring the URL/IP Address for the TFTP/HTTP/HTTPS server and selecting a download method. Configure a valid URL for TFTP or HTTP/HTTPS; the server name can be FQDN or IP address.

### Examples of valid URLs:

firmware.grandstream.com

fw.ipvideotalk.com/gs

### DP750 Firmware Upgrade Procedure

Please follow below steps in order to upgrade the firmware version of your DP750 base station:

1. Access DP750 Web GUI (default username and password are: admin/admin).
2. Press **Login** to access your settings.
3. Go to **Maintenance** → **Firmware Upgrade** page, enter the IP address or the FQDN for the upgrade server in "**Firmware Server Path**" field and choose to upgrade via TFTP or HTTP/HTTPS.
4. Make sure to configure Firmware **Upgrade and Provisioning** to **Always Check for New Firmware**.
5. Update the change by clicking the "**Save and Apply**" button. Then "**Reboot**" or power cycle the base station to update the new firmware.



Maintenance

**Firmware Upgrade**  
 Provisioning  
 Web/SSH Access  
 TR-069  
 Security Settings  
 Date and Time  
 Syslog  
 Packet Capture  
 Factory Reset  
 Support

## Firmware Upgrade

### Base Firmware

Firmware Upgrade	<input checked="" type="radio"/> Always Check for New Firmware <input type="radio"/> Check New Firmware Only When F/W pre/suffix Changes <input type="radio"/> Always Skip the Firmware Check
HTTP/HTTPS User Name	<input type="text"/>
HTTP/HTTPS Password	<input type="password"/>
Always send HTTP Basic Authentication Information	<input checked="" type="radio"/> No <input type="radio"/> Yes
Verify host when using HTTPS	<input type="radio"/> No <input checked="" type="radio"/> Yes
Upgrade via	<input type="radio"/> TFTP <input checked="" type="radio"/> HTTP <input type="radio"/> HTTPS
Firmware Server Path	<input type="text"/>
Firmware File Prefix	<input type="text"/>
Firmware File Postfix	<input type="text"/>
Allow DHCP Option 43 and Option 66 to Override Server	<input type="radio"/> No <input checked="" type="radio"/> Yes
Automatic Upgrade	<input checked="" type="radio"/> No <input type="radio"/> Yes, check for upgrade every <input type="text" value="10080"/> minute(s) <input type="radio"/> Yes, check for upgrade every day <input type="radio"/> Yes, check for upgrade every week
Hour of the Day(0-23)	<input type="text" value="1"/>
Day of the Week (0-6)	<input type="text" value="1"/>
Firmware Key	<input type="text"/>

### Handset Firmware

Handset firmware	<input type="button" value="Upload"/> <input type="button" value="Delete"/>
Automatic Upgrade	<input checked="" type="radio"/> No <input type="radio"/> Yes

**Figure 43: Firmware Upgrade Page**

## Upgrading via Local TFTP/HTTP Servers

For users that would like to use remote upgrading without a local TFTP/HTTP server, Grandstream offers a NAT-friendly HTTP server. This enables users to download the latest software upgrades for their devices via this server. Please refer to the webpage: <http://www.grandstream.com/support/firmware>

Alternatively, users can download a free TFTP or HTTP server and conduct a local firmware upgrade. A free windows version TFTP server is available for download from:

[http://www.solarwinds.com/products/freetools/free\\_tftp\\_server.aspx](http://www.solarwinds.com/products/freetools/free_tftp_server.aspx)

<http://tftpd32.jounin.net/>.



### Instructions for local firmware upgrade via TFTP:



1. Unzip the firmware files and put all of them in the root directory of the TFTP server.
2. Connect the PC running the TFTP server and the phone to the same LAN segment.
3. Launch the TFTP server and go to the File menu→Configure→Security to change the TFTP server's default setting from "**Receive Only**" to "**Transmit Only**" for the firmware upgrade.
4. Start the TFTP server and configure the TFTP server in the phone's web configuration interface.
5. Configure the Firmware Server Path to the IP address of the PC.
6. Save and Apply the changes and reboot the base station.

End users can also choose to download a free HTTP server from <http://httpd.apache.org/> or use Microsoft IIS web server.

## Upgrading DP720 handset

User could upgrade their handsets either using the LCD menu or via the Web GUI

### Using the LCD menu

1. On DP720, press "Menu" (left softkey  or the selection key ) to bring up operation menu.
2. Press arrow keys to move the cursor to **Settings** and then press "Select".
3. Navigate to **Firmware Upgrade** and press "Select" (left softkey), the handset will upgrade the firmware available on the base station.

### Using the Web GUI

1. Access DP750 Web GUI (default username and password are: admin/admin).
2. Press **Login** to access your settings.
3. Go to **Maintenance** → **Firmware Upgrade** page, and enable the **Automatic Upgrade** option so the handset will upgrade the firmware automatically once it detects the new firmware.

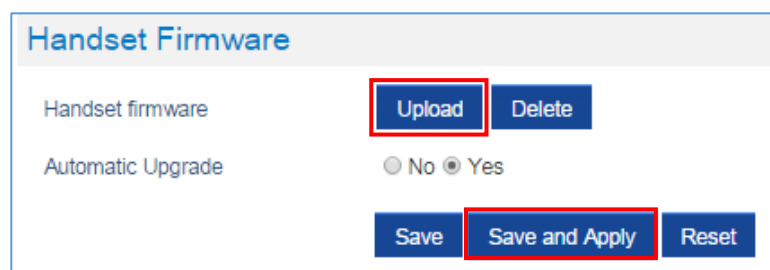

Figure 44: Handset Firmware Upgrade

4. Update the change by clicking the "**Save and Apply**" button.

**Notes:**

- The DP720 handset detects automatically if the base station is upgraded with a new firmware and display on the LCD a prompt message inviting the user to initiate the upgrade, more over under the Web GUI of the base station DP750 → Status → DECT Status → Handset Status, appears an **Upgrade All** button once the base detect that several registered handsets are using an old firmware version so the user could upgrade all handsets by pressing **Upgrade All** button.
- After downloading firmware, DP720 screen will be black and red LED will be blinking showing that firmware upgrade process is ongoing.

## DP750/DP720 Provisioning

### Configuration File Download

Grandstream SIP Devices can be configured via the Web Interface as well as via a Configuration File (binary or XML) through TFTP or HTTP/HTTPS. The **Config Server Path** is the TFTP or HTTP/HTTPS server path for the configuration file. It needs to be set to a valid URL, either in FQDN or IP address format. The **Config Server Path** can be the same or different from the **Firmware Server Path**.

A configuration parameter is associated with each particular field in the web configuration page. A parameter consists of a Capital letter P and 2 to 3 (Could be extended to 4 in the future) digit numeric numbers. i.e., P2 is associated with the "New Password" in the Web GUI → Maintenance → Web/SSH Access page → Admin Password. For a detailed parameter list, please refer to the corresponding firmware release configuration template.

When the DP750 boots up or reboots, it will send a request to download a file named "cfgxxxxxxxxxxx" followed by a configuration XML file named "cfgxxxxxxxxxxx.xml", where "xxxxxxxxxxx" is the MAC address of the phone, i.e., "cfg000b820102ab" and "cfg000b820102ab.xml". If the download of "cfgxxxxxxxxxxx.xml" file is not successful, the DP750 will send a request to download a file named "cfgdp750.xml" to allow provisioning by a model specified xml file. If the download is still unsuccessful then the provision program will download a generic cfg.xml file. The configuration file name should be in lower case letters.

For more details on XML provisioning, please refer to:

[http://www.grandstream.com/sites/default/files/Resources/gs\\_provisioning\\_guide.pdf](http://www.grandstream.com/sites/default/files/Resources/gs_provisioning_guide.pdf)



## Handset Provisioning

To configure the handset provisioning, please browse the base station Web GUI at Maintenance → Provisioning. This is the same page used for base station provisioning. Handset shares the settings of base station provisioning in the field in the red rectangle, and has its own settings in the blue rectangle. After enabled Handset Config Upgrade, need reboot the DP750 to take effect.

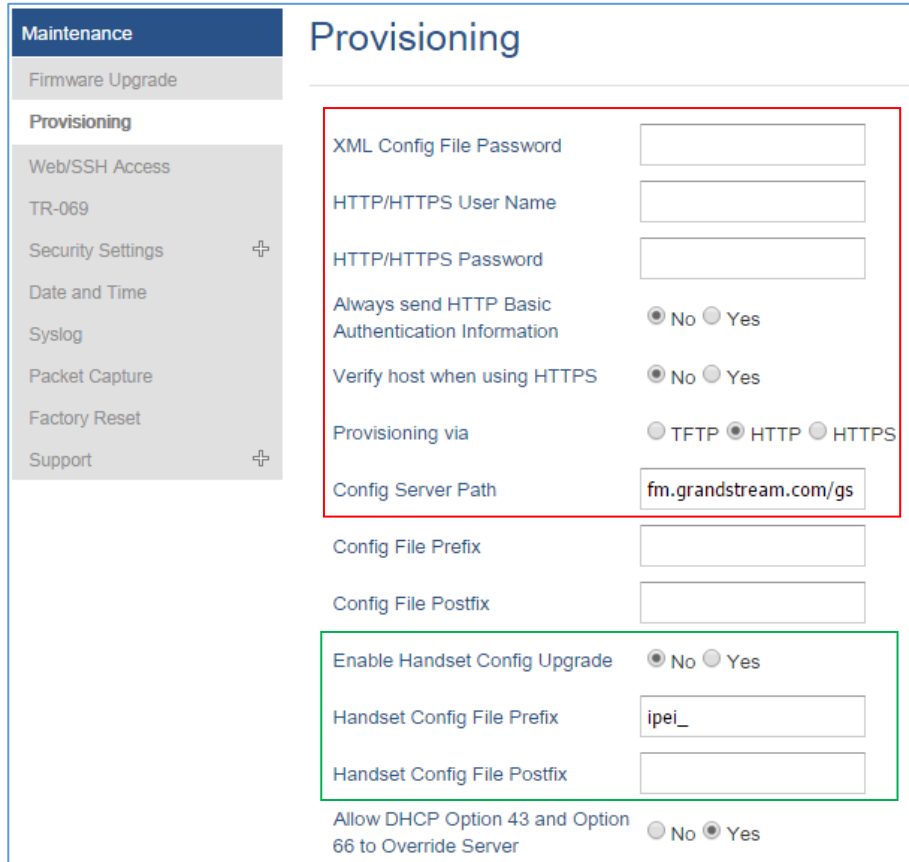

**Figure 45: Provisioning Feature**

- **Provisioning via:** Choose the method that the base station uses to request handset ipei config file. Can use TFTP, HTTP or HTTPS.
- **Config Server Path:** Defines the server path for provisioning. Do not prepend address with "http://" or any other protocol.
- **Handset Config File Prefix:** If configured, only the handset configuration file with the matching encrypted prefix will be downloaded and flashed into the device.
- **Handset Config File Postfix:** If configured, only the handset configuration file with the matching encrypted postfix will be downloaded and flashed into the device



When a DP720 registers to a DP750 for the first time or an already registered handset boots up, the DP750 will send a provisioning request for a file on the configured provisioning server, with location “Config\_Server\_Path/[Prefix][HS IPEI].xml[Postfix]”. For example, if handset’s IPEI number is 02c332b510, prefix is “ipei\_”, postfix is null, and config server path is “fw.grandstream.com/gs”, the request URL is “fw.grandstream.com/gs/ipei\_02c332b510.xml”.

For more detailed information, please refer to [Handset Provisioning Guide](#).



## RESTORE FACTORY DEFAULT SETTINGS

---

### **Warning:**

Restoring the Factory Default Settings will delete all configuration information on the phone. Please backup or print all the settings before you restore to the factory default settings. Grandstream is not responsible for restoring lost parameters and cannot connect your device to your VoIP service provider.

---

### Resetting the DP750 Base Station

There are two methods to reset your base station to the default setting:

#### Via Reset Button

1. Locate the reset hole on the back panel of your DP750.
2. Insert a pin in this hole, and press for about 7 seconds.
3. Take out the pin. The unit will restart automatically with parameters restored to default values.



**Note:** A quick press on the reset hole will just reboot the unit.

#### Via Web GUI

1. Access DP750 Web GUI (default username and password are: admin/admin).
2. Navigate to **Maintenance** → **Factory Reset**.
3. Select the **Reset Type** from the reset drop down list.
4. Press **Reset** button and the unit will prompt a confirmation message, press **OK** to reset, then the unit restart automatically with parameters restored to default values or press **Cancel** to annul the reset.

### Resetting the DP720 Handset

Please follow the instructions below to reset the DP720 Handset:

1. Press "Menu" (left softkey  or the selection key ) to bring up operation menu.
2. Press arrow keys to move the cursor to **Settings** and then press "Select".





3. Navigate to **System Settings** → **Factory Reset**, a warning window will pop out to make sure a reset is requested and confirmed;
4. Press **“Yes”** (left softkey) to confirm and the phone will reboot.

To cancel the Reset, press **“No”** (right softkey) instead.

Users also can perform factory reset using combo keys on DP720 during booting up prior it's fully booted, to give DP720 the ability to recover from some extreme cases like self-reboot or stuck right after booted up.

Please refer to following procedure for DP720 factory reset using combo key:

1. Connect the USB cable and power off DP720.
2. Power on DP720 and wait for Green LED.
3. Press 3 times Central Key (OK/Selection Key) quickly after Green LED on.
4. Press Speaker Key (left bottom) first and then Mute Key (right bottom) after Red LED on.
5. DP720 LED will start blinking in 3 colors: Green, Red and Orange if factory reset successful triggered.
6. Wait for about 1-3 minutes, the DP720 will boot up with setup wizard for initial language and date format settings.



## EXPERIENCING DP750/720

Please visit our website: <http://www.grandstream.com> to receive the most up- to-date updates on firmware releases, additional features, FAQs, documentation and news on new products.

We encourage you to browse our [product related documentation](#), [FAQs](#) and [User and Developer Forum](#) for answers to your general questions. If you have purchased our products through a Grandstream Certified Partner or Reseller, please contact them directly for immediate support.

Our technical support staff is trained and ready to answer all of your questions. Contact a technical support member or [submit a trouble ticket online](#) to receive in-depth support.

Thank you again for purchasing Grandstream DECT IP phone, it will be sure to bring convenience to both your business and personal life.

