

Grandstream Networks, Inc.

GSC3620

FHD Infrared Weatherproof, Varifocal and Auto-Focus

Dome IP Camera

User Manual



COPYRIGHT

©2021 Grandstream Networks, Inc. <https://www.grandstream.com>

All rights reserved. Information in this document is subject to change without notice. Reproduction or transmittal of the entire or any part, in any form or by any means, electronic or print, for any purpose without the express written permission of Grandstream Networks, Inc. is not permitted.

The latest electronic version of this guide is available for download here:

<https://www.grandstream.com/support>

Grandstream is a registered trademark and Grandstream logo is trademark of Grandstream Networks, Inc. in the United States, Europe, and other countries.

CAUTION

Changes or modifications to this product not expressly approved by Grandstream, or operation of this product in any way other than as detailed by this guide, could void your manufacturer warranty.

WARNING

Please do not use a different power adaptor with devices as it may cause damage to the products and void the manufacturer warranty.



FCC Caution

U.S. FCC part 15 Regulatory Information

This device complies with part 15 of the FCC Rules. Operation is subject to the following two conditions:

- (1) This device may not cause harmful interference, and
- (2) this device must accept any interference received, including interference that may cause undesired operation.

Note: This equipment has been tested and found to comply with the limits for a Class B digital device, pursuant to part 15 of the FCC Rules. These limits are designed to provide reasonable protection against harmful interference in a residential installation. This equipment generates uses and can radiate radio frequency energy and, if not installed and used in accordance with the instructions, may cause harmful interference to radio communications. However, there is no guarantee that interference will not occur in a particular installation. If this equipment does cause harmful interference to radio or television reception, which can be determined by turning the equipment off and on, the user is encouraged to try to correct the interference by one or more of the following measures:

- Reorient or relocate the receiving antenna.
- Increase the separation between the equipment and receiver.
- Connect the equipment into an outlet on a circuit different from that to which the receiver is connected.
- Consult the dealer or an experienced radio/TV technician for help.

Canada Regulatory Information

CAN ICES-3 (B)/NMB-3(B)



GNU GPL INFORMATION

GSC3620 firmware contains third-party software licensed under the GNU General Public License (GPL). Grandstream uses software under the specific terms of the GPL. Please see the GNU General Public License (GPL) for the exact terms and conditions of the license.



Table of Contents

DOCUMENT PURPOSE	9
CHANGE LOG	10
Firmware Version 1.0.5.3	10
WELCOME	11
PRODUCT OVERVIEW	12
Feature Highlights	12
GSC3620 Technical Specifications	12
GETTING STARTED	14
Equipment Packaging	14
Powering and Connecting the GSC3620	15
<i>Option A (Recommended)</i>	15
<i>Option B</i>	15
HARDWARE INSTALLATION	16
Mounting GSC3620	16
GSC3620 APPLICATION SCENARIOS	17
LAN without Internet	17
LAN with Internet	18
Application Peripheral Connection	19
GSC3620 WEB GUI	20
UPnP	20
GS Search	20
Web GUI Settings	22
GSC3620 SETTINGS	24
Live View Page	24
<i>Vari-focal and Auto-Focus Settings</i>	24
System Settings	25



<i>Date & Time Settings</i>	25
<i>Network Settings</i>	26
<i>Access Settings</i>	28
<i>User Management</i>	31
Account	33
<i>Account 1 - 4</i>	33
Phone Settings	37
<i>Phone Settings</i>	37
<i>Account [1-4] White List</i>	39
Video & Audio Settings	39
<i>Video Settings</i>	40
<i>OSD Settings</i>	41
<i>CMOS Settings</i>	42
<i>Audio Settings</i>	43
<i>Privacy Masks</i>	43
Alarm Settings	44
<i>Alarm Events Config</i>	44
<i>Alarm Config</i>	46
<i>Alarm Schedule Settings</i>	46
<i>Alarm Action Settings</i>	47
<i>Alarm Phone List</i>	49
Email & FTP Settings	49
<i>Email Settings</i>	49
<i>FTP & Center Storage</i>	51
Maintenance Settings	51
<i>Upgrade</i>	51
<i>Reboot & Reset</i>	54
<i>Debug Log</i>	54
<i>Data Maintenance</i>	55
<i>Event Notification</i>	55
<i>Certificates</i>	56
Status	57
<i>Account Status</i>	57
<i>System Info</i>	58
<i>Network Info</i>	59
EXPERIENCING THE GSC3620	60



Table of Tables

Table 1: GSC3620 Features in a Glance	12
Table 2: GSC3620 Technical Specifications	12
Table 3: Equipment Packaging – GSC3620.....	14
Table 4: GSC3620 WEB GUI Sections.....	22
Table 5: Date & Time	26
Table 6: Basic Settings	27
Table 7: Access Settings.....	28
Table 8: User Management.....	32
Table 9: SIP Account Basic & Advanced Settings	34
Table 10: Phone Settings.....	37
Table 11: White List.....	39
Table 12: Video Settings	40
Table 13: OSD Settings	42
Table 14: CMOS Settings.....	42
Table 15: Audio Settings	43
Table 16: Alarm Events Config Settings.....	44
Table 17: Motion Detection	46
Table 18: Alarm Actions	48
Table 19: Alarm Phone List	49
Table 20: Email Settings - SMTP.....	50
Table 21: Picture Storage Settings	51
Table 22: Upgrade	53
Table 23: Reset & Reboot.....	54
Table 24 : Log Manager Settings.....	56
Table 25: System Info	59
Table 26: Network Info	59

Table of Figures

Figure 1: GSC3620 Package Content	14
Figure 2: RJ45 plug installation.....	15
Figure 3: Mounting GSC3620	16
Figure 4: GSC3620 Working in LAN.....	17
Figure 5: GSC3620 working with Internet.....	18
Figure 6: Application Peripheral Connection for GSC3620.....	19



Figure 7: GS_Search tool	21
Figure 8: GSC3620 Login Page	21
Figure 9: GSC3620 Web GUI	22
Figure 10: Live View	24
Figure 11: GSC3620 Zoom	24
Figure 12: GSC3620 Auto-Focus Settings.....	25
Figure 13: Date & Time Page.....	26
Figure 14: Basic Settings Page.....	27
Figure 15: Access Settings Page	28
Figure 16: MJPEG Authentication Mode.....	30
Figure 17: RTSP steam display using VLC.....	31
Figure 18: User Management Page	32
Figure 19: Password Recovery Email	32
Figure 20: SIP Account Settings Page.....	33
Figure 21: Phone Settings Page	37
Figure 22: White List Page.....	39
Figure 23: Video Settings Page.....	40
Figure 24: OSD Settings Page	41
Figure 25: CMOS Settings Page.....	42
Figure 26: Audio Settings Page.....	43
Figure 27: Privacy Masks Configuration Page.....	43
Figure 28: Alarm Events Config page.....	44
Figure 29: Region Config	45
Figure 30: Alarm Schedule.....	46
Figure 31: Edit Schedule.....	47
Figure 32: Alarm Action.....	48
Figure 33: Edit Alarm Action.....	48
Figure 34: Alarm Phone List.....	49
Figure 35: Email Settings - SMTP Page	50
Figure 36: Picture Storage Settings.....	51
Figure 37: Upgrade Page.....	52
Figure 38: Reset & Reboot Page	54
Figure 39: Debug Log Page.....	54
Figure 40: Data Maintenance Page.....	55
Figure 41: Log Manager Page	55
Figure 42: Upload Certificate files	56
Figure 43: Trusted CA Certificates	57
Figure 44: Custom certificate	57
Figure 45: Account Status Page.....	58
Figure 46: System Info Page.....	58
Figure 47: Network Info Page	59



DOCUMENT PURPOSE

This document describes how to configure the GSC3620 via web UI menu to fully manipulate device's features. Please visit <https://www.grandstream.com/support> to download the latest "GSC3620 User Manual".

This guide covers following topics:

- [Product Overview](#)
- [Getting Started](#)
- [Hardware Installation](#)
- [GSC3620 Web GUI](#)
- [GSC3620 Settings](#)
- [Experiencing the GSC3620](#)



CHANGE LOG

This section documents significant changes from previous versions of user manual for GSC3620 Series. Only major new features or major document updates are listed here. Minor updates for corrections or editing are not documented here.

Firmware Version 1.0.5.3

- This is the initial version.



WELCOME

Thank you for purchasing Grand stream's GSC3620 FHD IP Dome Camera, the innovative powerful weatherproof Vari-focal and Auto-Focus camera. The GSC3620 is a ceiling-mounted fixed dome IP camera with a 3.6mm lens - making it an ideal device for wide-angle monitoring of nearby subjects in environments such as banks, hotels, retail stores, offices, warehouses, and building entrances. GSC3620 supports motion detection and smart infrared technology for white balance and exposure to monitor activity at night in outdoor or dark enclosed spaces. The GSC3620 can be managed with GSURF Pro, Grandstream's free video management software, along with other ONVIF-compliant video management systems. It pairs with Grandstream's video phones and GSC3570 HD intercom and facility control station for active end-point monitoring and facility control. By adding weatherproof capabilities, this is an ideal device for increasing security and facility management in any indoor or outdoor area.

Designed for both indoor and outdoor environment, the GSC3620 IP Camera ensures ease of use, integration, and deployment, with multilingual graphical user interface, provides powerful solution to professional surveillance applications.

This manual will help you to learn how to operate and manage your GSC3620 FHD Infrared Weatherproof Vari-focal and Auto-Focus, Dome Camera, and make the best use of it.



PRODUCT OVERVIEW

Feature Highlights

The following table contains the major features of the GSC3620:

Table 1: GSC3620 Features in a Glance

 <p>GSC3620</p>	<ul style="list-style-type: none"> • Motion detection • Vari-focal and Auto-Focus • Smart infrared technology for optimal white balance and exposure • Built-in PoE to power the device and provide a network connection • Alert notifications via outbound voice or video call & email screenshot • IP67-level weatherproof capability • Primary stream 1920x1080 and Secondary stream 640x480 • SIP/VoIP support for video and audio streaming to endpoints (external microphone required)
---	--

GSC3620 Technical Specifications

The following table resumes all the technical specifications including the protocols / standards supported, voice codecs, telephony features, languages, and upgrade/provisioning settings for GSC3620.

Table 2: GSC3620 Technical Specifications

Network Protocol	SIP RFC3261, TCP/IP/UDP, RTP/RTCP, HTTP/HTTPS, ARP, ICMP, DNS (A record, SRV, NAPTR), DHCP, SSH, TFTP, NTP, STUN, LLDP-MED, TLS, SRTP
Image Sensor Resolution	1/2.7" CMOS Sensor, 2 megapixels (2MP), 1920(H)x1080(V) resolution
Video Compression	H.264/H.265/JPEG/MJPEG
Supported Maximum Video Resolution	Primary Stream: 1920x1080; 1280x960; 1280x720 Secondary Stream: 1280x720; 704x576; 640x480; 352x288; 320x240
Video Output	Network
Audio	Line-In: 1 x 3.5mm, 1-50mVpp; Line-Out: 1 x 3.5mm, 560Ω, 4.0Vpp
Scanning System	Progressive



Image Configuration	Saturation, Brightness, Contrast, Sharpness, White Balance
Focal Length	2.8mm - 12mm Vari-Focal, Electronic Auto-Focus
Infrared LED	42μ x 2, up to 25M, Auto Control
Ethernet	One RJ-45 (10/100Base-T) Port with PoE
ONVIF	Yes, Profile S
Day/Night	Color/ Black &White (IR-CUT)
Motion Detection	Supported
Language Supported	Multi-Language
Privacy Mask	4 Rectangular Zones
Weatherproof Grade	Metal, IP67-level weatherproof capability
Power	DC12V±10%,1A (Power Adapter NOT Included) PoE: Support IEEE 802.3af
Temperature / Humidity	-20 °C ~ 60 °C, RH95% Max
Weight and Dimensions	Unit: 714g, Dimension: 128 x 108 (LxH) mm; Package Weigh: 900g
Compliance	FCC, CE, RCM, IC



GETTING STARTED

This chapter provides basic installation instructions including the list of the packaging contents and also information for obtaining the best performance with the GSC3620.

Equipment Packaging

Table 3: Equipment Packaging – GSC3620

GSC3620
<ul style="list-style-type: none"> • 1x GSC3620 Main Case. • 1x Drill Template • 2x Hex Keys • 1x Waterproof RJ45 Socket (5 pieces) • 3x Wall Anchors and Screws • 1x Quick Installation Guide.

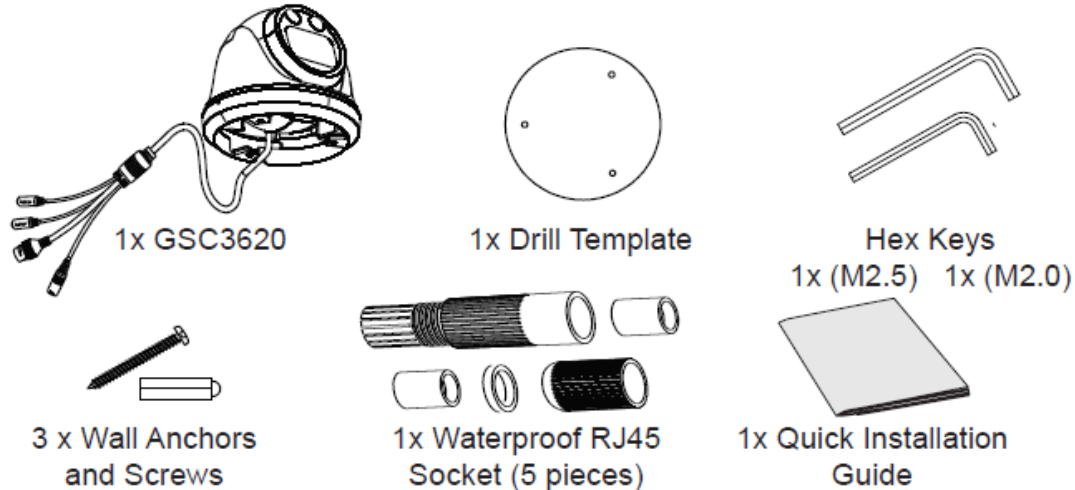

Figure 1: GSC3620 Package Content

Note:

Check the package before installation. If you find anything missing, contact your system administrator.

Powering and Connecting the GSC3620

The GSC3620 can be powered either using the right PSU (DC12V, 1A) or using a PoE switch, please refer to illustration below to do the wiring and connect the waterproof RJ45 socket:

Option A (Recommended)

1. Based on T-568B (see diagram below) to install the RJ45 plug, tighten the connector using the provided waterproof socket.

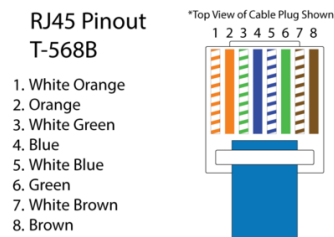

2. Connect other end of the cable into a switch supporting Power over Ethernet.

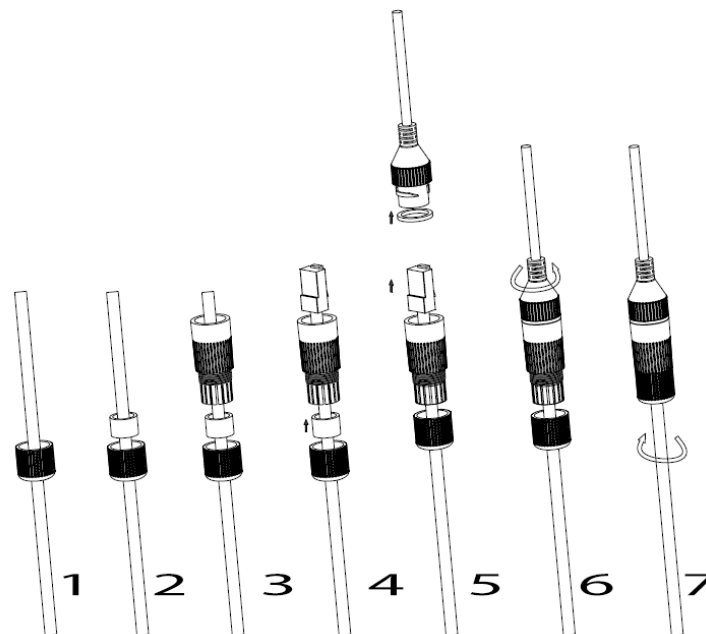

Figure 2: RJ45 plug installation

Option B

1. Wire the cable and connect it to a network switch as in the figure above.
2. Connect a 12VDC, 1A (minimum) Power Adapter (not provided) to the power socket of the GSC3620 tail cable. Make sure the polarity "+" (center) and "-" (outside) are correctly connected.



HARDWARE INSTALLATION

Mounting GSC3620

Step 1: Use supplied drill template to drill holes at ceiling. Select appropriate anchors or screws based on ceiling material.

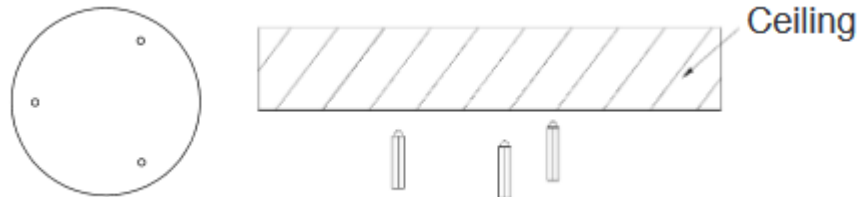

Step 2: Remove the top cover of the camera by turning it counterclockwise as shown in the figure below. Refer to the arrow and small notch on the machine body as shown below to align the machine cover.

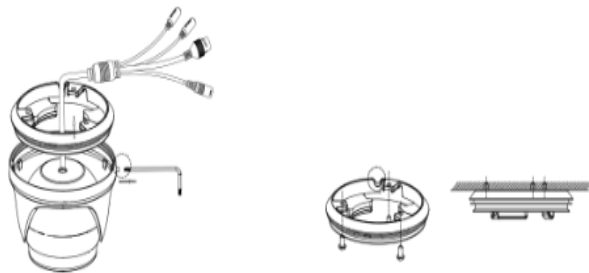

Step 4: Hold the body of camera and align to the notch as shown in the diagram, then push the body of camera into the cover of camera already mounted at the ceiling.

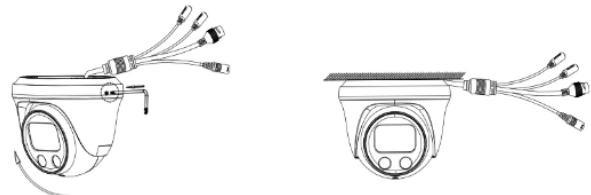

Step 3: Place the cable into the groove of camera cover, mount the cover into ceiling using provided screws as shown in below diagram. Leave the connectors of cable dangling outside the cover.



Figure 3: Mounting GSC3620

GSC3620 APPLICATION SCENARIOS

GSC3620 is very versatile infrared IP Camera, it can be used in a lot of scenarios.

LAN without Internet

For multi-room or a bigger space, multiple GSC3620 might be required. User can establish a local area network using PoE switch.

If remote access required, a router with internet access may add in.

Equipment List:

1. Several GSC3620
2. Ethernet cables
3. Switch (Static IP required to configure to IP Cameras)
4. PoE Switch (Optional, better solution)

Note: If remote access to the cameras required to view the LIVE video stream, then broadband Internet is required, and more equipment required:

5. Router (if DHCP configured than static IP is not required although still recommended)
6. iPhone or Android phone. (Application like “IP Cam Viewer”)

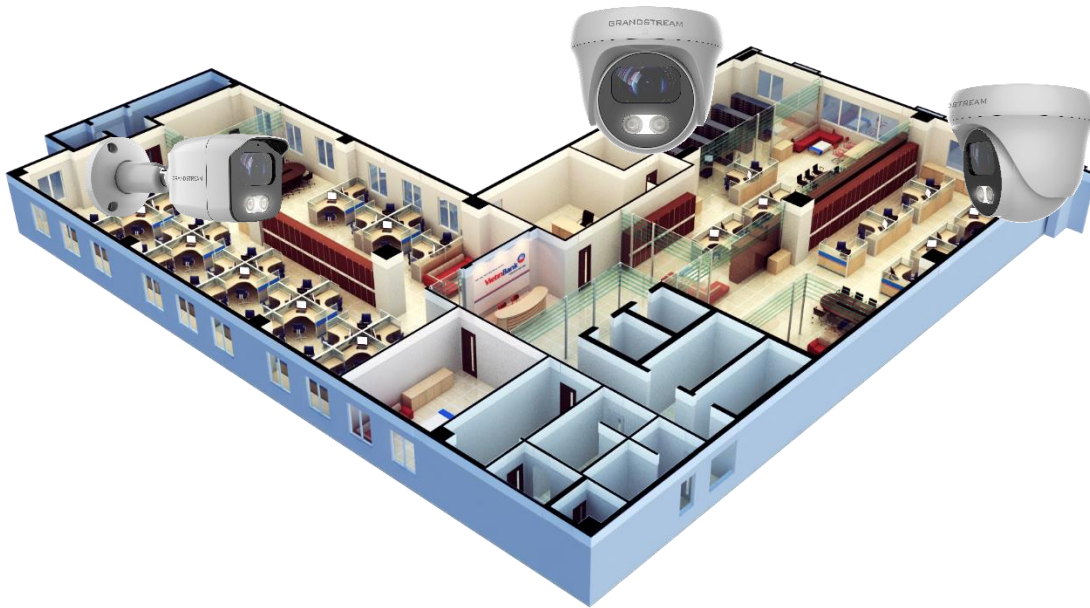

Figure 4: GSC3620 Working in LAN



LAN with Internet

For multi-room or a bigger space, with Internet access and local video recording required, following list is recommended:

Equipment List:

1. Several GSC3620
2. Ethernet cables
3. Switch (PoE Switch recommended)
4. Router
5. Broadband Internet Access (FiOS, Cable or DSL)
6. iPhone or Android phone. (Application like “IP Cam Viewer”)
7. VMS GSurf_Pro Remote Access (Optional)



Figure 5: GSC3620 working with Internet



Application Peripheral Connection

Below is the illustration of GSC3620 peripheral connections for related application.



Figure 6: Application Peripheral Connection for GSC3620

- Audio Output and Input using 3.5mm interface must match below parameters:

Audio Output	3.5mm Line-Out, 560Ω, 4.0Vpp
Audio Input	3.5mm Line-In, 1-50mVpp

- Grandstream Audio & Video Phones (GXP21xx, GRP2600 & GXV33xx) can work with GSC3620 via either Peer IP (LAN) or SIP extension (WAN). Peer to Peer (or Direct IP) works only at LAN using static IP; SIP extension requires related SIP server/proxy provided and configured.



GSC3620 WEB GUI

Note the below requirement to access/configure the GSC3620:

- Internet Browser like Firefox, Chrome, Microsoft Internet Explorer.
- DHCP server enabled on the network.

Two ways exist for Windows user to get access to the GSC3620:

UPnP

By default, the GSC3620 has the UPnP feature turned ON. For customers using Windows network with UPnP turned on (most SOHO routers support UPnP), it is easy to access the GSC3620:

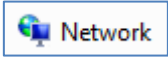
1. Find the “Network” icon  on the windows Desktop.
2. Click the icon to get into the “Network”, the GSC3620s will list as “Other Devices” shown. Refresh the pages if nothing displayed. Otherwise, the UPnP may not be active in the network.
3. Click on the displayed icon of related GSC3620, the default browser (e.g.: Internet Explorer, Firefox, or Chrome) will open and connect directly to the login webpage.

GS Search

Double check the requirements then follow the below steps to access the GSC3620 WEB configuration page:

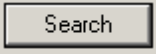
1. Download and install GS_Search tool from the link below:
https://www.grandstream.com/products/tools/surveillance/GS_Search.zip
2. Run the Grandstream GS_Search tool.
3. Click on  button to start device detection.
4. The detected devices will appear in the output field as below.



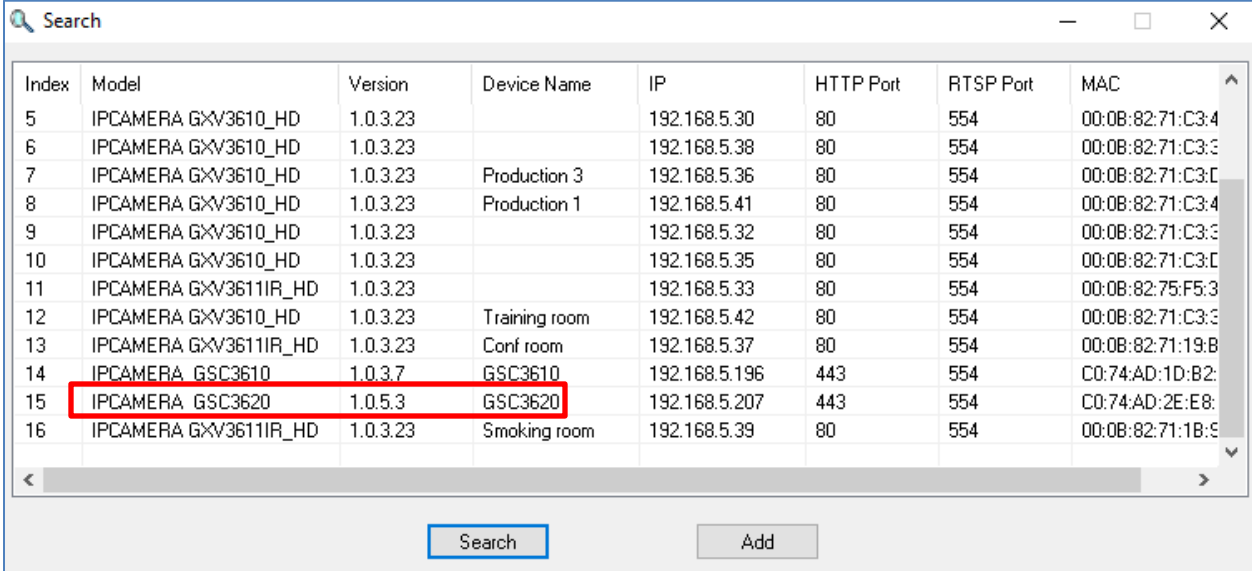

Index	Model	Version	Device Name	IP	HTTP Port	RTSP Port	MAC
5	IPCAMERA_GXV3610_HD	1.0.3.23		192.168.5.30	80	554	00:08:82:71:C3:4
6	IPCAMERA_GXV3610_HD	1.0.3.23		192.168.5.38	80	554	00:08:82:71:C3:3
7	IPCAMERA_GXV3610_HD	1.0.3.23	Production 3	192.168.5.36	80	554	00:08:82:71:C3:4
8	IPCAMERA_GXV3610_HD	1.0.3.23	Production 1	192.168.5.41	80	554	00:08:82:71:C3:4
9	IPCAMERA_GXV3610_HD	1.0.3.23		192.168.5.32	80	554	00:08:82:71:C3:3
10	IPCAMERA_GXV3610_HD	1.0.3.23		192.168.5.35	80	554	00:08:82:71:C3:4
11	IPCAMERA_GXV3611IR_HD	1.0.3.23		192.168.5.33	80	554	00:08:82:75:F5:3
12	IPCAMERA_GXV3610_HD	1.0.3.23	Training room	192.168.5.42	80	554	00:08:82:71:C3:3
13	IPCAMERA_GXV3611IR_HD	1.0.3.23	Conf room	192.168.5.37	80	554	00:08:82:71:19:8
14	IPCAMERA_GSC3610	1.0.3.7	GSC3610	192.168.5.196	443	554	C0:74:AD:1D:B2:
15	IPCAMERA_GSC3620	1.0.5.3	GSC3620	192.168.5.207	443	554	C0:74:AD:2E:E8:
16	IPCAMERA_GXV3611IR_HD	1.0.3.23	Smoking room	192.168.5.39	80	554	00:08:82:71:1B:5

Figure 7: GS_Search tool

- Double click on the detected device. The default browser (Chrome in this example) will open to display the camera's login web interface.

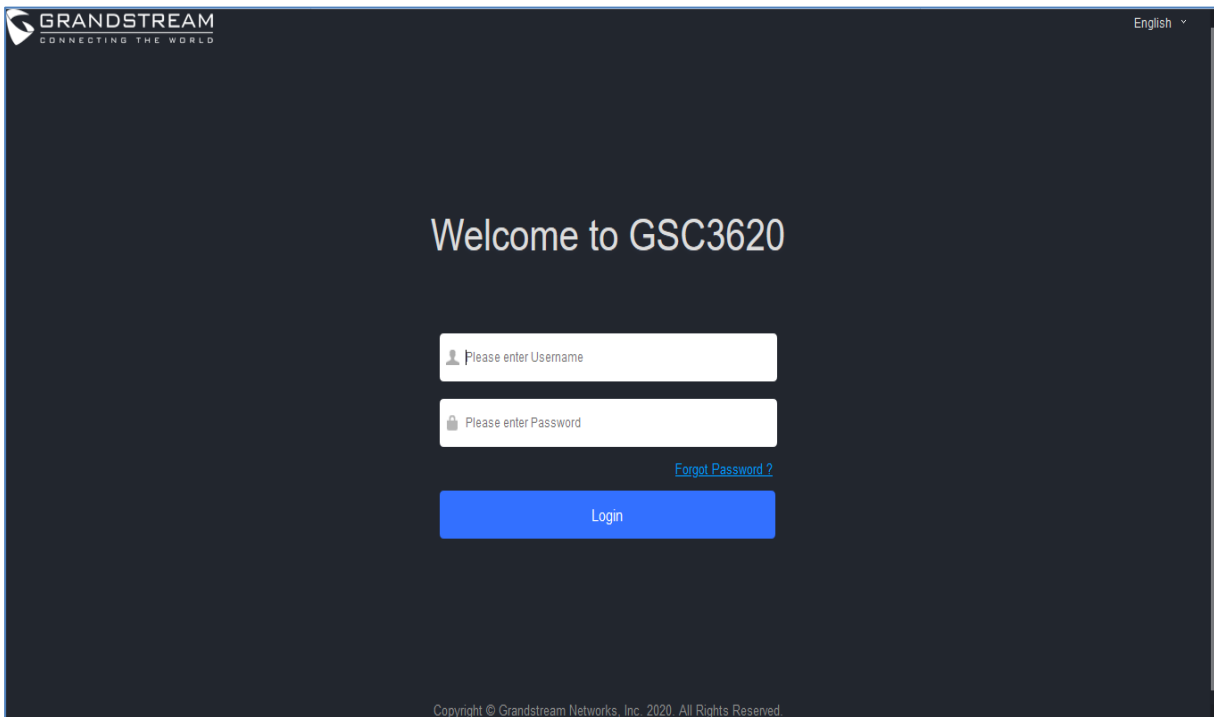

Figure 8: GSC3620 Login Page

- When clicking on the “Language” drop down, supported languages will be displayed. Click to select the related webpage display language. (Current firmware supports only English as default and simplified Chinese).
- Username and password are required to login the camera to manage the device.



The default username is “admin”; the default password is a random password printed in a sticker which can be found on the camera body or cable.

- The default connection is via HTTPS. Once input the correct username and password, the device configuration webpage will be available.

Web GUI Settings

The GSC3620 embedded Web server responds to HTTP/HTTPS GET/POST requests. Embedded HTML pages allow users to configure the application phone through a Web browser such as Microsoft’s IE, Mozilla, Firefox, Google Chrome and etc.

- Once logged in successfully to the GSC3620, the browser will display the GUI as shown below:

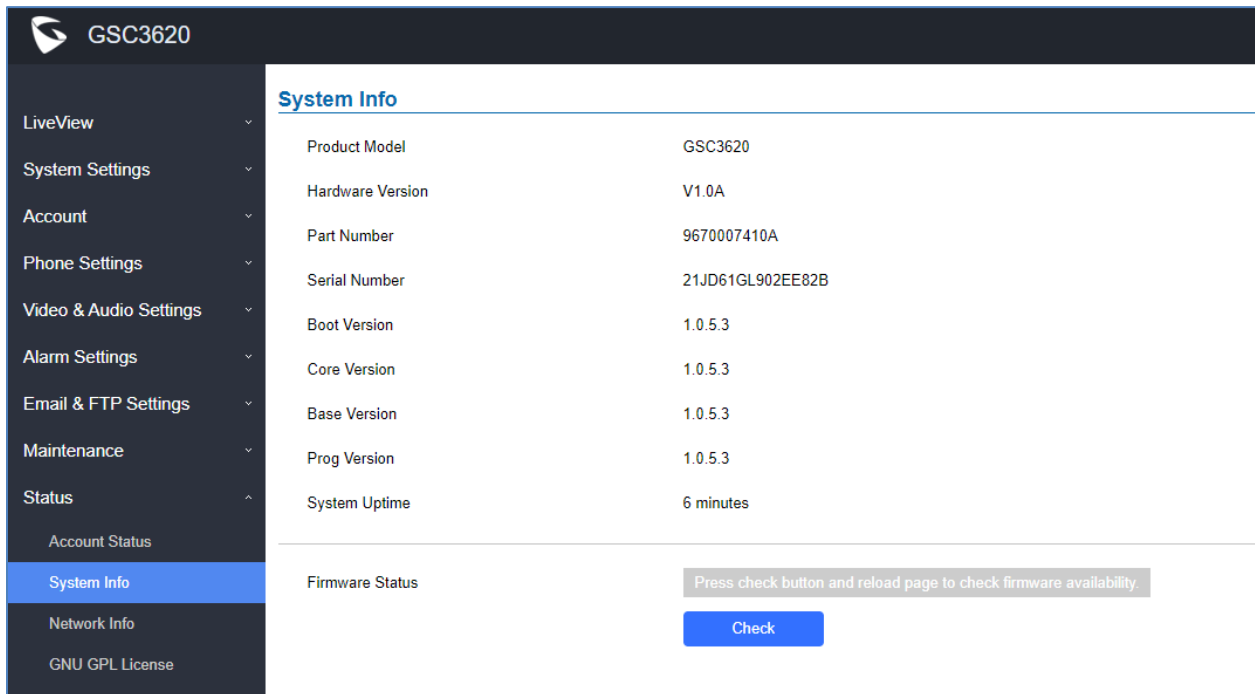

Figure 9: GSC3620 Web GUI

Table 4: GSC3620 WEB GUI Sections

Fields	Description
LiveView	Access to live view stream page.
1	Play the primary stream.
2	Play the secondary stream.



System Settings	Access to “System Settings” page.
Account	Access to “Account” configuration page.
Phone Settings	Access to “Phone Settings” configuration page.
Video & Audio Settings	Access to “Video & Audio settings” page.
Alarm Settings	Access to “Alarm settings” page.
Email & FTP Settings	Access to “Email & FTP Settings” page.
Maintenance	Access to “Maintenance” page.
Status	Click to enter “Status” page.



GSC3620 SETTINGS

Live View Page

This page allows users to view the live video of the GSC3620.



Figure 10: Live View

Two streams are available:

- **Primary video stream:** 1920*1080 resolution, recommended for continuous full HD recording
- **Secondary video stream:** 640*480 resolution, recommended for SIP/VoIP video calls

Note: Make sure to download/Install the browser video plugin to have access to the Live View and video stream tools.

Vari-focal and Auto-Focus Settings

At the “LiveView” page, sliding the “ZOOM” bar left or right to zoom out/in the lens; click “Focus+/-” to fine tune the focus; or click “One key focus” to let system auto-focus the scene; click “initialize lens” to go back to default.



Figure 11: GSC3620 Zoom



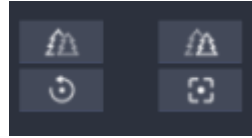





Figure 12: GSC3620 Auto-Focus Settings

Table 5: GSC3620/GSC362 Auto-Focus Settings Description

Fields	Description
	Focus+
	Focus-
	One Key Focus
	Initialize Lens

Notes:

- After adjusting the focal length of the lens or click “One Key Focus”, the device will automatically adjust the image definition (no other lens operation allowed during the auto-focus process).
- Due to the scene limitation, the effect of “one key focus” may not always be satisfied. When this happened, it is recommended manually click the “Focus+/-“ button to fine tune and complete the focus operation.
- If after several round of zoom and focus, the image is still not clear, please click “Initialize lens” to reset the lens by removing the accumulated errors of the lens.

System Settings

This page allows users to configure date and time, network settings as well as access method to the GSC3620 and password for accessing the Web GUI.

Date & Time Settings

This page allows users to adjust system date and time.



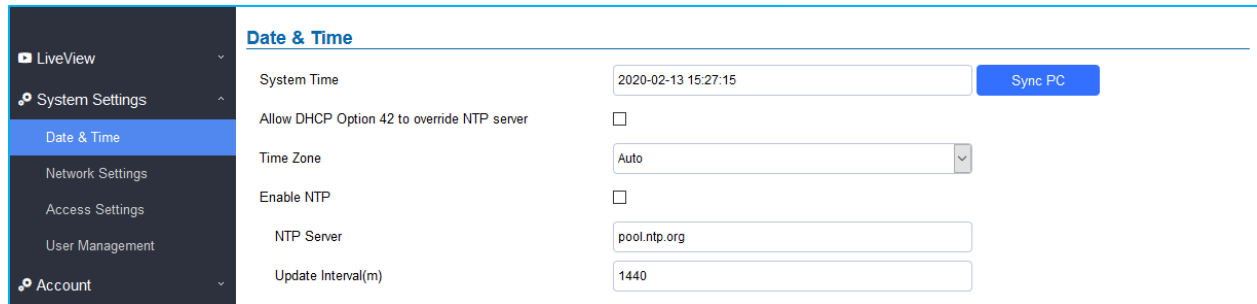

Figure 13: Date & Time Page

Table 5: Date & Time

System Time	Displays the current system time.
Allow DHCP Option 42 to override NTP server	Defines whether DHCP Option 42 should override NTP server or not. When enabled, DHCP Option 42 will override the NTP server if it is set up on the LAN. The default setting is “Yes”.
Sync PC	Clicks to synchronize current time with the computer.
Time Zone	Selects from drop down menu the preferred time zone. Default is “Auto”
Enable NTP	Enables NTP to synchronize device time.
NTP Server	Configures the domain name of NTP server. Default is “pool.ntp.org”
Update Interval	Configures the Interval (in minutes) to retrieve updates from the NTP server.

Network Settings

This page allows users to set either a static or DHCP IP address to access the unit.



- LiveView
- System Settings
 - Date & Time
 - Network Settings
 - Access Settings
 - User Management
- Account
- Phone Settings
- Video & Audio Settings
- Alarm Settings
- Email & FTP Settings
- Maintenance
- Status

Basic Settings

IP Address Config

IP Address Mode DHCP Static IP

IP Address

Subnet Mask

Gateway

DNS Config

DNS Address Type Dynamic DNS Static DNS

DNS Server 1

DNS Server 2

LLDP Config

Enable LLDP Disable Enable

Layer 2 QoS 802.1Q/VLAN Tag

Layer 2 QoS 802.1p Priority Value

Figure 14: Basic Settings Page

Table 6: Basic Settings

IP Address Mode	Selects DHCP or Static IP. Default DHCP. (Static recommended)
IP Address	Configures the Static IP of the GSC3620.
Subnet Mask	Configures the Associated Subnet Mask.
Gateway	Configures the Gateway IP address.
DNS Address Type	Specifies the DNS type used: Dynamic DNS or Static DNS.
DNS Server 1	Configures DNS Server 1 IP address.
DNS Server 2	Configures DNS Server 2 IP address.
Enable LLDP	Controls the LLDP (Link Layer Discovery Protocol) service. The default setting is "Enabled".
Layer 2 QoS 802.1Q/VLAN Tag	Assigns the VLAN Tag of the Layer 2 QoS packets. Default value is 0.
Layer 2 QoS 802.1p Priority Value	Assigns the priority value of the Layer2 QoS packets. Default value is 0.



Notes:

- If the device is behind SOHO (Small Office Home Office) router with port forwarding configured for remote access, static IP should be used to avoid IP address changes after router reboot.
- TCP port above 5000 is suggested to Port forward HTTP for remote access, due to some ISP would block port 80 for inbound traffic. For example, change the default HTTP port from 80 to 8088, to make sure the TCP port will not be blocked.
- In addition to HTTP port, RTSP port is also required to configure via port forwarding, so that the remote party can view the video stream.

Access Settings

This page configures the GSC3620 access control parameters.

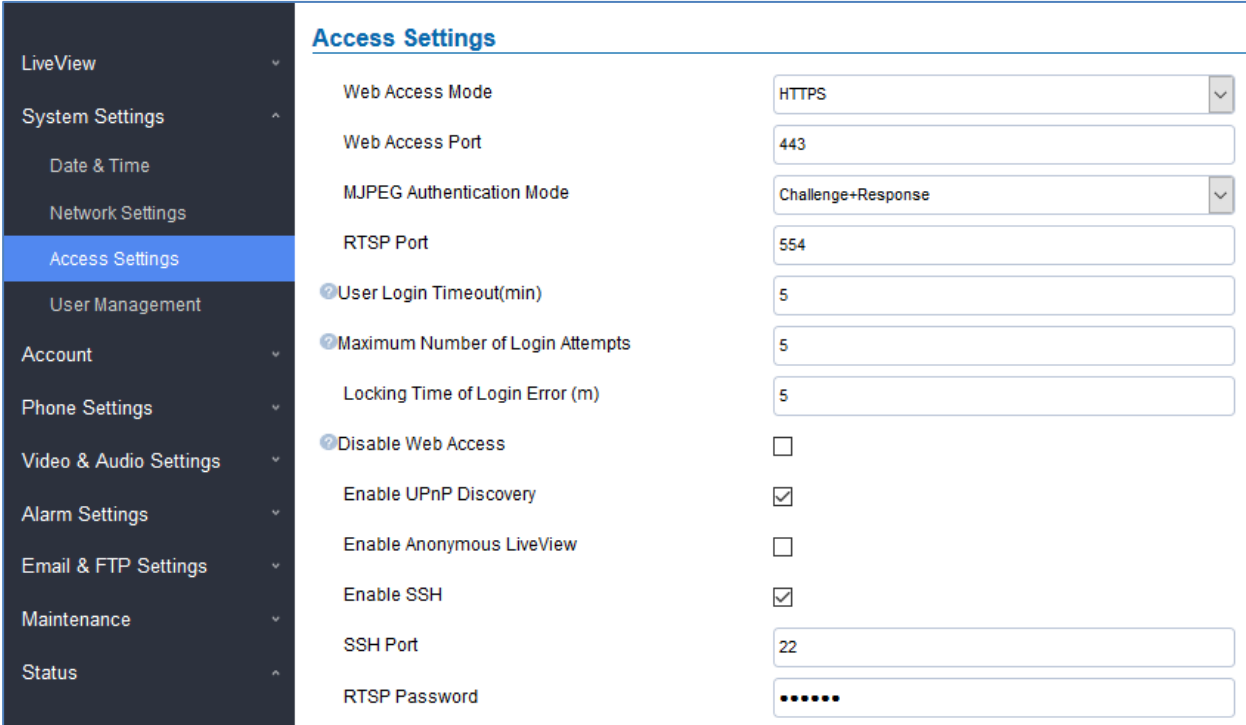

Access Settings	
Web Access Mode	HTTPS
Web Access Port	443
MJPEG Authentication Mode	Challenge+Response
RTSP Port	554
User Login Timeout(min)	5
Maximum Number of Login Attempts	5
Locking Time of Login Error (m)	5
Disable Web Access	<input type="checkbox"/>
Enable UPnP Discovery	<input checked="" type="checkbox"/>
Enable Anonymous LiveView	<input type="checkbox"/>
Enable SSH	<input checked="" type="checkbox"/>
SSH Port	22
RTSP Password

Figure 15: Access Settings Page

Table 7: Access Settings

Web Access Mode	Selects the access mode to the Web GUI either HTTP or HTTPS.
Web Access Port	Specifies the TCP port for Web Access, default 443.



MJPEG Authentication Mode	<p>Allows 3rd party system integrator or developers to implement related application for users. By default, this feature is disabled and use more secured “Challenge+Response” mode.</p> <p>If enabled, user can send HTTP API with correct credentials to retrieve MJPEG video stream or JPEG snapshot from GSC.</p> <p>Notes:</p> <p>1- The MJPEG stream can be retrieved via the following URL HTML based → http(s)://admin:password@IP_GSC3620:Port/jpeg/mjpeg.html Stream → http(s)://admin:password@ip:port/jpeg/stream</p> <p>2- The MJPEG stream retrieved via the methods above is running on the background and cannot be tuned. If users want more flexibility, they can use the three configurable video streams as shown on [Retrieving Video Streams]</p>
RTSP Port	<p>Specifies RTSP port for media stream, default TCP port 554.</p>
User Login Timeout(min)	<p>If no action is made within this time the GSC3620 will logout from the Web GUI, range is between 3 and 60. Default is 5.</p>
Maximum Number of Login Attempts	<p>Specifies the allowed login times error limit, if the unsuccessful login attempts exceed this value, the GSC3620 webGUI will be locked for the time specified in Login Error Lock Time. Default is 5.</p>
Locking Time of Login Error (m)	<p>Specifies how long the GSC3620 is locked before a new login attempt is allowed. Default is 5.</p>
Disable Web Access	<p>Allow or deny the web access to the GSC3620. (HTTP API do not take effect when this option is enabled).</p> <p>Note: If both WebUI and SSH are disabled, GSC3620 will get blocked and not be able to be accessed. Only two ways to get it back:</p> <ol style="list-style-type: none"> 1. Re-provisioned by ITSP or Service Provider (by adjusting the related parameters) 2. Hard Reset (GSC3620 has to be offline and uninstalled to perform this hard reset).
Enable UPnP Discovery	<p>UPnP (or mDNS) function for local discovery. Default setting is enabled.</p>
Enable Anonymous LiveView	<ol style="list-style-type: none"> 1. When enabled, user can display the camera stream from without admin credentials using the following URL scheme: http(s)://GSC3620_IP:port/videoview.html 1. User can also retrieve a real-time snapshot without admin credentials using the following URL: http(s)://IP:port/anonymous/snapshot/view.html



	Or with: https://IP_GSC3620:Port/anonymous/snapshot/view.jpg 2. To retrieve video stream via RTSP, users can use the following format: <code>rtsp://IP_GSC3620:Port/X</code> where X=0,4 for 1 st , 2 nd streams, respectively.
Enable SSH	Allows SSH access for remote secured configuration purposes (restart, upgrade, provision...)
SSH Port	Specifies the SSH port. Default setting is 22.
RTSP Password	This password can be used for RTSP stream display.

Retrieving Video Streams

RTSP Stream

To retrieve video stream via RTSP, users can use the following format:

rtsp://admin:password@IP_GSC3620:Port/X where X=0,4 for 1st, 2nd streams respectively

MJPEG Stream

The GSC3620 supports MJPEG Stream live viewing via HTTP API commands, this can be used without installing the Live view browser plugin. Users can deploy two methods to retrieve MJPEG stream depending on *MJPEG Authentication Mode*, which can be set under following path:

Web UI → System Settings → Access Settings

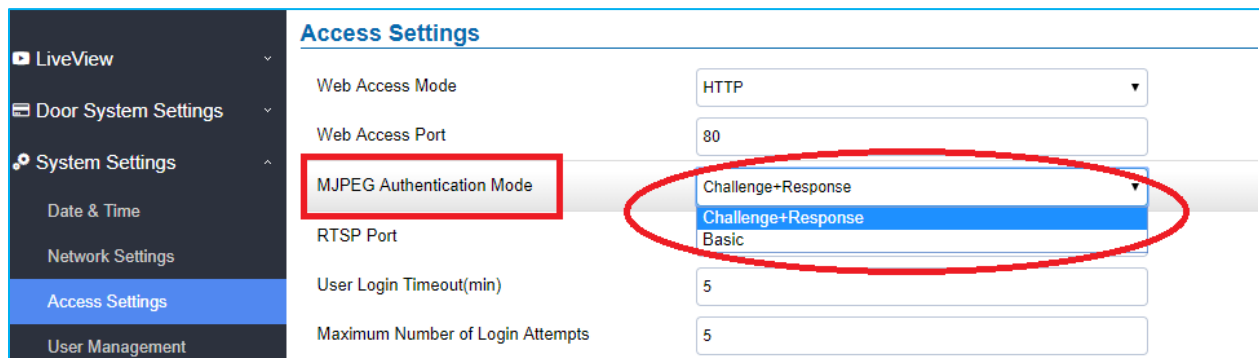

Figure 16: MJPEG Authentication Mode

A. “Challenge+Response” MJPEG Authentication Mode:

In order to get live view stream using MJPEG stream over HTTP command on this mode, please follow below steps:

1. In browser type in **`http(s)://IP_Address_GSC3620:Port/jpeg/mjpeg.html`**



Example: <https://192.168.5.146/jpeg/mjpeg.html>

2. The browser will pop up the window above asking for credentials, user needs to enter admin credential.
3. The browser will show MJPEG stream (720p).

B. “Basic” MJPEG Authentication Mode:

Please follow below steps in order to take a snapshot via HTTP commands:

1. In browser type in: **http(s)://admin:password@IP_Address_GSC:Port/jpeg/mjpeg.html**

Example: <https://admin:admin@192.168.5.157:443/jpeg/mjpeg.html>

2. The browser will show MJPEG stream (720p).

Note: Similar command can be applied to open source application like **VLC Media Player** to retrieve H.264 video stream with better quality: **rtsp://admin:password@IP_GSC3620:Port/X**

Where **X=0,4** corresponded to **1st, 2nd** video stream

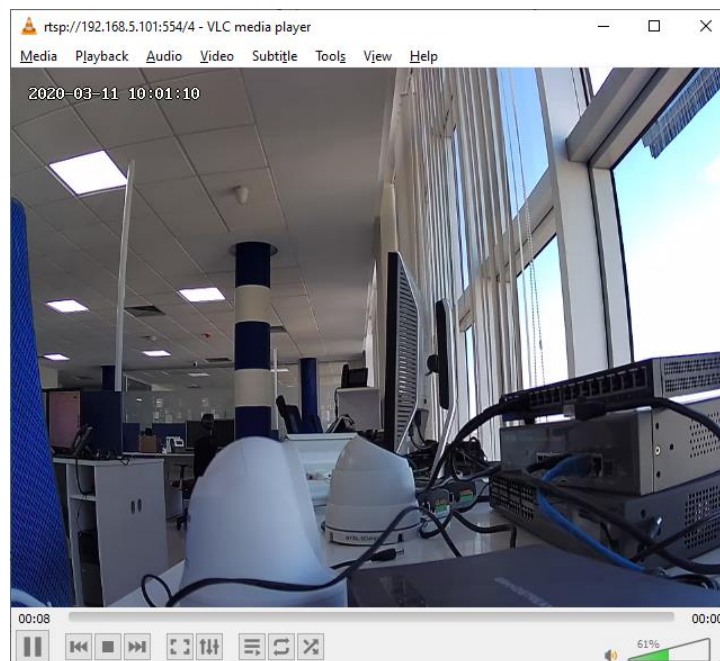

Figure 17: RTSP steam display using VLC

User Management

This page allows users to configure the password for administrator. Since this is a door system which must be a secure product, the use is only limited to administrator.



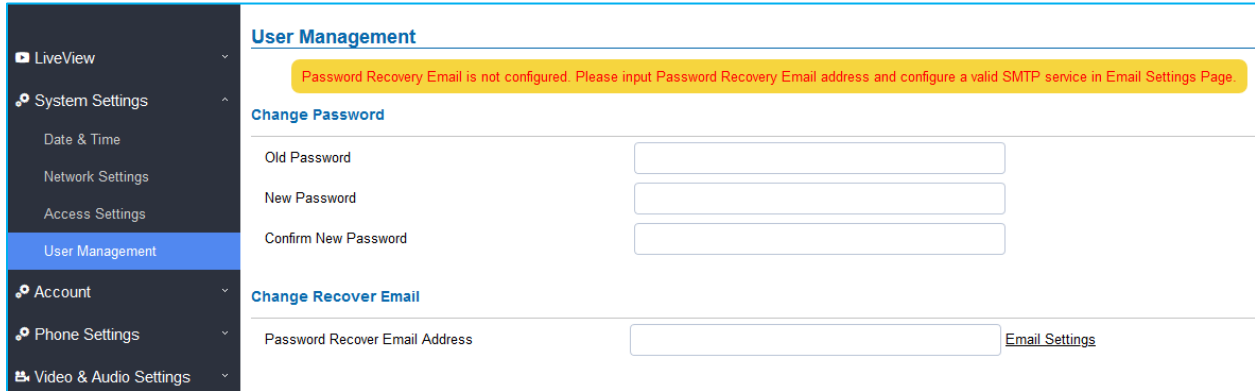

Figure 18: User Management Page

Table 8: User Management

Old Password	Old password must be entered to change new password.
New Password	Fill in the revised new password in this field.
Confirm User Password	Re-enter the new password for verification, must match.
Password Recovery Email Address	This option is highly recommended , as if the password is lost, you can recover it on the configured Email address. Note: Make sure to configure SMTP Email Settings under “ Email Settings ”

Note:

- When trying to change the password, users need to set the “Password Recovery Email” which should be a valid Email account configurable under “**Email & FTP Settings → Email Settings**” to retrieve the email before the new admin password take effect as displayed on the following screenshot.

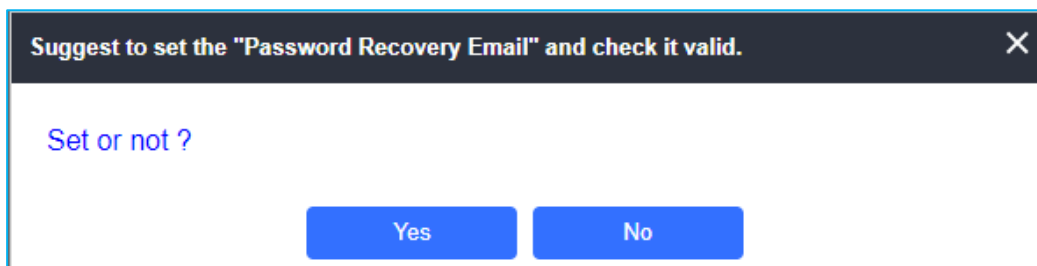

Figure 19: Password Recovery Email



Account

The GSC3620 supports 4 SIP accounts and 4 lines, this section covers the configuration of basic and advanced sip settings for each account.

Account 1 - 4

This page allows the administrator to configure the SIP account basic and advanced settings for each SIP account:

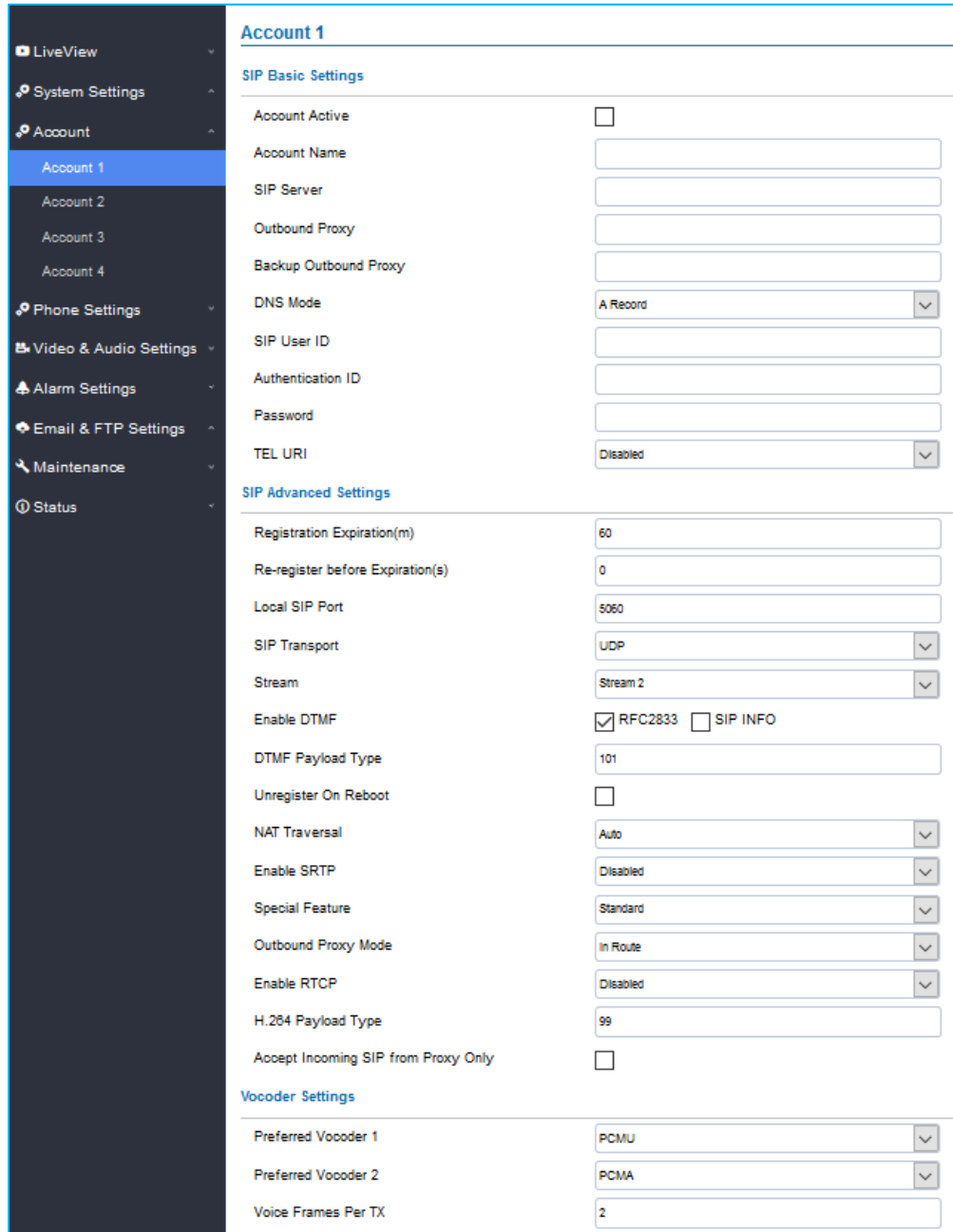

Account 1	
SIP Basic Settings	
Account Active	<input type="checkbox"/>
Account Name	<input type="text"/>
SIP Server	<input type="text"/>
Outbound Proxy	<input type="text"/>
Backup Outbound Proxy	<input type="text"/>
DNS Mode	A Record <input type="button" value="v"/>
SIP User ID	<input type="text"/>
Authentication ID	<input type="text"/>
Password	<input type="text"/>
TEL URI	Disabled <input type="button" value="v"/>
SIP Advanced Settings	
Registration Expiration(m)	60 <input type="text"/>
Re-register before Expiration(s)	0 <input type="text"/>
Local SIP Port	5060 <input type="text"/>
SIP Transport	UDP <input type="button" value="v"/>
Stream	Stream 2 <input type="button" value="v"/>
Enable DTMF	<input checked="" type="checkbox"/> RFC2833 <input type="checkbox"/> SIP INFO
DTMF Payload Type	101 <input type="text"/>
Unregister On Reboot	<input type="checkbox"/>
NAT Traversal	Auto <input type="button" value="v"/>
Enable SRTP	Disabled <input type="button" value="v"/>
Special Feature	Standard <input type="button" value="v"/>
Outbound Proxy Mode	In Route <input type="button" value="v"/>
Enable RTCP	Disabled <input type="button" value="v"/>
H.264 Payload Type	99 <input type="text"/>
Accept Incoming SIP from Proxy Only	<input type="checkbox"/>
Vocoder Settings	
Preferred Vocoder 1	PCMU <input type="button" value="v"/>
Preferred Vocoder 2	PCMA <input type="button" value="v"/>
Voice Frames Per TX	2 <input type="text"/>

Figure 20: SIP Account Settings Page



Table 9: SIP Account Basic & Advanced Settings

SIP Basic Settings	
Account Active	This field indicates whether the account is active. Default setting is "Yes".
Account Name	Configures the SIP account name used for identification.
SIP Server	Configures the FQDN or IP of the SIP server from VoIP service provider or local IPPBX.
Outbound Proxy	Configures the IP address or the domain name of the outbound proxy, media gateway, or session border controller. It is used by the GSC for firewall or NAT penetration in different network environments. If a symmetric NAT is detected, STUN will not work and only an outbound proxy can provide a solution.
Backup Outbound Proxy	Configures the backup outbound proxy to be used when the "Outbound Proxy" registration fails. By default, this field is left empty.
DNS Mode	Configure which DNS mode will be used to translate the SIP Server FQDN (Default value is A Record): <ul style="list-style-type: none"> • A Record. • SRV. • NAPTR/SRV.
SIP User ID	Configures the SIP username or telephone number from ITSP. Note: Letters, digits and special characters including @ are supported.
Authenticate ID	Configures the Authenticate ID used by SIP proxy.
Password	Sets the Authenticate password used by SIP proxy. Note: For security reasons, the SIP password is invisible on the web UI.
TEL URI	Select "User=Phone" or "Enabled" from the dropdown list. If the SIP account has an assigned PSTN telephone number, this field should be set to "User=Phone". Then a "User=Phone" parameter will be attached to the Request-Line and "TO" header in the SIP request to indicate the E.164 number. If set to "Enable", "Tel:" will be used instead of "SIP:" in the SIP request. The default setting is "Disable".
SIP Advanced Settings	
Registration Expiration (m)	Sets the registration expiration time. Default setting is 60 minutes. Valid range is from 1 to 64800 minutes.
Re-register before Expiration (s)	Specifies the time frequency (in seconds) that the GSC3620 sends re-registration request before the Register Expiration. The default value is 0. Range is from 0-64800 seconds.



Local SIP Port	Sets the local SIP port. Default setting is 5060 for Account 1, 5062 for Account 2, 5064 for Account 3, 5066 for Account 4.
SIP Transport	Chooses the SIP transport protocol. UDP, TCP or TCP/TLS. Default setting is UDP.
Stream	Select the Video stream to be used by the GSC3620 when call is made from this SIP Account. Default is Stream 2.
Enable DTMF	Specifies the mechanism to transmit DTMF digits. There are 2 supported modes: <ul style="list-style-type: none"> • RFC2833 sends DTMF with RTP packet. Users can check the RTP packet to see the DTMFs sent as well as the number pressed. • SIP INFO uses SIP INFO to carry DTMF. Default setting is "RFC2833"
DTMF Payload Type	Configures the payload type for DTMF using RFC2833. Default value is 101. Range: 96~127.
Unregister on Reboot	Allows the SIP user's registration information to be cleared when the GSC reboots. The SIP REGISTER message will contain "Expires: 0" to unbind the connection.
NAT Traversal	<p>This parameter configures whether the NAT traversal mechanism is activated. Users could select the mechanism from No, STUN, Keep-alive, UPnP, Auto. The default setting is "No".</p> <p>If set to "STUN" and STUN server is configured, the GSC will route according to the STUN server. If NAT type is Full Cone, Restricted Cone or Port-Restricted Cone, the unit will try to use public IP addresses and port number in all the SIP&SDP messages.</p> <p>The GSC will send empty SDP packet to the SIP server periodically to keep the NAT port open if it is configured to be "Keep-alive". Configure this to be "No" if an outbound proxy is used. "STUN" cannot be used if the detected NAT is symmetric NAT. If the firewall and the SIP device behind the firewall are both able to use UPnP, it can be set to "UPnP". Both parties will negotiate to use which port to allow SIP through.</p>
Enable SRTP	Enable SRTP mode based on your selection from the drop-down menu. The default setting is " Disabled ", the two other modes are " Enabled but Not Forced " and " Enabled and Forced ".
Special Feature	Configures GSC settings to meet different vendors' server requirements. Users can choose from Standard, BroadSoft or Telefonica Spain. The default setting is "Standard".



Outbound Proxy Mode	<p>In route: outbound proxy FQDN is placed in route header. This is used for the SIP Extension to notify the SIP server that the device is behind a NAT/Firewall.</p> <p>Always sent to: SIP messages will always be sent to Outbound proxy.</p> <p>Not in route: remove the Route header from SIP requests.</p>
Enable RTCP	<p>This option allows 3rd party Service Provider or Cloud Solution to monitor the operation status of the GSC3620 by using related SIP Calls.</p> <p>By default, it is disabled. Users can choose either RTCP or RTCP-XR.</p>
H.264 Payload Type	<p>The H.264 payload type can now be configured to be compatible with 3rd party video phones, as well as other advanced SIP settings, to easy system integration process. Default is 99.</p>
Accept Incoming SIP from Proxy Only	<p>When set to “Yes”, the SIP address of the Request URL in the incoming SIP message will be checked. If it does not match the SIP server address of the account, the call will be rejected. The default setting is disabled.</p>
Vocoder Settings	
Preferred Vocoder 1	<p>Select audio codec to prioritize. Supported codecs are: PCMU and PCMA.</p>
Preferred Vocoder 2	<p>Select the second audio codec PCMU or PCMA.</p>
Voice Frame Per TX	<p>Configures the number of voice frames transmitted per packet. When configuring this, it should be noted that the “ptime” value for the SDP will change with different configurations here. This value is related to the codec used and the actual frames transmitted during the in-payload call. For end users, it is recommended to use the default setting, as incorrect settings may influence the audio quality. Range is from 1-64. The default setting is 2.</p>



Phone Settings

The phone settings allow users to configure the GSC3620 phone settings and the White list for all the SIP accounts.

Phone Settings

This page allows users to configure the GSC3620 phone settings.

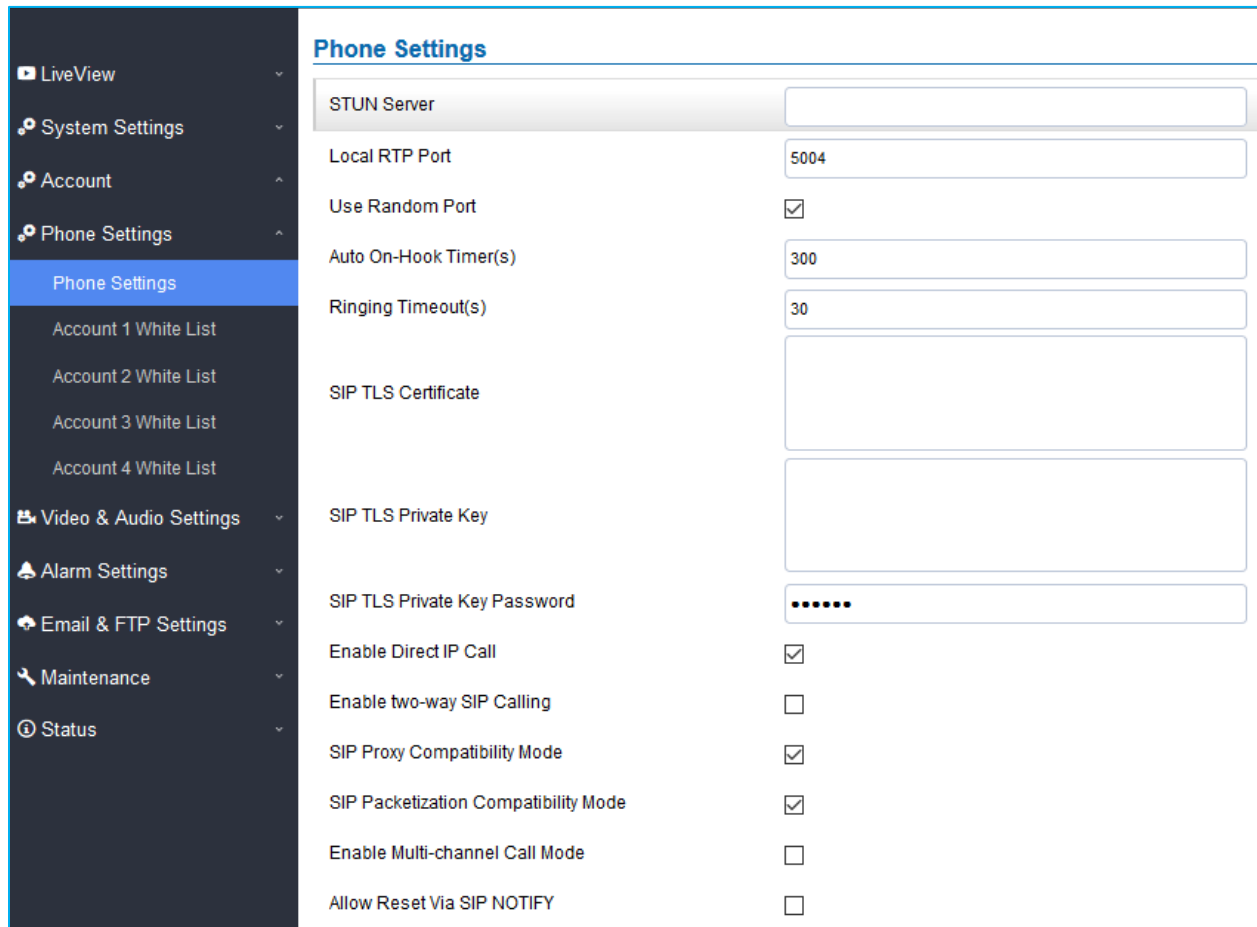

Phone Settings	
STUN Server	<input type="text"/>
Local RTP Port	<input type="text" value="5004"/>
Use Random Port	<input checked="" type="checkbox"/>
Auto On-Hook Timer(s)	<input type="text" value="300"/>
Ringing Timeout(s)	<input type="text" value="30"/>
SIP TLS Certificate	<input type="text"/>
SIP TLS Private Key	<input type="text"/>
SIP TLS Private Key Password	<input type="password" value="....."/>
Enable Direct IP Call	<input checked="" type="checkbox"/>
Enable two-way SIP Calling	<input type="checkbox"/>
SIP Proxy Compatibility Mode	<input checked="" type="checkbox"/>
SIP Packetization Compatibility Mode	<input checked="" type="checkbox"/>
Enable Multi-channel Call Mode	<input type="checkbox"/>
Allow Reset Via SIP NOTIFY	<input type="checkbox"/>

Figure 21: Phone Settings Page

Table 10: Phone Settings

STUN Server	Configures the STUN server FQDN or IP. If the device is behind a non-symmetric router, STUN server can help to penetrate & resolve NAT issues.
Local RTP Port	Sets the local RTP port for media. Default setting is 5004. Range between 1024~65400.



Use Random Port	<p>Forces the GSC3620 to use random ports for both SIP and RTP messages. This is usually necessary when multiple units are behind the same full cone NAT. The default setting is “Disabled”</p> <p>Note: This parameter must be set to “Disabled” for Direct IP Calling to work.</p>
Auto On-Hook Timer	<p>Configures the auto on-hook timer (in seconds) for automatic disconnecting the SIP call. Default setting is 300. Range between 0~65535.</p>
Ring Timeout(s)	<p>Specifies the Ring timeout, when no reply is returned from the called party after exceeding this field, the GSC3620 will hang up the call. The value is in the range of 0s – 90s. By default, it is “30” seconds.</p>
SIP TLS Certificate	<p>Input the TLS certificate here for encryption.</p>
SIP TLS Private Key	<p>Input private key here for TLS security protection.</p>
SIP TLS Private Key Password	<p>Specifies the password for SIP TLS private Key.</p>
Enable Direct IP Call	<p>Accepts peer-to-peer IP call (over UDP only) without SIP server. Default is “Enabled”.</p>
Enable two-way SIP Calling	<p>Allows the user to enable/disable the alarm sound during a SIP call triggered by doorbell pressing.</p>
SIP Proxy Compatibility Mode	<p>Enables more proxy compatibility with cost of bandwidth, the SIP call will send audio no matter what.</p>
SIP Packetization Compatibility Mode	<p>When enabled, the GSC3620 will have in SDP “packetization-mode = 0”. This is required when the device is interacting with legacy video phones that only accepts this value to decode the RTP.</p>
Enable Multi-channel Call Mode	<p>This feature allows the device to receive multiple calls at the same time, with one active and others on hold (up to 4 calls maximum).</p>
Allow Reset Via SIP NOTIFY	<p>Allows to factory reset the devices directly through SIP Notify.</p> <p>If “Allow Reset Via SIP NOTIFY” is “check”, then once the GSC3620 receives the SIP NOTIFY from the SIP server with Event: reset, the device will perform a factory reset after authentication.</p> <p>This authentication can be either with:</p> <ul style="list-style-type: none"> • The admin password if no SIP account is configured on the unit. • The SIP User ID and Password credentials of the SIP account if configured on the unit. <p>Default is unchecked (disabled).</p>



Account [1-4] White List

This page allows users to configure the white list per account, which is a phone number or extension list that can call the GSC3620. (The call will be automatically answered when calling from a phone set on the white list, and all other inbound calls will be blocked), the user can configure up to 30 white phone numbers per SIP account. Moreover, besides numbers associated to active cards, and numbers on the "Number Called When Doorbell Pressed" setting, all whitelisted numbers can open door remotely by using the respective PIN code.

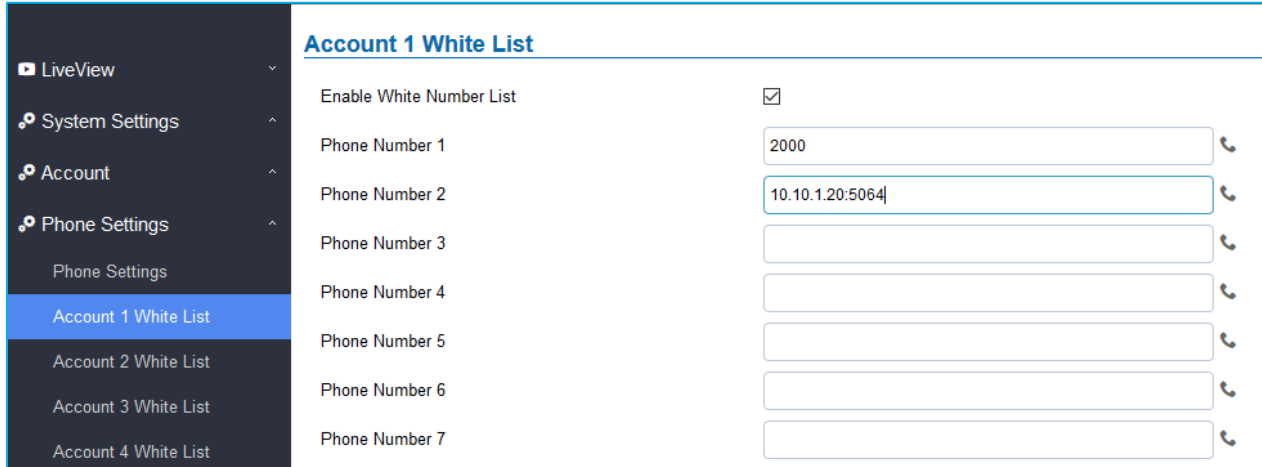

Figure 22: White List Page

The table below gives a brief overview of the options:

Table 11: White List

Enable White Number List	Enables the White List feature.
Phone Number 1 - 30	<p>Adds a new phone number (or IP address) to the white list.</p> <p>Notes:</p> <ul style="list-style-type: none"> When using IP addresses, the port number should be appended (default 5060). Only the whitelisted numbers/IPs can open door remotely using PIN Code when calling GSC3620.

Video & Audio Settings

The audio and videos settings allow users to configure the video / audio codecs, videos resolution, CMOS settings and audio related settings.



Video Settings

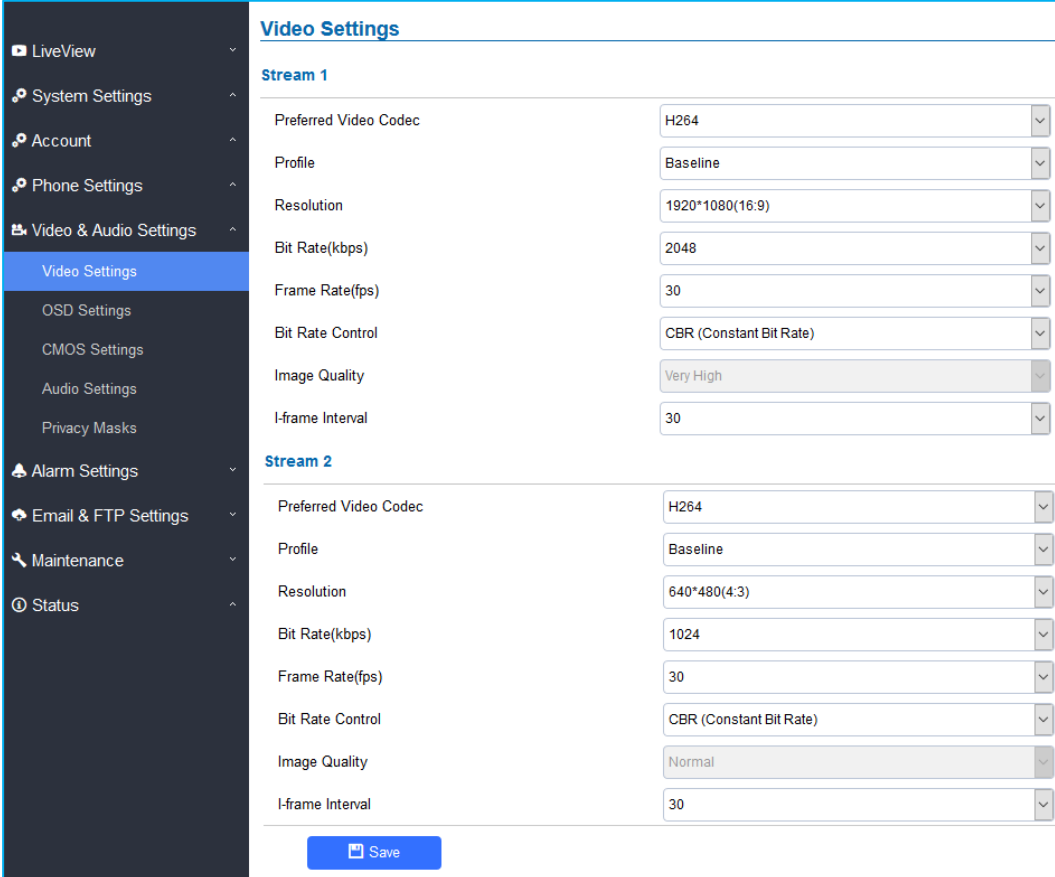

Video Settings

Stream 1

Preferred Video Codec	H264
Profile	Baseline
Resolution	1920*1080(16:9)
Bit Rate(kbps)	2048
Frame Rate(fps)	30
Bit Rate Control	CBR (Constant Bit Rate)
Image Quality	Very High
I-frame Interval	30

Stream 2

Preferred Video Codec	H264
Profile	Baseline
Resolution	640*480(4:3)
Bit Rate(kbps)	1024
Frame Rate(fps)	30
Bit Rate Control	CBR (Constant Bit Rate)
Image Quality	Normal
I-frame Interval	30

[Save](#)

Figure 23: Video Settings Page

Table 12: Video Settings

Stream 1	
Preferred Video Codec	Selects the videos codecs, the codecs supported are H.264, H.265 and MJPEG. Default setting is H.264.
Profile	Selects the H.264/H.265 profile. Three profiles are available for H.264: Baseline, Main Profile and High Profile. And one profile for H.265: HEVC Main
Resolution	Specifies the resolution in pixels used at video image.
Bit Rate(kbps)	Selects the video bit rate or bandwidth used.
Frame Rate(fps)	Selects the maximum frame rate used (more data if big frame used).
Bit Rate Control	Selects the constantly bit rate, or variable bit rate.
Image Quality	Selects the image quality used when Variable Bit Rate used.
I-frame Interval	Configures the I-frame interval (suggested 2~3 times of frame rate).
Stream 2	



Preferred Video Codec	Selects the videos codecs, the codecs supported are H.264, H.265 and MJPEG. Default setting is H.264.
Profile	Selects the H.264/H.265 profile. Three profiles are available for H.264: Baseline, Main Profile and High Profile. And one profile for H.265: HECV Main
Resolution	Specifies the resolution in pixels used at video image.
Bit Rate(kbps)	Selects the video bit rate or bandwidth used.
Frame Rate(fps)	Selects the maximum frame rate used (more data if big frame used).
Bit Rate Control	Selects the constantly bit rate, or variable bit rate.
Image Quality	Selects the image quality used when Variable Bit Rate used.
I-frame Interval	Configures the I-frame interval (suggested 2~3 times of frame rate).

Notes:

- H.264 suggested if the GSC3620 needs to be viewed via Internet.
- For definition of Baseline, Main Profile and High profile of H.264 please refer to: [H.264 Profiles](#)
- If MJPEG is selected, reduce the frame rate to the minimal value to save bandwidth and get better image.
- Grandstream GSC3620 provides two video streams, users can use them with flexibility. For example, the high-resolution stream for local recording, another low or high resolution for SIP video phone call or remote smartphone monitoring application, or vice versa depending on application scenarios.
- Use below link to calculate bandwidth and storage before installation <https://www.grandstream.com/support/tools/bandwidth-storage-calc>

OSD Settings

OSD Settings (On Screen Display) allow the users to Display time stamp and text on the video screen.

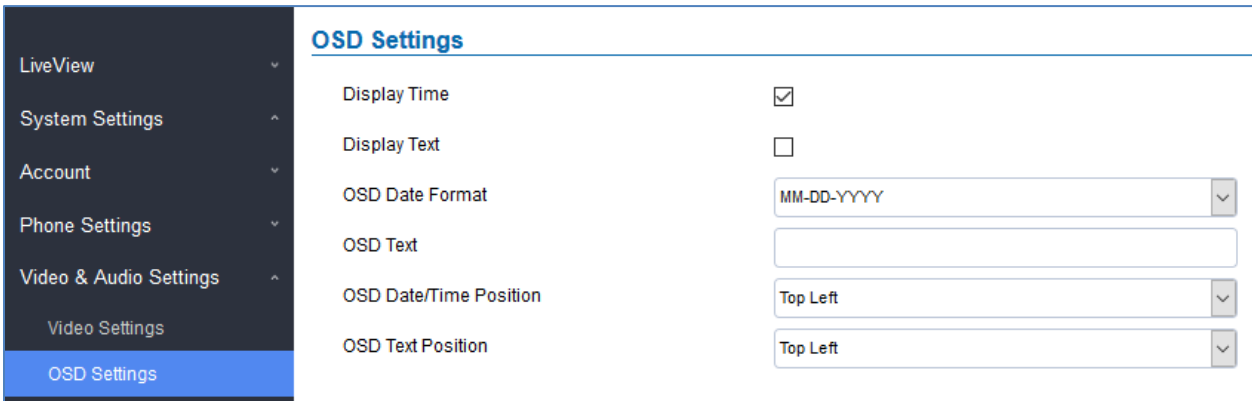

Figure 24: OSD Settings Page

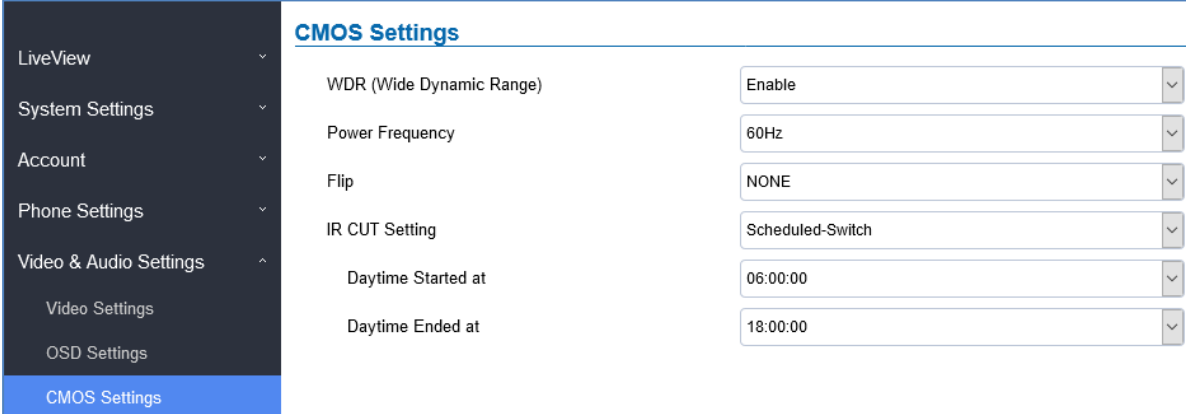

Table 13: OSD Settings

Display Time	When checked, time will be displayed inside the video image.
Display Text	When checked, inputted text on “OSD Test” will be displayed on the video image.
OSD Date Format	Select the date format from drop down list.
OSD Text	Input a text (to identify the GSC3620) it will be shown on the screen.
OSD Date/Time Position	Show the Date/Time position on the screen.
OSD Text Position	Show the text position on the screen.

CMOS Settings

This page configures the CMOS parameters for different scenarios.

Figure 25: CMOS Settings Page
Table 14: CMOS Settings

WDR (Wide Dynamic Range)	Enable or Disable the Wide Dynamic Range feature. Default “Enable”.
Power Frequency	Select correct light condition for the scene monitored: 50Hz power frequency (Europe, China, etc.) or 60Hz power frequency (US, Japan, etc.).
Flip	Pull down to choose to flip video either vertically, horizontal or both
IR CUT Setting	<p>Manual: User can set manually The Daytime/Night Model to either Daytime or Night.</p> <p>Automatic: The Camera will automatically switch to either Daytime or Night depending on light condition.</p> <p>Scheduled-Switch: The user can configure Daytime schedule by editing both "Daytime Started at" and "Daytime Ended at" fields. Default is Automatic.</p>



Audio Settings

This page allows users to configure the audio settings.

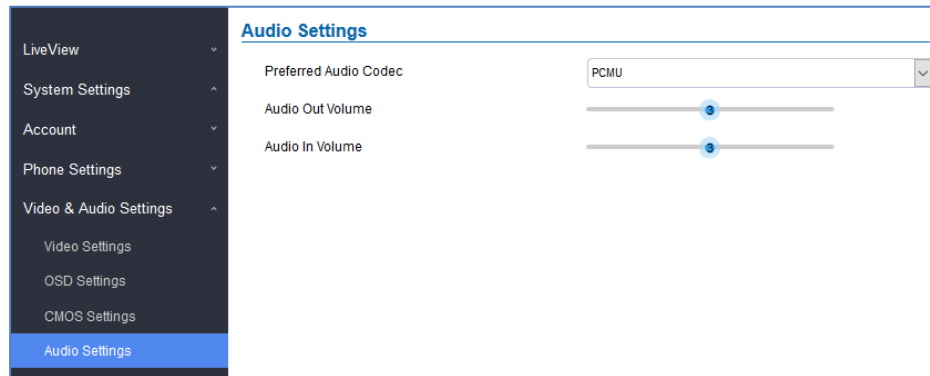

Figure 26: Audio Settings Page

Table 15: Audio Settings

Preferred Audio Codec	Configures the audio codec. Two codecs are available: PCMU and PCMA.
Audio Out Volume	Adjusts the speaker volume connected.
Audio In Volume	Adjusts the Mic volume.

Privacy Masks

This page allows users to configure privacy masks up to 4 different regions by selecting different regions requiring privacy mask as displayed on the following figure. When privacy mask enabled, the video at related region will be masked by black color and no video displayed inside that mask.

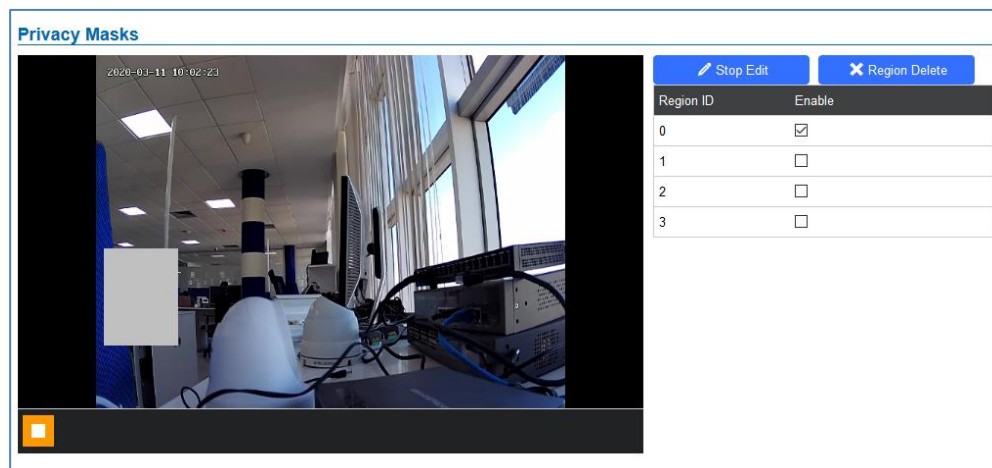

Figure 27: Privacy Masks Configuration Page

- Click **“Start Edit”** then long press and slide to identify a region
- Select a preconfigured region then Click **“Region Delete”** to remove it.



Alarm Settings

This page allows users to configure alarm schedule and alarm actions.

Alarm Events Config

This page allows users to configure GSC3620 events to trigger programmed actions within predefined schedule.

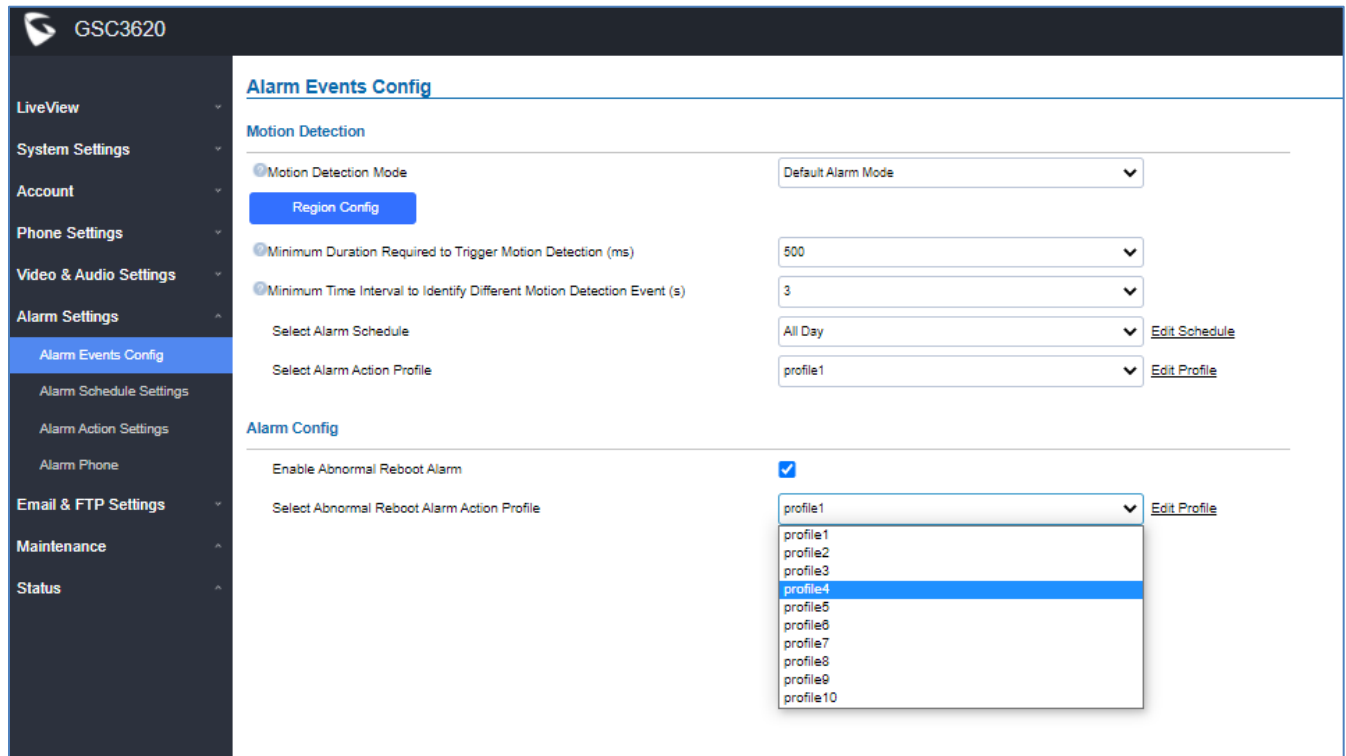

Figure 28: Alarm Events Config page

Table 16: Alarm Events Config Settings

Motion Detection Mode	<ul style="list-style-type: none"> • Default Alarm Mode: Single zone independent alarm • Sequence Alarm Mode: Set the sequence of multi-zone alarms. Alarm will trigger if matched the configured zone sequence, otherwise alarm will not trigger. • Multi-zone Combined Alarm Mode: Alarm will trigger when number of combined alarming zones reaches the configured amount, otherwise alarm will not trigger. • Zone Trigger Ratio Alarm Mode: Configure the ratio of single small squares compared to the whole alarm zone, alarm will trigger when the ratio reached.
-----------------------	---



Maximum Time to Identify a Valid Multi-Zone Alarm Detection	If all preset zones have triggered an alarm within the configured time (in Seconds), this will be considered as a valid alarm/event, otherwise it will be an invalid alarm.
Minimum Number of Alarming Zones for a Valid Multi-Zone Alarm Detection	If set multi-zone alarm, when the number of detection zones where alarm triggered reaches the configured number, it is considered a valid alarm/event, otherwise it will be an invalid alarm. For example, the value is set 3 with total of 4 zones, when zones with triggered alarm get to 3, a valid alarm/event will be reported.
Minimum Number of Blocks Per Region to Trigger Detection	The threshold is the ratio of single small squares compared to the whole alarm zone, alarm will trigger when the ratio reached.
Minimum Duration Required to Trigger Motion Detection (ms)	The time when an object moving in the preset zone is longer than the configured duration, this is considered a valid alarm/event, otherwise it is invalid alarm/event.
Minimum Time Interval to Identify Different Motion Detection Event (s)	This minimum time interval is used to identify different motion detection events. If two consecutive motion detection alarm events occurred within this time interval, they will be considered as the same motion event. Otherwise they will be considered as two different motion events.

Motion Detection

Users can select a specific region to trigger the alarm using motion detection.

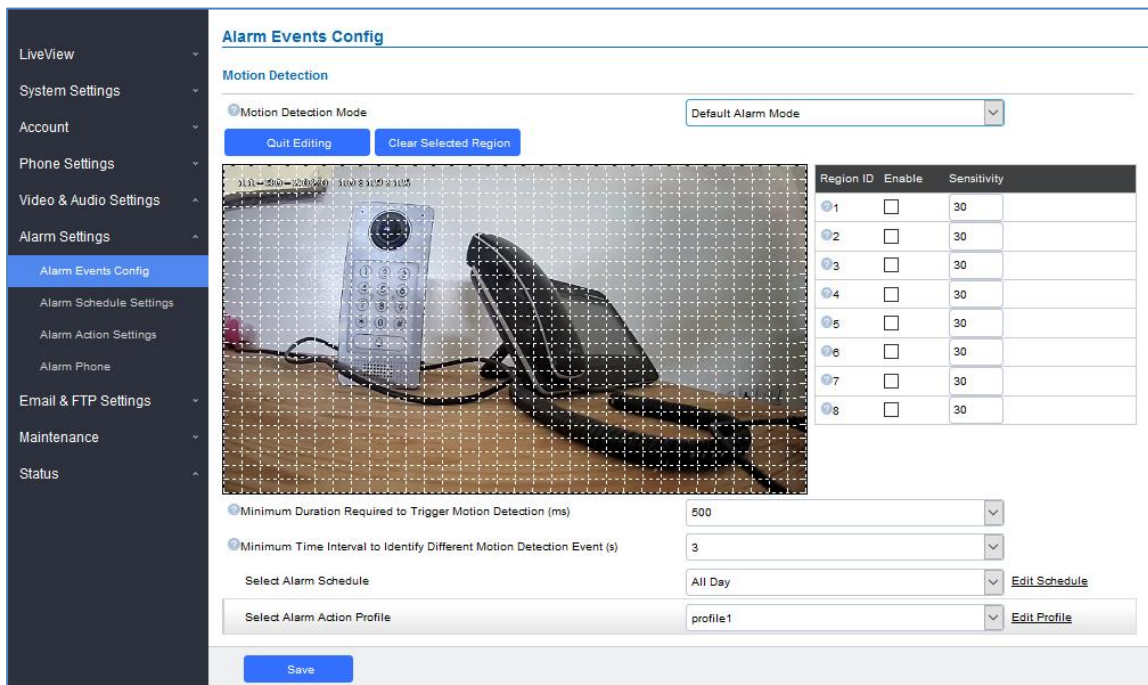

Alarm Events Config

Motion Detection

Motion Detection Mode: Default Alarm Mode

[Quit Editing](#) [Clear Selected Region](#)

Region ID	Enable	Sensitivity
1	<input type="checkbox"/>	30
2	<input type="checkbox"/>	30
3	<input type="checkbox"/>	30
4	<input type="checkbox"/>	30
5	<input type="checkbox"/>	30
6	<input type="checkbox"/>	30
7	<input type="checkbox"/>	30
8	<input type="checkbox"/>	30

Minimum Duration Required to Trigger Motion Detection (ms):

Minimum Time Interval to Identify Different Motion Detection Event (s):

Select Alarm Schedule: All Day [Edit Schedule](#)

Select Alarm Action Profile: profile1 [Edit Profile](#)

[Save](#)

Figure 29: Region Config



Table 17: Motion Detection

Region Config	Configures the motion detection region. First click to access the Region Config menu and second click to quit.
Clear Selected Region	Selects a zone on the screen then click on “Clear” to delete the region.
Sensitivity	Specifies the region sensitivity (value between 0-100%).
Select Alarm Schedule	Selects the alarm schedule.
Select Alarm Action Profile	Selects the programmed Alarm Action profile.

Alarm Config

This page specifies the configuration of Abnormal Reboot Alarm Action.

Enable Abnormal Reboot Alarm	When checked, the IPC will sent an email if there is a power outage, which could affect the Auto-Focus as the AF might be affected after this power failure causing all the later on recording to become unclear. Thus the email will help the administrator to login and take corrective actions.
Select Abnormal Reboot Alarm Action Profile	If all preset zones have triggered an alarm within the configured time (in Seconds), this will be considered as a valid alarm/event, otherwise it will be an invalid alarm.

Alarm Schedule Settings

This page specifies the configuration of Alarm Schedule.

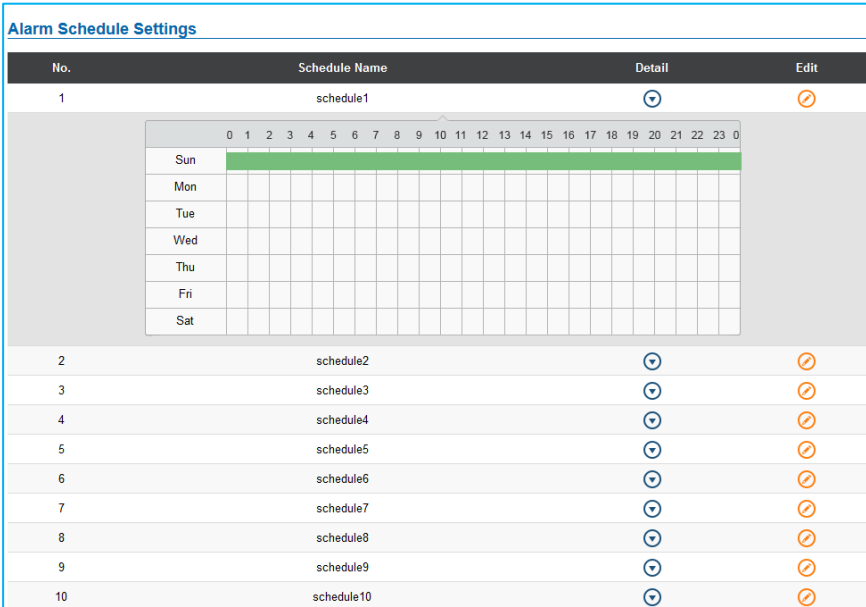

Note: Schedule must be configured first to allow the alarm to take the related action.



The screenshot shows the 'Alarm Schedule Settings' interface. It features a table with columns for 'No.', 'Schedule Name', 'Detail', and 'Edit'. The first row shows '1' for 'schedule1'. Below this, a calendar grid is displayed for 'schedule1', with the days of the week (Sun-Sat) and hours (0-23) on the axes. The 'Sun' row is highlighted in green, indicating a 24-hour schedule. Below the calendar, there are 10 rows of schedule entries, each with a dropdown arrow in the 'Detail' column and an edit icon in the 'Edit' column.

No.	Schedule Name	Detail	Edit
1	schedule1	⌵	✎
2	schedule2	⌵	✎
3	schedule3	⌵	✎
4	schedule4	⌵	✎
5	schedule5	⌵	✎
6	schedule6	⌵	✎
7	schedule7	⌵	✎
8	schedule8	⌵	✎
9	schedule9	⌵	✎
10	schedule10	⌵	✎

Figure 30: Alarm Schedule

GSC3620 supports up to 10 alarm schedules to be configured, with time span specified by users. Users can View the schedule details by clicking  or Edit the alarm schedule by clicking  button.

Usually the 24 hours' span is 00:00 ~ 23:59, which is 24 hours' format. Note that it is possible to copy the configuration to different date during the schedule programming using the banner at the bottom.

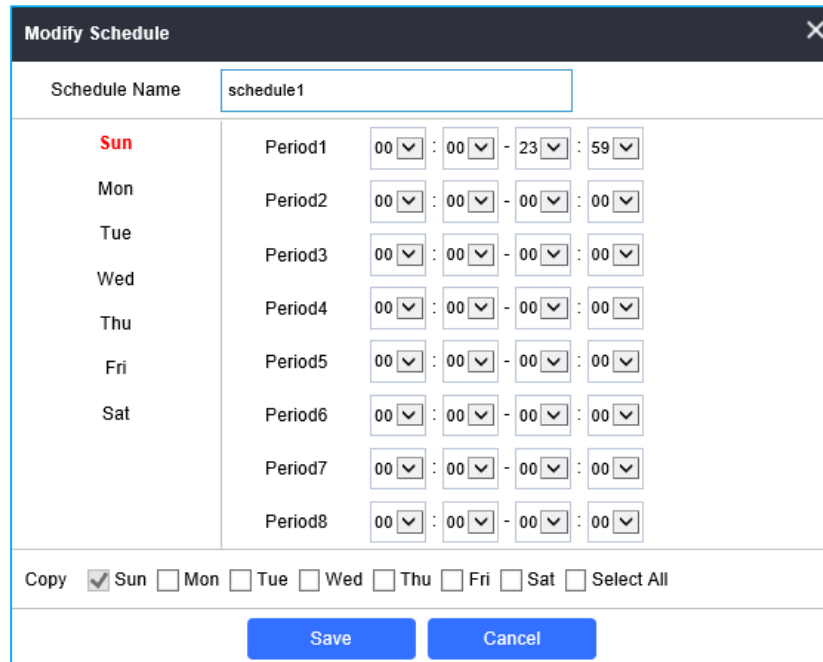

Day	Period	Time 1	Time 2	Time 3	Time 4
Sun	Period1	00	00	23	59
Mon	Period2	00	00	00	00
Tue	Period3	00	00	00	00
Wed	Period4	00	00	00	00
Thu	Period5	00	00	00	00
Fri	Period6	00	00	00	00
Sat	Period7	00	00	00	00
	Period8	00	00	00	00

Copy Sun Mon Tue Wed Thu Fri Sat Select All

Save Cancel

Figure 31: Edit Schedule

Alarm Action Settings

This page specifies the configuration of Profile used by the Alarm Actions. A Profile is required before the Alarm Action can take effect.

No.	Alarm Action Profile Name	Detail	Edit
1	profile1	<div style="border: 1px solid gray; padding: 5px;"> <div style="display: flex; justify-content: space-between;"> <div style="width: 45%;"> <p><input checked="" type="checkbox"/> Upload to Alarm Center</p> <p><input checked="" type="checkbox"/> Send Email</p> </div> <div style="width: 45%;"> <p><input checked="" type="checkbox"/> Audio Alarm to SIP Phone</p> <p><input checked="" type="checkbox"/> Upload Snapshot</p> </div> </div> </div>	
2	profile2		
3	profile3		
4	profile4		
5	profile5		
6	profile6		
7	profile7		
8	profile8		
9	profile9		
10	profile10		

Figure 32: Alarm Action

User can edit the alarm action by clicking  button, the following window will popup.

Modify Alarm Action Profile ✕

Alarm Action Profile Name

Upload to Alarm Center

Send Email

Audio Alarm to SIP Phone

Upload Snapshot

Save Cancel

Figure 33: Edit Alarm Action

Table 18: Alarm Actions

Upload to Alarm Center	If selected, the GSurf will popup alarm window and sound alarm in the computer speaker.
Audio Alarm to SIP Phone	If selected, GSC3620 will call pre-configured (video or audio) phone and will play sound alarm.
Send Email	If selected, an email with snapshot will be sent to the pre-configured email destination.
Upload Snapshot	If selected, snapshots at the moment where the event is triggered will be sent to preconfigured destination (e.g.: FTP or email).



Alarm Phone List

This page allows users to configure the Alarm Phone List, which are phone numbers or extensions list that the GSC3620 will call out when event is triggered.

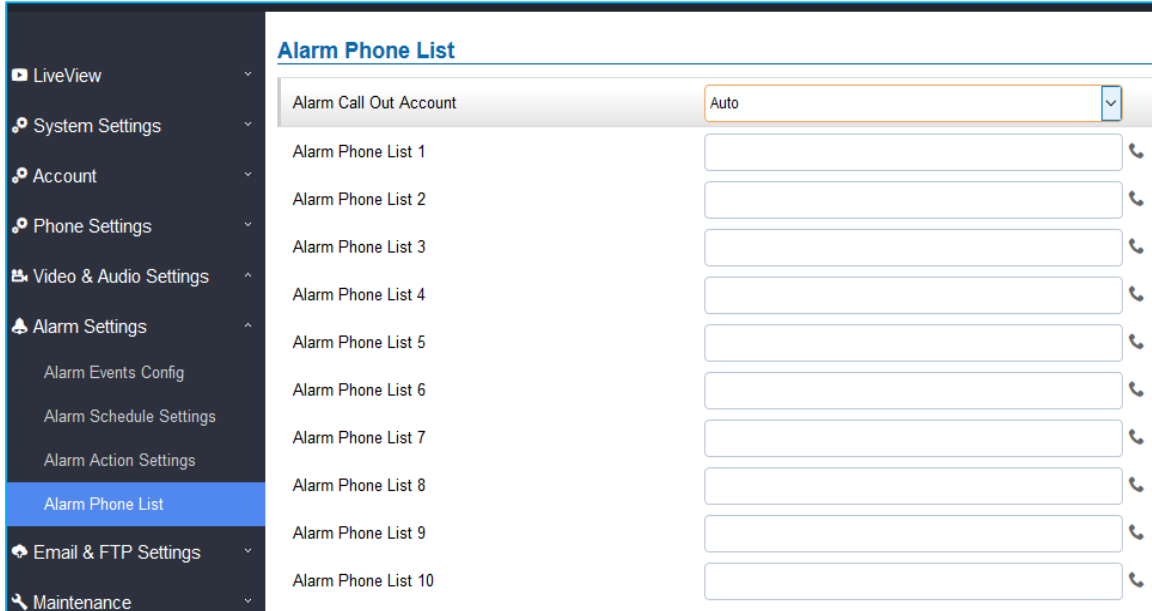

Figure 34: Alarm Phone List

Table 19: Alarm Phone List

Alarm Call Out Account	Select the SIP Account to be used by the GSC3620 when alarm out is triggered.
Alarm Phone List 1-10	Add or delete number from the phone alarm list. (When IP address is used then the port needs to be appended, example: 192.168.1.12:5060).

Once the event is triggered the GSC3620 will call the first number, once time out is reached and no answer is returned from the first number, the GSC3620 will try the next number on the list and so on. Once the remote phone answers the call, an alarm will be played to notify users that an event is triggered.

Email & FTP Settings

This page contains Email and FTP Settings.

Email Settings

This page allows users to configure email client to send out an email when the alarm is triggered.



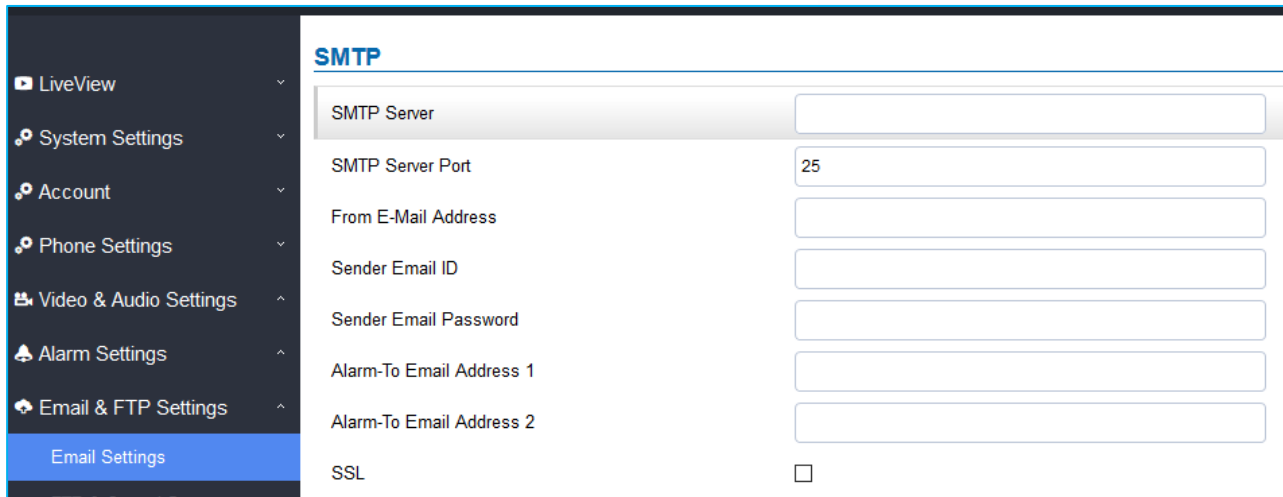

Figure 35: Email Settings - SMTP Page

Table 20: Email Settings - SMTP

SMTP Server	Configures the SMTP Email Server IP or Domain Name.
SMTP Server Port	Specifies the Port number used by server to send email.
From E-mail address	Specifies email address of alarm email sending from, usually client email ID.
Sender Email ID	Specifies sender's User ID or account ID in the email system used.
Sender Email Password	Specifies sender's password of the email account.
Alarm-To Email Address 1	Specifies the 1 st email address to receive the alarm email.
Alarm-To Email Address 2	Specifies the 2 nd email address to receive the alarm email.
SSL	Check if the SMTP email server requires SSL.

Notes:

- Click “Save” to save the email configuration information.
- Click “Email Test” after configuration, if settings are correct, a test email will send out and “E-mail test successfully” message on the top page will appear.

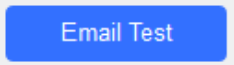

FTP & Center Storage

This page allows users to configure the FTP Settings in order to upload capture images.

Table 21: Picture Storage Settings

FTP Server	Configures the IP address of the FTP server when selected to upload images to.
FTP Server Port	Specifies the FTP address port.
FTP Username	Specifies the FTP server account name.
FTP Password	Specifies the FTP server password.
FTP Path	Specifies the storage path.
FTP Test	Click to test the connection with FTP server.

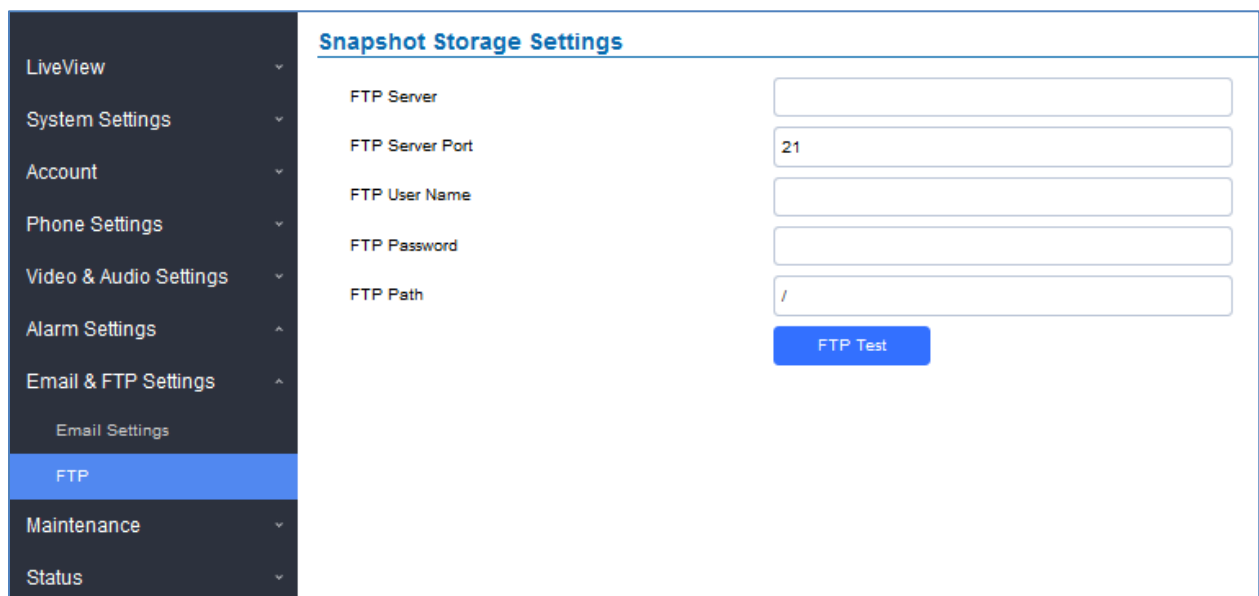
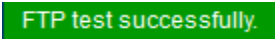

Figure 36: Picture Storage Settings

Notes:

- If the connection to the FTP server is successful, a “.txt” file containing a success message will be uploaded to the FTP server. And the following message will pop up on the Web GUI

- Central Storage will store screenshots locally.

Maintenance Settings

This page shows the GSC3620 Maintenance parameters.

Upgrade

This page contains the upgrade and provisioning parameters of the GSC3620.



- LiveView
- System Settings
- Account
- Phone Settings
- Video & Audio Settings
- Alarm Settings
- Email & FTP Settings
- Maintenance
- Upgrade
- Reboot & Reset
- Debug Log
- Data Maintenance
- Event Notification
- Certificates
- Status

Upgrade

Firmware

Upgrade Via	<input type="text" value="HTTP"/>
Firmware Server Path	<input type="text" value="fm.grandstream.com/gs"/>
HTTP/HTTPS User Name	<input type="text"/>
HTTP/HTTPS Password	<input type="text"/>
Firmware File Prefix	<input type="text"/>
Firmware File Postfix	<input type="text"/>

Config

Upgrade Via	<input type="text" value="HTTPS"/>
Config Server Path	<input type="text" value="fm.grandstream.com/gs"/>
HTTP/HTTPS User Name	<input type="text"/>
HTTP/HTTPS Password	<input type="text"/>
Config File Prefix	<input type="text"/>
Config File Postfix	<input type="text"/>
XML Config File Password	<input type="text"/>

Validate Server Certificates	<input type="checkbox"/>
Enable DHCP Option 66 Override Server	<input checked="" type="checkbox"/>
Zero Config	<input checked="" type="checkbox"/>
Enable DHCP Option 120 Override SIP Server	<input type="checkbox"/>
Automatic Upgrade	<input type="radio"/> No <input checked="" type="radio"/> Yes, check for every <input type="text" value="10080"/> minute(s) <input type="radio"/> Yes, check for every day <input type="radio"/> Yes, check for every week
Randomized Automatic Upgrade	<input type="checkbox"/>
Hour of the Day (0-23)	Start <input type="text" value="1"/> End <input type="text" value="23"/>
Day of the Week (0-6)	<input type="text" value="1"/>

Figure 37: Upgrade Page



Table 22: Upgrade

Firmware	
Upgrade Via	Selects the upgrade method (TFTP, HTTP, or HTTPS).
Firmware Server Path	Configures the IP address or the FQDN of the upgrade server.
HTTP/HTTPS Username	The username for the HTTP/HTTPS server.
HTTP/HTTPS Password	The password for the HTTP/HTTPS server.
Firmware File Prefix	Enables your ITSP to lock configuration updates. If configured, only the firmware file with the matching encrypted prefix will be downloaded and flashed into the phone.
Firmware File Postfix	Enables your ITSP to lock firmware updates. If configured, only the firmware with the matching encrypted postfix will be downloaded and flashed into the phone.
Config	
Upgrade via	Selects the upgrade method (TFTP, HTTP, and HTTPS).
Config Server Path	Configures the IP address or the FQDN of the configuration server.
HTTP/HTTPS Username	The username for the HTTP/HTTPS server.
HTTP/HTTPS Password	The password for the HTTP/HTTPS server.
Config File Prefix	Enables your ITSP to lock configuration updates. If configured, only the configuration file with the matching encrypted prefix will be downloaded and flashed into the phone.
Config File Postfix	Enables your ITSP to lock configuration updates. If configured, only the configuration file with the matching encrypted postfix will be downloaded and flashed into the phone.
XML Config File Password	Specifies the password for the configuration file.
Validate Server Certificate	Enable this option in order to validate certificate with trusted ones during TLS connection.
Enable DHCP Option 66 Override Server	Activates DHCP option 66 to override upgrade/config servers.



Zero Config	Enables Zero Config feature for auto provisioning.
Enable DHCP Option 120 Override SIP Server	Enables DHCP Option 120 from local server to override the SIP Server on the phone. The default setting is enabled.
Automatic Upgrade	Enables automatic upgrade and provisioning. Set schedule for provisioning for either every X minute, every day, or every week. Default is No.
Randomized Automatic Upgrade	Enable and define the start/End hours of the day and days of the week where the GSC3620 will randomly checking for update.

Reboot & Reset

This page allows user to reboot and reset the GSC3620.

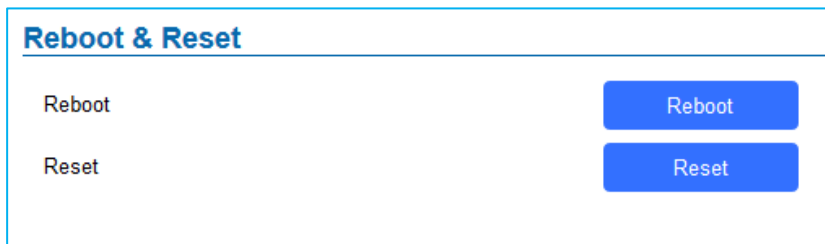

Figure 38: Reset & Reboot Page

Table 23: Reset & Reboot

Reboot	When clicked, the GSC3620 will restart (soft reboot).
Reset	Restore Factory Default Settings

Debug Log

This page allows user to configure SYSLOG to collect information to help troubleshooting issues with GSC3620.

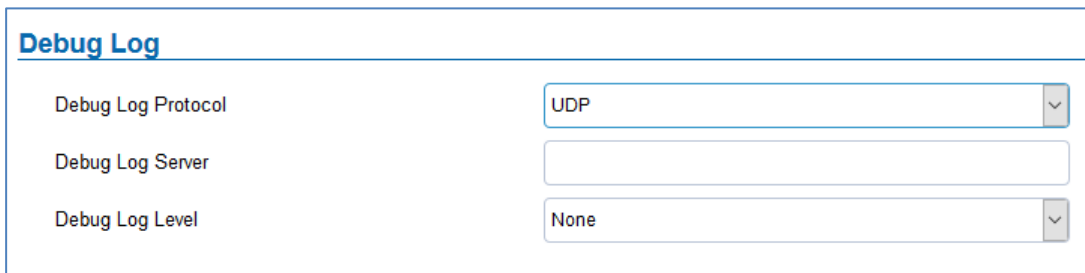

Figure 39: Debug Log Page

- Users can choose to set Debug Log Protocol to **UDP** or **SSL/TLS**.
- Five levels of Debugging are available, **None**, **Debug**, **Info**, **Warning**, **Error**.



- Once the Syslog Server and the level entered, press “**Save**” and then Reboot the device to apply the settings.

Data Maintenance

This page allows users to manage the GSC3620 configuration file by importing/exporting configuration files.

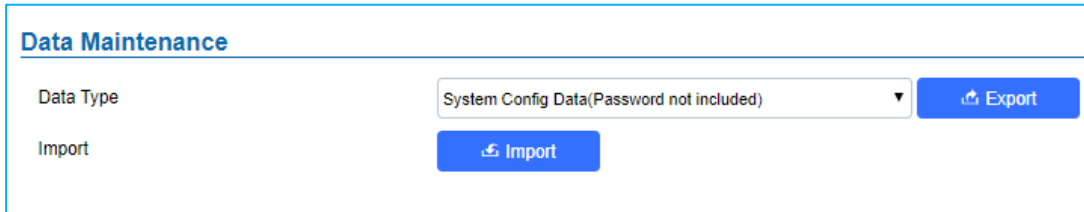
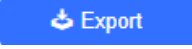

Figure 40: Data Maintenance Page

Notes:

- Click on  to save the GSC3620 configuration in a predefined directory.
- Users can either select to include all the passwords (SIP, FTP, Remotes access...) on the configuration files exported or not including the passwords as displayed on the previous figure.

Event Notification

This page allows users to configure the event notification details that will be used by GSC3620 to communicate to an HTTP server to log the events. When the feature is enabled and configured, all the event logs will be uploaded to server:

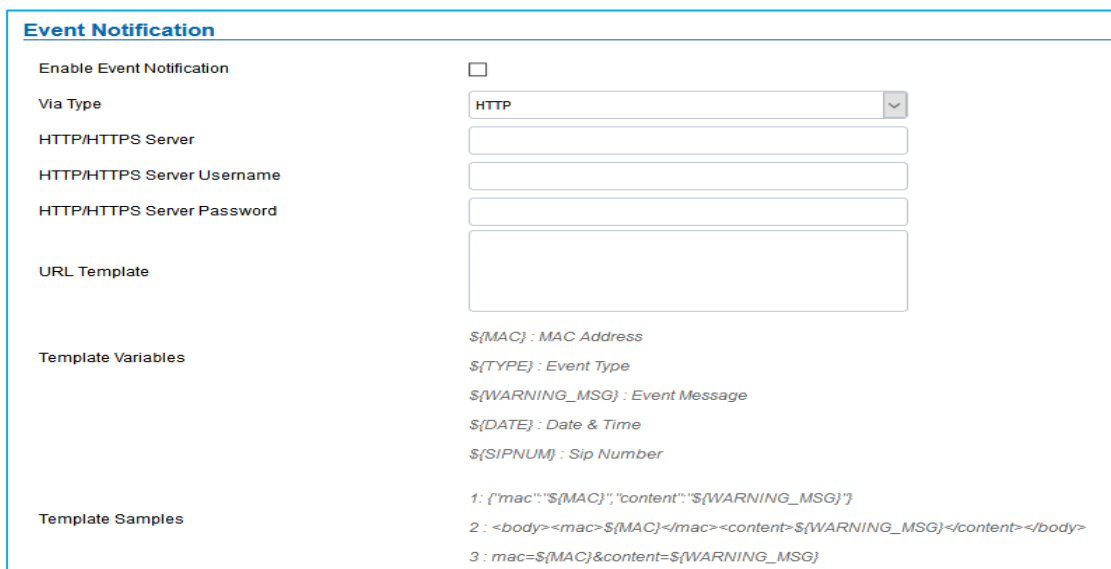

Figure 41: Log Manager Page



Table 24 : Log Manager Settings

Enable Event Notification	Enables Event Notification feature
Via Type	Choose which protocol will be used to connect to the logs server (HTTP or HTTPS).
HTTP/HTTPS Server	Enter the IP address of domain name for the logs server.
HTTP Server Username	Configure the username of your HTTP(s) server
HTTP Server Password	Configure the password of your HTTP(s) server
URL Template	<p>Specify the template for the event log messages that will be sent to the server, users can use the following variables to customize the message:</p> <ul style="list-style-type: none"> • \${MAC}: MAC Address • \${TYPE}: Event Type • \${WARNING_MSG}: Event Message • \${DATE}: Date & Time • \${SIPNUM}: SIP Number

- User can test the configuration by clicking on  button at the bottom

Certificates

This page allows users to upload up to 6 Trusted CA certificate files which will be trusted by the GSC3620 during SSL exchange. Also, users are allowed to configure the device with custom certificate signed by custom CA certificate under the Custom Certificate section.















Certificates			
Trusted CA Certificates			
No.	Issued By	Expiration	
1			 Upload  Delete
2			 Upload  Delete
3			 Upload  Delete
4			 Upload  Delete
5			 Upload  Delete
6			 Upload  Delete
Custom Certificate			
No.	Issued By	Expiration	
1			 Upload  Delete

Figure 42: Upload Certificate files

In order to upload your Trusted CA certificate, you may proceed as follows:

- Click on  button to upload a file and some related information to the uploaded file will be displayed, such as “**Issued by**” and “**Expiration date**”.



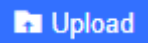



Trusted CA Certificates			
No.	Issued By	Expiration	
1	-	2018-07-17 15:46:03	 
2			 

Figure 43: Trusted CA Certificates

- Users could press  to delete one of the files.

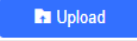
In order to upload your Custom certificate, you may proceed as follows:

- Click on  button to upload a file and some related information to the uploaded file will be displayed, such as “**Issued by**” and “**Expiration date**”.



Custom Certificate			
No.	Issued By	Expiration	
1			 

Figure 44: Custom certificate



Status

This page displays GSC3620 system and network information.

Account Status

This page displays of configured accounts’ SIP user ID, SIP server as well as the SIP Registration status, from Account 1 to Account 4.

Notes:

- When the SIP account is registered, the SIP Registration status display will be .
- When SIP account is unregistered, the SIP Registration status display will be .



Account Status			
Account	SIP User ID	SIP Server	SIP Registration Status
Account 1			Offline
Account 2			Offline
Account 3			Offline
Account 4			Offline

Figure 45: Account Status Page

System Info

This page displays information such as the product model, the hardware version, firmware...

System Info	
Product Model	GSC3620
Hardware Version	V1.0A
Part Number	9670007410A
Serial Number	21JD61GL902EE82B
Boot Version	1.0.5.3
Core Version	1.0.5.3
Base Version	1.0.5.3
Prog Version	1.0.5.3
System Uptime	6 minutes
Firmware Status	<div style="border: 1px solid gray; padding: 2px; display: inline-block;">Press check button and reload page to check firmware availability.</div> <input type="button" value="Check"/>

Figure 46: System Info Page

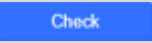

Table 25: System Info

Product Model	Displays the Product Model.
Hardware Version	Displays the Hardware Version.
Part Number	Displays the Part Number.
Boot Version	Displays the Boot Version.
Core Version	Displays the Core Version.
Base Version	Displays the Base Version.
Prog Version	Displays the Prog Version.
System Up Time	Displays the time since the first boot of the GSC3620.
Firmware Status	Click the  button to check whether the firmware in the firmware server has an updated version, if so, update immediately.

Network Info

This page displays the network system information of GSC3620.

Network Info	
MAC Address	C0:74:AD:16:2F:53
IP Address Mode	DHCP
IP Address	192.168.0.160
Subnet Mask	255.255.0.0
Gateway	0.0.0.0
DNS Server 1	0.0.0.0
DNS Server 2	0.0.0.0

Figure 47: Network Info Page
Table 26: Network Info

MAC Address	Displays the GSC MAC Address.
IP Address Mode	Displays the IP address mode used.
IP Address	Displays the IP address of the GSC3620.
Subnet Mask	Displays the Subnet Mask used.
Gateway	Displays the GSC3620 Gateway.
DNS Server 1	Displays the Preferred DNS Server.
DNS Server 2	Displays the secondary DNS Server.



EXPERIENCING THE GSC3620

Please visit our website: <https://www.grandstream.com> to receive the most up- to-date updates on firmware releases, additional features, FAQs, documentation and news on new products.

We encourage you to browse our [product related documentation](#), [FAQs](#) and [User and Developer Forum](#) for answers to your general questions. If you have purchased our products through a Grandstream Certified Partner or Reseller, please contact them directly for immediate support.

Our technical support staff is trained and ready to answer all of your questions. Contact a technical support member or [submit a trouble ticket online](#) to receive in-depth support.

