



2N[®] Helios IP Force

Door Access Intercom



Installation Manual

Version

1.0.0

www.2n.cz

The 2N TELEKOMUNIKACE a.s. joint-stock company is a Czech manufacturer and supplier of telecommunications equipment.



The product family developed by 2N TELEKOMUNIKACE a.s. includes intercoms, GSM and UMTS products, private branch exchanges (PBXs) and M2M solution.

2N TELEKOMUNIKACE a.s. has been ranked among the Czech top companies for years and represents a symbol of prosperity in the field of IP intercoms. Furthermore, the company dedicates significant attention to operator solutions as well as to effectively providing support for our distribution network and customer service. At present, we export our products into over 120 countries worldwide and have exclusive distributors on all continents.



2N® is a registered trademark of 2N TELEKOMUNIKACE a.s.. Any product and/or other names mentioned herein are registered trademarks and/or trademarks or brands protected by law.



2N TELEKOMUNIKACE administers the FAQ database to help you quickly find information and to answer your questions about 2N products and services. On faq.2n.cz you can find information regarding products adjustment and instructions for optimum use and procedures „What to do if...“.



Declaration of Conformity

2N TELEKOMUNIKACE a.s. hereby declares that the 2N® Helios IP Force product complies with all basic requirements and other relevant provisions of the 1999/5/EC directive. For the full wording of the Declaration of Conformity see the CD-ROM enclosed and at www.2n.cz.



2N TELEKOMUNIKACE company is the owner of the ISO 9001:2008 certificate. All development, production and distribution processes of the company are managed by this standard and guarantee high quality, technical level and professional aspect of all our products.

Contents

1. Product Overview.....	1
1.1 Product Description	2
Basic Features.....	2
Advantages of Use	3
1.2 Upgrade	4
1.3 2N® Helios IP Force Components and Associated Products.....	5
Basic Units.....	5
Flush Mounting Box.....	6
GSM / UMTS Connection Accessories	6
VoIP Connection Accessories	7
Electric Locks	7
Other Accesories	7
1.4 Terms and Symbols	8
Symbols.....	8
2. Description and Installation	9
2.1 Before You Start	10
Product Completeness Check.....	10
2.2 Mechanical Installation	11
Mounting Type Overview.....	11
Common Mounting Principles	13
Flush Mounting – Classic Bricks	14
Flush Mounting – Thermally Insulated Wall	15
Flush Mounting – Hollow Bricks	16
Flush Mounting – Plasterboard	16
Wall Mounting.....	17
Use of Cable Bushings.....	18
2.3 Electric Installation	19
PCB Connectors.....	19
Configuration Jumpers	21
Mounting Completion	22
2.4 Button Tags – Insertion and Replacement	23
Tag Printing	23
Tag Inserting / Replacing Instructions	23

- 3. Function and Use25**
 - 3.1 2N[®] Helios IP Force Configuration 26**
 - 3.2 2N[®] Helios IP Force Control 28**
 - Speed Dial Buttons..... 28
 - Calling to Telephone Directory Positions 28
 - Calling to Telephone Number..... 28
 - Answering and Rejecting Incoming Calls 28
 - Door Opening (Switch Activation) by Code 29
 - User / Profile Activation and Deactivation 29
 - 3.3 Maintenance..... 30**
 - Cleaning 30
 - Future Tag Replacement, Programming Changes 30

- 4. Technical Parameters31**
 - 4.1 Technical Parameters 32**

- 5. Supplementary Information35**
 - 5.1 Directives, Laws and Regulations 36**
 - 5.2 Troubleshooting 37**
 - 5.3 General Instructions and Cautions 38**
 - Electric Waste and Used Battery Pack Handling 39

1

Product Overview

In this section, we introduce the **2N[®] Helios IP Force** product, outline its application options and highlight the advantages following from its use.

Here is what you can find in this section:

- Product Description
- Upgrade
- 2N[®] Helios IP Force Components and Associated Products
- Terms and Symbols

1.1 Product Description

Basic Features

2N® Helios IP Force is a highly resistant and reliable IP door access intercom provided with a lot of useful above-standard functions. Supporting the SIP standard and being compatible with the leading IP PBX and telephone suppliers, 2N® Helios IP Force can make use of all VoIP services. 2N® Helios IP Force can work as a standard or emergency door access intercom for buildings, entrances to premises or garages, manufacturing halls, highways and so on.

2N® Helios IP Force is equipped with two very sensitive microphones and an up to 10W loudspeaker. Thanks to an integrated acoustic echo cancelling (AEC) system, the product provides mutual audibility even of persons talking at the same time under normal conditions.

2N® Helios IP Force can be equipped with a colour wide-angle camera, which displays the calling person on the called party's video telephone or PC monitor.

2N® Helios IP Force can be provided with 1, 2 or 4 pre-programmed buttons. You can set up to three telephone numbers and time profiles for each of the buttons to increase the accessibility of the called party.

2N® Helios IP Force can be equipped with a numerical keypad to be used as a code lock for lock switch activating or telephone/subscriber number dialling.

2N® Helios IP Force is equipped with an electric lock switch. You can control the switch using a numerical keypad or, during a call, using any telephone set. An additional switch module can be installed if necessary. A wide range of settings allow for a variety of applications.

2N® Helios IP Force can also be provided with RFID card reader modules.

2N® Helios IP Force is very easy to install. All you have to do is connect the system into your LAN via a network cable and feed it from a 12V power supply or your PoE supporting LAN.

Configure **2N® Helios IP Force** using your PC via any web browser. Use the **2N® Helios IP Manager** to manage extensive 2N® Helios IP Force systems easily and quickly.

Advantages of Use

- Uncompromising AntiVandal design
- High covering level – up to class IP69
- Variable mounting options (brick/plasterboard flush mounting, surface mounting)
- Sensitive microphone and powerful loudspeaker
- Bidirectional communication – acoustic echo cancelling
- Integrated colour camera with wide-angle lens
- Optional dial buttons including name tags and backlight
- Optional numerical keypad with backlight
- Integrated electronic lock switches with wide setting options
- Optional integrated RFID card reader module
- LAN (PoE) or external 12V power supply
- Configuration via web interface or dedicated PC application
- SIP 2.0 support
- Up to 999 telephone directory positions
- Up to 20 user time profiles
- Video codecs (H.263+, H.264, MPEG-4, JPEG)
- Audio codecs (G.711, G.729)
- HTTP server for configuration
- SNTP client for time synchronisation with server
- RTSP server for video streaming
- SMTP client for e-mail sending
- TFTP client for automatic configuration and firmware update

1.2 Upgrade

The manufacturer reserves the right to modify the product in order to improve its qualities.

Version	Changes

1.3 2N® Helios IP Force Components and Associated Products

Basic Units



9151101

1 button



9151101C

1 button with camera



9151101W

1 button, 10W loudspeaker, IP69



9151101CW

1 button with camera, 10W loudspeaker, IP69



9151104

4 buttons



9151104C

4 buttons with camera



9151101K

1 button with keypad



9151101CK

1 button with keypad and camera

2N® Helios IP Force is designed for outdoor applications and requires no additional roof. W-including Part Nos. are intended for WAP pressure cleaning and extremely noisy environments (such as highways, etc.).

All 2N® Helios IP Force units can be flush or wall mounted without requiring any additional accessories. Use the appropriate mounting box (see below) for plasterboard and hollow brick flush mounting.

Flush Mounting Box

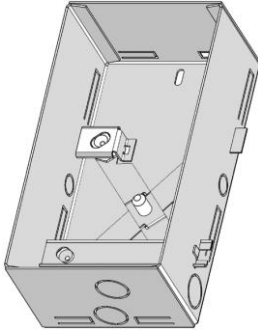

9151001

Brick flush mounting box

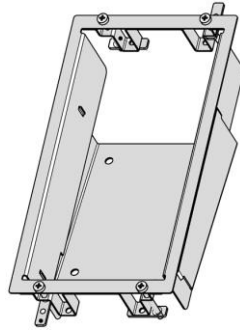

9151002

Plasterboard flush mounting box

GSM / UMTS Connection Accessories



505004

2N® VoiceBlue Lite



505214

2N® VoiceBlue Enterprise



505612

2N® UMTS Office Route

VoIP Connection Accessories



91378100
PoE injector



91378300
Grandstream VoIP telephone



91378350
Grandstream VoIP video telephone

Electric Locks



932070
BEFO 1211 12V / 600 mA



932080
BEFO 1221
with momentary pin



932090
BEFO 1211MB
with mechanical blocking

Other Accessories



91341481E
12 V/2 A adapter



932928E
12 V transformer



9137410E
External IP relay

A stabilised power supply must be used where PoE supply is not applied.

1.4 Terms and Symbols

Symbols



Safety Warning

- **Always** abide by this information to prevent injury of persons!



Warning

- **Always** abide by this information to prevent damage to the device.



Caution

- **Important information** for system functionality.



Tip

- Useful advice.



Note

- Additional information.

2

Description and Installation

In this section we describe the **2N[®] Helios IP Force** product and its installation.

Here is what you can find in this section:

- Before You Start
- Mechanical Installation
- Button Tags – Insertion and Replacement
- Electric Installation

2.1 Before You Start

Product Completeness Check

Please check the contents of your 2N[®] Helios IP Force delivery:

- 1 2N[®] Helios IP Force (selected model)
- 1 frame (of the corresponding colour)
- 1 Torx 10 / Torx 20 double-ended wrench
- Bushings (enclosed):
 - 1 big two-hole sealed bushing with nut
 - 1 spare sealing for big bushing for a thick cable, one hole
 - 1 big blank with nut
 - 1 small bushing with nut
 - 1 bushing plug, big size
 - 2 bushing plugs, small size
- 1 2N[®] Helios IP Force Installation Manual
- 1 mounting template
- 1 CD
- 1 A5 transparent name plate foil
- 1 spare name tag
- 4 5x90 mm screws
- 4 "intelligent" 8x50 mm dowels

2.2 Mechanical Installation

Mounting Type Overview

Refer to the table below for a list of mounting types and necessary components.

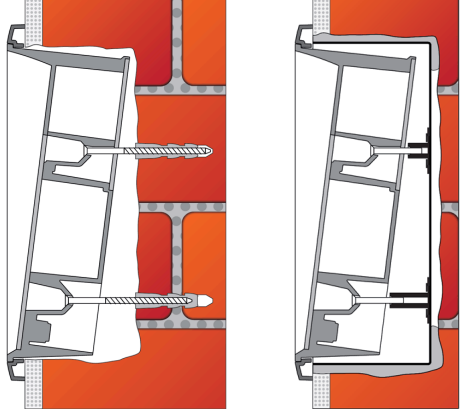
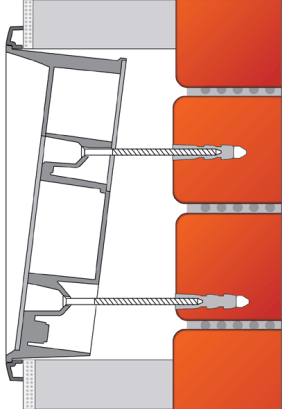
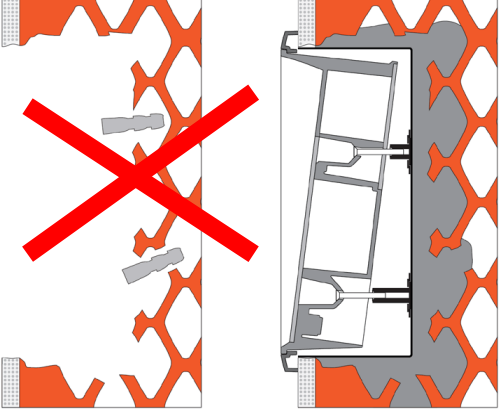
<p>Flush mounting – classic bricks</p> <p>What You Need:</p> <p>A precisely cut hole or, optionally, the brick flush mounting box, Part No. 9151001</p>	
<p>Flush mounting – thermally insulated wall</p> <p>What You Need:</p> <p>Longer screws (depending on the thermal insulation thickness)</p>	
<p>Flush mounting – hollow bricks</p> <p>What You Need:</p> <p>Brick flush mounting box, Part No. 9151001</p>	

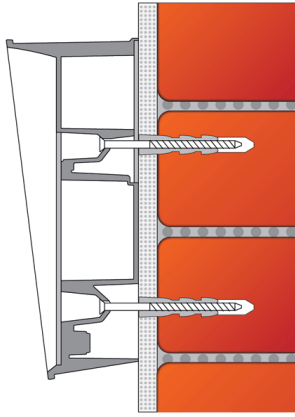
<p>Flush mounting – plasterboard wall</p> <p>What You Need:</p> <p>Plasterboard flush mounting box, Part No. 9151002</p>	
<p>Wall mounting (concrete and steel structures, entry barrier columns, etc.)</p> <p>What You Need:</p> <p>Just your 2N® Helios IP Force unit (the covering frame is not applied)</p>	



Caution

- The warranty does not apply to the product defects and failures arisen as a result of improper mounting (in contradiction herewith). The manufacturer is neither liable for damages caused by theft within an area that is accessible after the attached electric lock is switched. The product is not designed as a burglar protection device except when used in combination with a standard lock, which has the security function.
- When the proper mounting instructions are not met, water might get in and destroy the electronics. It is because the intercom circuits are under continuous voltage and water infiltration causes an electro-chemical reaction. The manufacturer's warranty shall be void for products damaged in this way!

Common Mounting Principles



Tips

- Select flush mounting where possible to make your product elegant looking, more vandal resistant and more secure.
- You can purchase the flush mounting box in advance and hire an installation professional to make the basic installation work. Moreover, the mounting box helps you align the intercom vertically (with a deviation of up to 2°).



Caution

- Make sure that the dowel holes have the required diameter. If the diameter is too large, the dowels may get loose. Use some suitable building adhesive to keep the dowels in place.
- Make sure that the hole depth is sufficient too! The dowel length is 50 mm and the screw length is 90 mm.
- Remember that dowels of poor quality may easily get loose and fall out of the wall!
- Stainless steel screws are used for the 2N[®] Helios IP Force assembly. Other screws than stainless steel ones corrode soon and may aesthetically deteriorate the surrounding environment!
- Having removed the front panel, make sure that no dirt gets inside the product (especially onto the sealing surface and microphone sound guides).



Note

- The microphone sound guides are normally loose after the front panel is removed! The screw is only used as a fall-out protection during installation.

Flush Mounting – Classic Bricks

If you use the brick flush mounting box, follow the instructions included in the box. If you do not use the mounting box, follow the instructions below:

1. Make a hole using the template. Suppose that all the required cables have been carried into the hole.
2. Unpack the frame, put the intercom inside and place the set onto the hole to make sure that the hole is deep enough and the uneven edge is perfectly covered with the frame.
3. Push or hammer the enclosed dowels into the drilled holes. Use some suitable building adhesive if the dowels are too loose.
4. Remove the front panel from the intercom. The electronic parts of the two bottom buttons remain on the panel in the four-name plate version.
5. Select the holes for cable supply. Insert the blanks into the other holes. Apply the cable bushings or a suitable sealant to prevent penetration of insects or water. You can also insert the small bushing in the intercom bottom hole.
6. Put the frame on the intercom.
7. Place the intercom into the hole while introducing the cables. Leave some of the cables inside the unit as a reserve and the rest under the intercom bottom.
8. Insert the enclosed screws in the lateral mounting holes making sure they have penetrated into the dowels. Tighten all the screws properly. Tip: The screw tightening sequence may affect the intercom position.
9. You can seal the frame - wall gap with a silicone or another sealant to avoid wall dampening as a result of water leakage. This additional sealing is unnecessary for the intercom function.
10. Do not complete mounting until you have finished electrical installation – refer to Mounting Completion

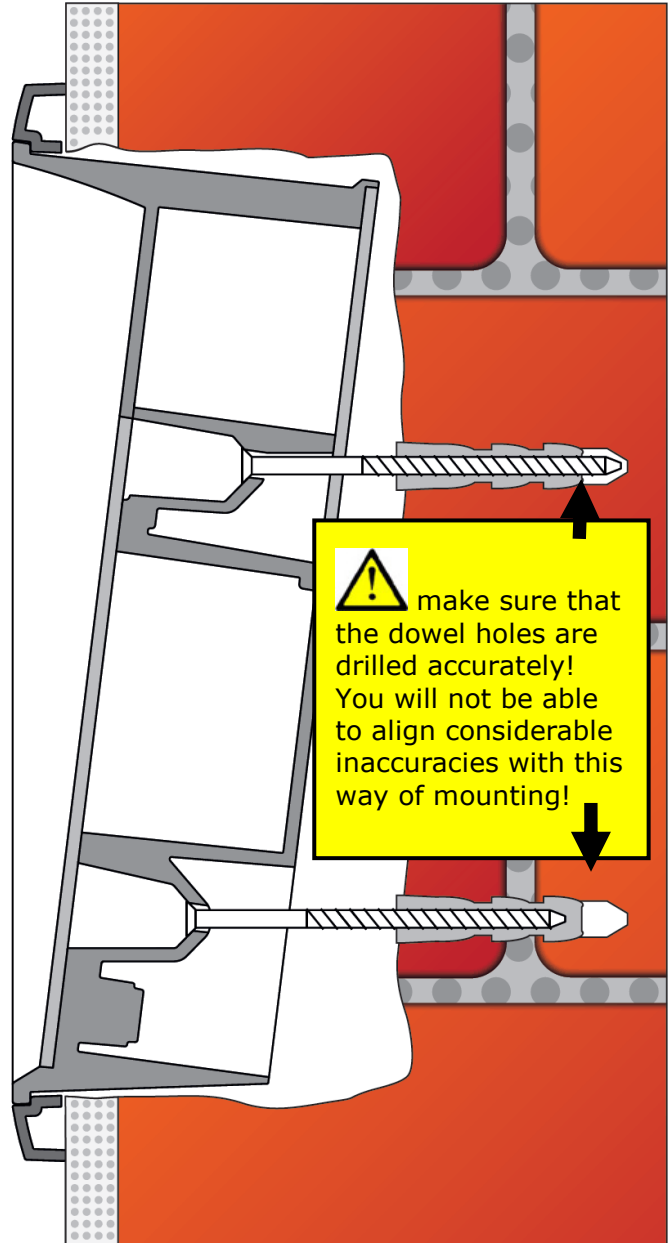

Flush Mounting – Thermally Insulated Wall

Cut out the thermal insulation layer using the template (the same as for classic brick wall).



Caution

- The hole depth depends on the insulation layer thickness. If the insulation layer is rather thick, you may need longer screws! If there are hollow bricks under the insulation, make sure that your screws pass through the whole dowel (50 mm) and fix the dowel reliably.
- Make sure that the dowel holes have the required diameter. If the diameter is too large, the dowels may get loose. Use some suitable building adhesive to keep the dowels in place.
- Make sure that the hole depth is sufficient too! The dowel length is 50 mm and the screw length is 90 mm.

Suppose that all the required cables have been carried into the drilled hole. Now follow the instructions applicable for classic brick flush mounting. However, remember that thermally insulated walls show less strength than classic brick walls.

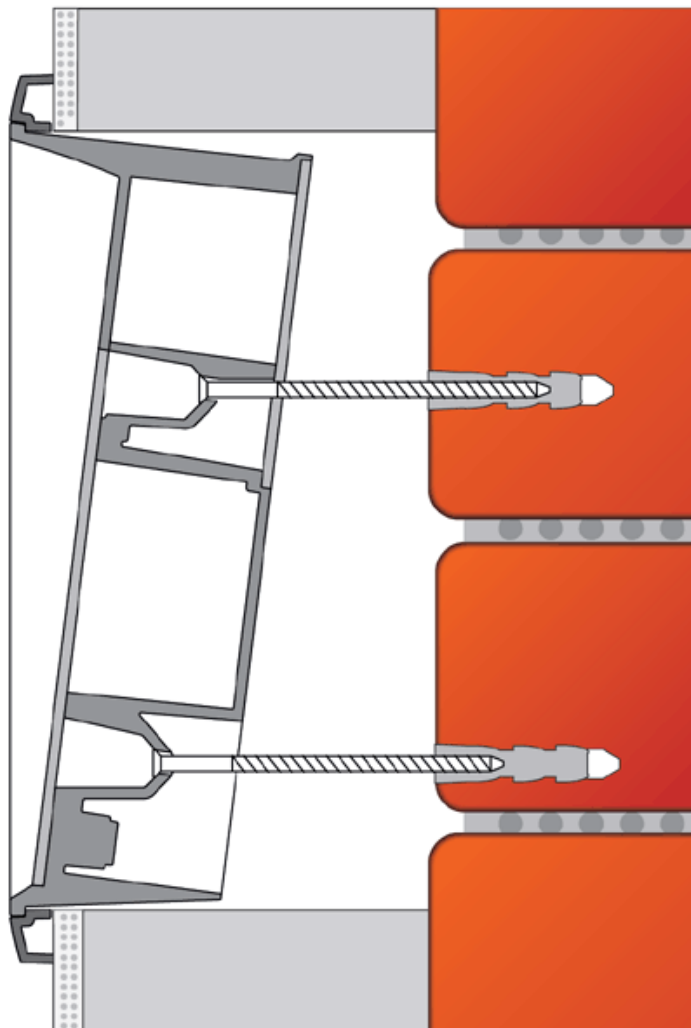

Flush Mounting – Hollow Bricks

Suppose you intend to install your 2N[®] Helios IP Force unit into a wall made of hollow bricks. Note that the external side of the bricks gets damaged by cutting and the dowels cannot practically be fixed into the thin internal part of the bricks. Therefore, use the brick flush mounting box and follow the instructions included therein.

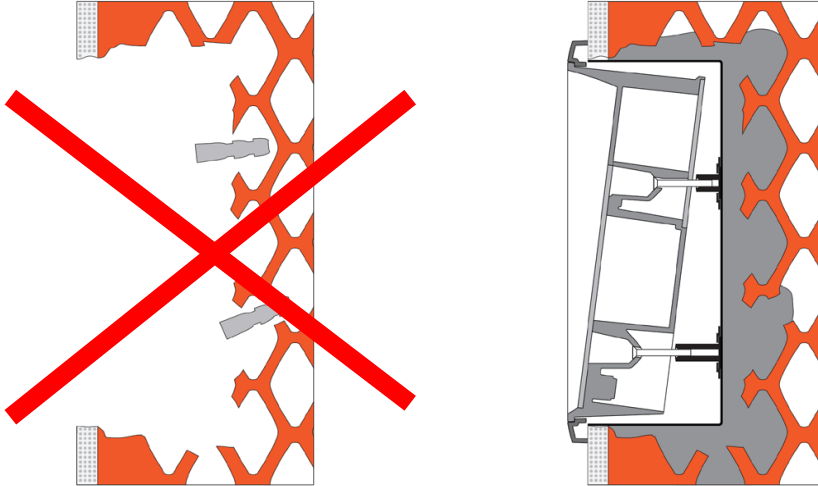

Flush Mounting – Plasterboard

Use the plasterboard flush mounting box and follow the instructions included therein.

Wall Mounting

Wall (surface) mounting is used where flush mounting is inapplicable (in concrete and steel structures, entry barrier columns, etc.). The frame is not used.



Caution

- Wall mounting may be a problem where vandals may destroy the unit (in public garages, e.g.). Therefore, use steel fixing elements instead of the dowels and screws included in the delivery.
- Be sure to insert plugs into unused bushing holes to avoid water leakage during facade cleaning, for example. Never leave the holes open for even a short time (one day delay between mounting and cable connection, e.g.).



Safety Warning

- Eliminate the risk of accident! Wall mounting is not suitable for narrow passages or places where people's attention may be distracted. The manufacturer shall not be liable for injuries incurred as a result of unsafe mounting!

1. Select the 2N® Helios IP Force position with respect to the supply cables. Where the cables are installed inside a structure or wall, use the hole at the intercom bottom.
2. Drill holes of the depth of 70 mm for dowels in the wall as shown in the figure. Push or hammer the enclosed dowels into the drilled holes. Use some suitable building adhesive if the dowels are too loose. Use fixing elements of your own for steel structure surface mounting (metric screws + nuts, e.g.).
3. Remove the front panel from the intercom. The electronic parts of the two bottom buttons remain on the panel in the four-name plate version.
4. Select the holes for cable supply. Select and mount the bushings depending on the cables: 2-hole bushing or 1-hole bushing or both. Insert the blanks in the other holes.
5. Put the intercom on the wall/structure while introducing cables inside. Leave some of the cables inside the unit as a reserve. Insert the plugs in the unused bushings and tighten the bushing nuts carefully.
6. Do not complete mounting until you have finished electrical installation – refer to Mounting Completion. Where cables lead along the surface, use the bushings included in the delivery.

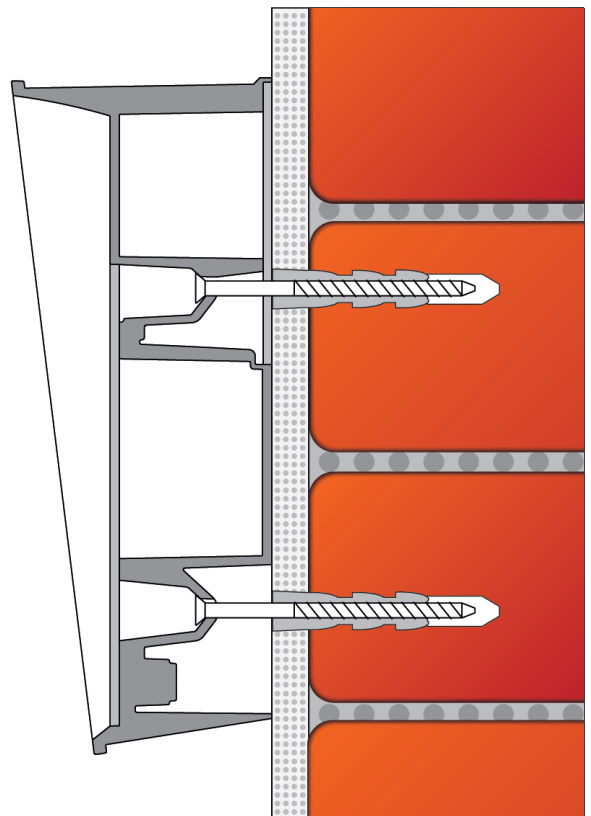

Use of Cable Bushings

The cable bushings included in the 2N® Helios IP Force delivery are designed for the following cables:

Big bushing: for two cables of the diameter of 5–6 mm (UTP cable), or, upon insert replacement, for one thick cable/tube of the diameter of up to 14 mm.

Small bushing: for one cable of the diameter of 5–8 mm.



Tip

- Even a LAN cable including the RJ-45 connector can go through the big bushing. See below for instructions.

How to Pull a RJ-45 Terminated Cable through a Bushing

1. Unscrew the big bushing nut completely.
2. Remove the sealing including the cover from the bushing. Cut either of the components as shown in the figures.

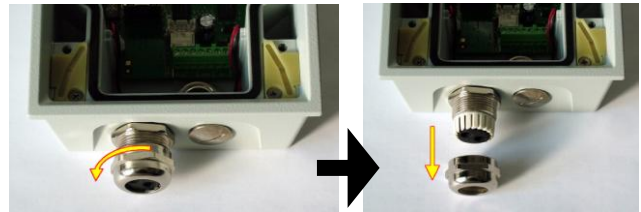

3. Put the bushing nut on the cable and insert the sealing.
4. Replace the cover onto the sealing.
5. Pull the cable connector through the bushing body into the intercom and clip it into the motherboard connector.
6. Move the sealing including the cover along the cable as far as the bushing body, or add a plug if necessary.
7. Replace and tighten the nut.

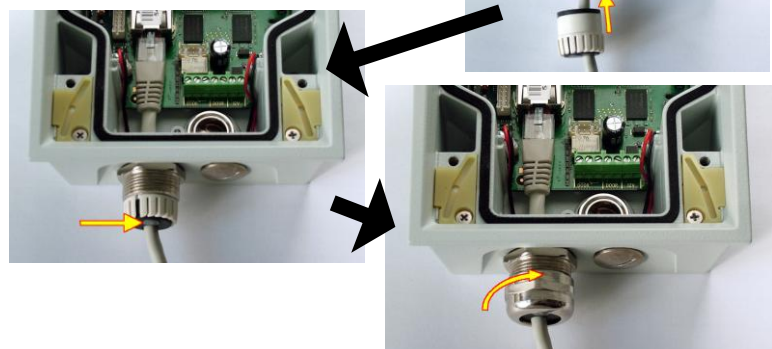
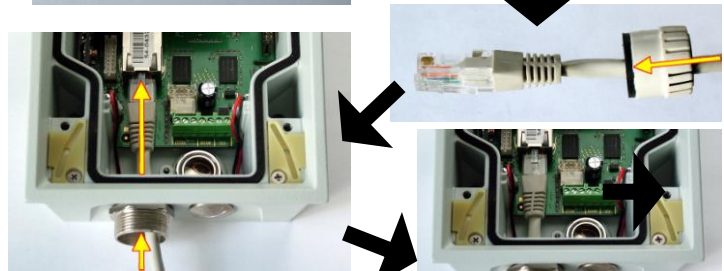
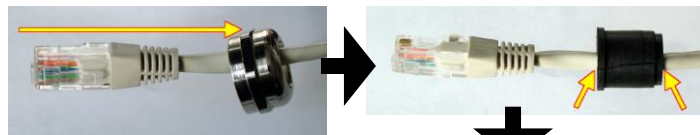

2.3 Electric Installation

This subsection describes how to connect 2N[®] Helios IP Force into your Local Area Network (LAN) and how to connect supply voltage and the electric lock.

PCB Connectors

Fig. 2.11 shows the lay-out of connectors on the 2N[®] Helios IP Force printed circuit board (PCB). Cables, accessories and other system components are connected to connectors X1 through X22.

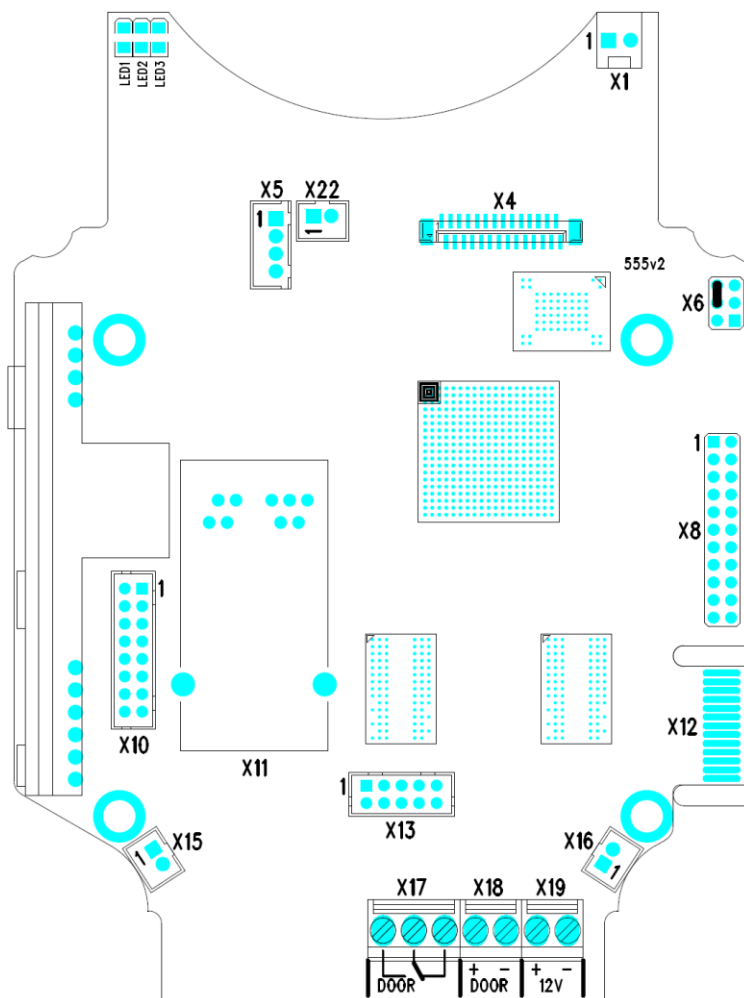

Figure 2.11 2N[®] Helios IP Force Connectors, PCB Version 530v2

Description of Connectors

X1	Loudspeaker
X4	Camera module
X5	Button 1
X6	Configuration jumpers
X8	Extending module (RFID card reader or additional switch)
X10	Buttons 1 through 4
X11	LAN
X12	Servicing connector
X13	Keypad module
X15	Left-hand microphone
X16	Right-hand microphone
X17	Relay NO and NC contact
X18	12V/700 mA switched output
X19	12V/1A DC power input
X22	Tamper switch

LED1/2	System status indicators
LED3	LAN connection activity indicator

LAN Connection

2N[®] Helios IP Force is connected to the LAN via a RJ-45 terminated (connector X11) UTP/STP cable (of category Cat 5e or higher). The system is equipped with the Auto-MDIX function and so both the straight and crossed cable versions can be used.

External Power Supply Connection

2N[®] Helios IP Force can be fed either from an external 12V/1A DC power supply or from the LAN equipped with the PoE 802.3af supporting network elements.

External Power Supply

An external 12V power supply is connected to terminal block X19. Use a 12V +- 15% DC power source dimensioned to current intake of 1A at least (Part No. 91341481E) to ensure a reliable function of your device.

PoE Supply

2N[®] Helios IP Force is compatible with the PoE 802.3af (Class 0 – 12.95W) technology and can be supplied directly from the LAN via compatible network elements. If your LAN is incompatible, insert the PoE injector, Part No. 91758100E, between 2N[®] Helios IP Force and the nearest network element.

Electric Lock Connection

2N® Helios IP Force is equipped with an electrically isolated relay switch with NO and NC contacts (terminal block X17) and 12V/700mA switched output (terminal block X18), to which a standard electric lock or another compatible electrical appliance can be connected.

Configuration Jumpers

Configuration jumpers (X6) are located in the right-hand upper corner of the PCB and help reset the factory default values.

Factory Default Resetting

1. Disconnect the device from the power supply.
2. Move the short-circuit jumper on connector X6 into the **Default setup** position.
3. Reconnect the power supply and wait for a start signalling sound.
4. Disconnect the device from the power supply.
5. Move the short-circuit jumper on connector X6 into the **Normal operation** position.
6. Reconnect the power supply. The device will be reset to factory default.



Normal operation	Default setup	Connector X6
		
		

Table 2.1 Configuration Jumpers X6

Mounting Completion

1. Having connected all the wires, make sure that the bushings, if used, are tightened properly and the RJ-45 connector is inserted in the PCB connector.
2. Replace the front cover carefully. Make sure that the connector is inserted correctly and the wires inside the device leave enough space for the board if you are installing a four-button board. Tighten the four screws thoroughly with the wrench enclosed (Torx 20) to make the panel fit tightly to the metal chassis.

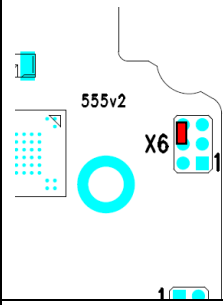

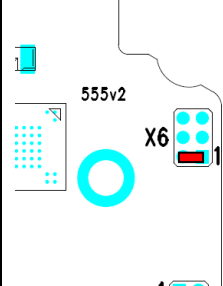
Caution

- An incorrect mounting may compromise the intercom watertightness. Water leakage may damage the electronic part of the system.
- Stainless steel screws are used for the 2N[®] Helios IP Force assembly. Other screws than stainless steel ones corrode soon and may aesthetically deteriorate the surrounding environment!

2.4 Button Tags – Insertion and Replacement

Tag Printing

1. Every 2N® Helios IP Force delivery includes a sheet of translucent foil, which can be laser-printed. Cut the printed foil and insert the tags in the name plates.
2. Every name plate includes a piece of foil, which can be written over manually, using a waterproof permanent marker, if necessary.



Note

- Always use waterproof foil (enclosed or other) for the tags. Never use paper or ink jet printing to avoid damage due to water leakage!

Tag Inserting / Replacing Instructions

2N® Helios IP Force provides an intuitive, easy access to the name plates. The tags are easy to insert and replace even without a manual. You need not remove the front panel and thus are not exposed to the risk of loss of components while replacing the tags.

1. Loosen the name plate screw using the wrench enclosed, for example. You can open the name plate window like a door without losing the tightened screw.
2. Remove the used or blank name tag and insert a new tag.
7. Close the name plate window and tighten the screw appropriately.
8. Check the click effect of the buttons: if the button fails to click properly when pressed (when moved by approx. 0.5 mm), the tag is too thick or thin. Make sure that the button clicks when you press it on both ends.

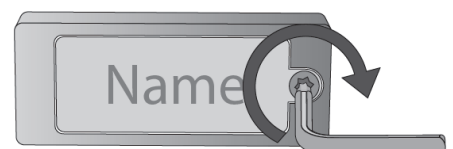
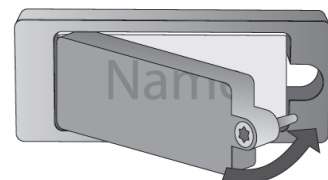
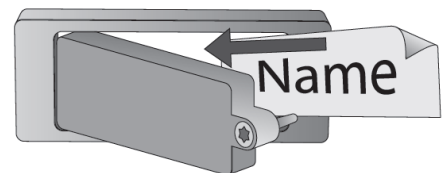
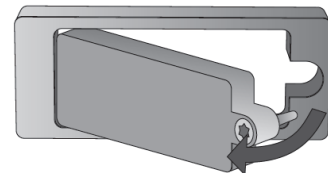
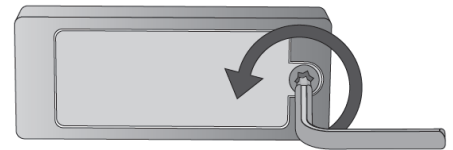

3

Function and Use

In this section we describe the basic and extending functions of the **2N® Helios IP Force** product.

Here is what you can find in this section:

- Configuration
- Control
- Maintenance

3.1 2N® Helios IP Force Configuration

Use a PC equipped with any web browser to configure **2N® Helios IP Force**:



- Launch your web browser (Internet Explorer, Firefox, etc.).
- Enter the IP address of your intercom (<http://192.168.1.100/>, e.g.).
- Log in using the **Admin** user name and **2n** password.

You have to know the IP address of your device to log in to the integrated web server. By default, 2N® Helios IP Force is switched into the dynamic IP address mode, i.e. it obtains the IP address automatically if a properly set DHCP server is available in your LAN. If no such DHCP server is available, you can operate 2N® Helios IP Force in the static IP address mode. Refer to the **2N® Helios IP Configuration Manual** for configuration details.

If your device remains inaccessible (you have forgotten the IP address, or the LAN configuration has changed, for example), change the LAN settings using the buttons on the device.

Static IP Address Setting

Follow the instructions below to enable the static IP address mode:

- Connect 2N® Helios IP Force to the power supply (or, disconnect and reconnect it if already connected).
- Wait for the first acoustic signal .
- Press buttons 1, 1, 1, 2, 2, 3 sequentially.
- The acoustic signal  indicates mode switching.
- Wait until the device is restarted automatically.

Note: The 1, 1, 1, 2, 2, 3 sequence must be entered within 30 seconds after the first sound signal for security reasons. The inter-digit delay may be 2s at most.



The device will have the following network parameters after restart:

IP address: 192.168.1.100
Network mask: 255.255.255.0
Default gateway: 192.168.1.1

Dynamic IP Address Setting

Follow the instructions below to enable automatic getting of network parameters from the DHCP server:

- Connect 2N® Helios IP Force to the power supply (or, disconnect and reconnect it if already connected).



- Wait for the first acoustic signal .
- Press buttons 2, 1, 1, 2, 2, 3 sequentially.
- The acoustic signal  indicates mode switching.
- Wait until the device is restarted automatically.

Note: The 2, 1, 1, 2, 2, 3 sequence must be entered within 30 seconds after the first sound signal for security reasons. The inter-digit delay may be 2s at most.

2N® Helios IP Force gets the IP address upon restart only if the DHCP server is configured properly.

Mode Switching with 1 or 2-Button Models

In case your 2N® Helios IP Force device is equipped with 1 or 2 buttons, you can switch the modes using one button only.

- Connect 2N® Helios IP Force to the power supply (or, disconnect and reconnect it if already connected).
- Wait for the first acoustic signal .
- Press button 1 15 times.
- The acoustic signal  indicates mode switching.
- Wait until the device is restarted automatically.

Note: The 15 times 1 sequence must be entered within 30 seconds after the first sound signal for security reasons. The inter-digit delay may be 2s at most.

The static IP address mode will be switched into the dynamic IP address mode and vice versa upon restart.

3.2 2N® Helios IP Force Control

This subsection describes how to control 2N® Helios IP Force when viewed by an external user.

Speed Dial Buttons

Press the speed dial buttons on the basic unit to make quick dialling for the first 1, 2 or 4 positions (depending on the model type) in the telephone directory. Call setup is signalled by a long intermittent tone or otherwise as configured in the PBX connected.

Repeated pressing of one and the same speed dial button during call setup may initiate call termination, or call termination plus dialling the next telephone number of the called subscriber, or may be assigned no function.

If your model is equipped with a numerical keypad, you can also push the # button anytime to terminate a call if enabled so in the **Hang up with #** parameter.

Calling to Telephone Directory Positions

The 2N® Helios IP Force telephone directory can contain up to 999 pre-programmed positions. Speed dial can only be used for positions 1 to 4. The remaining positions can be retrieved via the numerical keypad if the **Speed dial using digits** function is enabled.

Procedure: Enter the position number using your numerical keypad (05, 15, 200, e.g. – two digits at least and three digits at most) and press * for confirmation.

You can also push the # button anytime to terminate a call if enabled so in the **Hang up with #** parameter.

Calling to Telephone Number

You can dial a telephone number using your numerical keypad from 2N® Helios IP Force if the **Enable telephone function** parameter is on.

Procedure: Press the * button. You will hear the continuous tone from the loudspeaker. Enter the telephone number using the numerical keypad and repress * for confirmation.

You can also push the # button anytime to terminate a call if enabled so in the **Hang up with #** parameter; refer to the Miscellaneous subsection.

Answering and Rejecting Incoming Calls

If the automatic incoming call answering function is off, 2N® Helios IP Force signals an incoming call with loud ringing. Push the * button to answer the call and the # to reject the call. This function is available in models equipped with a numerical keypad only.

Door Opening (Switch Activation) by Code

2N® Helios IP Force is equipped with a door lock opening switch. Enter the valid code using your numerical keypad to activate the switch.

Procedure: Enter the numerical switch activating code using the numerical keypad and press * for confirmation.

A successful entering of a valid code is signalled by a continuous tone indicating unlocking (switch activation). An invalid code is signalled acoustically by --- .

User / Profile Activation and Deactivation

Activate/deactivate a user or a profile using the numerical keypad in order to define call routing to the telephone directory numbers more specifically.

Procedure: Enter the numerical user activating/deactivating code and press * for confirmation.

A successful entering of a valid code is signalled acoustically by --- (--- for profile) for activation, or --- (--- for profile) for deactivation. An invalid code is signalled acoustically by --- .

3.3 Maintenance

Cleaning

If used frequently, 2N[®] Helios IP Force gets dirty. To clean it, use a piece of soft cloth moistened with clean water. We recommend you to obey the following principles while cleaning:

- Never use aggressive detergents (such as abrasives or strong disinfectants).
- Use suitable cleaning agents for glass lens cleaning (cleaners for glasses, optic devices screens, etc.).
- Alcohol-based cleaners may be applied.
- Clean the device in dry weather in order to make waste water evaporate quickly.



Tip

- The 2N[®] Helios IP Force models of Part Nos. 9151101W and 9151101CW may be cleaned with WAP high pressure washers.

Future Tag Replacement, Programming Changes

For necessary steps refer to the preceding subsections. Keep the following for future changes:

- This manual
- Unused transparent foil strips for button tags

Always use the product for the purpose it was designed and manufactured for, in compliance herewith.

The manufacturer reserves the right to modify the product in order to improve its qualities.

2N Helios IP Force contains no environmentally harmful components. When the product's service life is exhausted and you would like to dispose of it please do so in accordance with applicable legal regulations.

4

Technical Parameters

In this section we describe the technical parameters of the **2N® Helios IP Force** product.

4.1 Technical Parameters

Signalling protocol	SIP (UDP)
Buttons	
Button design	Transparent, white backlit buttons with easily replaceable name tags
Count of buttons	1, 2 or 4
Numerical keypad	optional
Audio	
Microphone	2 integrated microphones
Amplifier	10W (class D)
Loudspeaker	1W (optionally 10W)
Volume control	Adjustable with automatic adaptive mode
Full duplex	Yes (AEC)
Audio stream	
Protocols	RTP/RTSP
Codecs	G.711, G.729
Camera	
Sensor	1/4" colour CMOS
Resolution	640 (H) x 480 (V)
Picture frequency	Up to 30 snaps/s
Sensitivity	1.9 V/lux-sec (550nm)
Viewing angle	135° (H), 109° (V)
Infrared illumination	Yes
Video stream	
Protocols	RTP/RTSP/HTTP
Codecs	H.263+, H.264, MPEG-4, M-JPEG
IP camera function	Yes
Interface	
Power supply	12V+-15%/1A DC or PoE
PoE	PoE 802.3af (Class 0 - 12.95W)
LAN	10/100BASE-TX s Auto-MDIX, RJ-45
Recommended cabling	Cat-5e or higher
Passive switch	NO and NC contacts, up to 30V/1A AC/DC
Active switch output	12V/700mA DC
RFID card reader	optional

Supported cards EM-40XX (125Khz)
HID Proximity (125kHz, 26bit)

Mechanical properties

Cover Robust aluminium cast product, stainless steel front panel
Working temperature -40°C to 55°C
Working relative humidity 10% - 95% (non-condensing)
Storing temperature -40°C to 70°C
Dimensions 217x109x83 mm
242x136x83 mm incl. frame
Weight netto max. 2 kg / brutto max. 2,5 kg
Covering level IP66 , IP69

5

Supplementary Information

This section provides supplementary information on the **2N® Helios IP Force** product.

Here is what you can find in this section:

- Applicable Directives, Laws and Regulations

5.1 Directives, Laws and Regulations

2N[®] Helios IP Force conforms to the following directives and regulations:

- Directive 1999/5/EC of the European Parliament and of the Council, of 9 March 1999 – on radio equipment and telecommunications terminal equipment and the mutual recognition of their conformity
- Directive 2006/95/EC of the European Parliament and of the Council of 12 December 2006 on the harmonisation of the laws of Member States relating to electrical equipment designed for use within certain voltage limits
- Directive 2004/108/EC of the Council of 15 December 2004 on the harmonisation of the laws of Member States relating to electromagnetic compatibility
- Directive 2002/95/EC of the European Parliament and of the Council of 27 January 2003 on the restriction of the use of certain hazardous substances in electrical and electronic equipment
- Regulation (EC) No. 1907/2006 of the European Parliament and of the Council of 18 December 2006 concerning the Registration, Evaluation, Authorisation and Restriction of Chemicals (REACH), establishing a European Chemicals Agency, amending Directive 1999/45/EC and repealing Council Regulation (EEC) No. 793/93 and Commission Regulation (EC) No. 1488/94 as well as Council Directive 76/769/EEC and Commission Directives 91/155/EEC, 93/67/EEC, 93/105/EC and 2000/21/EC
- Directive 2002/96/EC of the European Parliament and of the Council of 27 January 2003 on waste electrical and electronic equipment.
- Commission Regulation (EC) No. 1275/2008, of 17 December 2008, implementing Directive 2005/32/EC of the European Parliament and of the Council with regard to ecodesign requirements for standby and off mode electric power consumption of electrical and electronic household and office equipment

5.2 Troubleshooting



For tips concerning solutions of other potential problems see faq.2n.cz.

5.3 General Instructions and Cautions

Please read this User Manual carefully before using the product. Follow all instructions and recommendations included herein.

Any use of the product that is in contradiction with the instructions provided herein may result in malfunction, damage or destruction of the product.

The manufacturer shall not be liable and responsible for any damage incurred as a result of a use of the product other than that included herein, namely undue application and disobedience of the recommendations and warnings in contradiction herewith.

Any use or connection of the product other than those included herein shall be considered undue and the manufacturer shall not be liable for any consequences arisen as a result of such misconduct.

Moreover, the manufacturer shall not be liable for any damage or destruction of the product incurred as a result of misplacement, incompetent installation and/or undue operation and use of the product in contradiction herewith.

The manufacturer assumes no responsibility for any malfunction, damage or destruction of the product caused by incompetent replacement of parts or due to the use of reproduction parts or components.

The manufacturer shall not be liable and responsible for any loss or damage incurred as a result of a natural disaster or any other unfavourable natural condition.

The manufacturer shall not be held liable for any damage of the product arising during the shipping thereof.

The manufacturer shall not make any warrant with regard to data loss or damage.

The manufacturer shall not be liable and responsible for any direct or indirect damage incurred as a result of a use of the product in contradiction herewith or a failure of the product due to a use in contradiction herewith.

All applicable legal regulations concerning the product's installation and use as well as provisions of technical standards on electric installations have to be obeyed. The manufacturer shall not be liable and responsible for damage or destruction of the product or damage incurred by the consumer in case the product is used and handled contrary to the said regulations and provisions.

The consumer shall, at its own expense, obtain software protection of the product. The manufacturer shall not be held liable and responsible for any damage incurred as a result of the use of deficient or substandard security software.

The consumer shall, without delay, change the access password for the product after installation. The manufacturer shall not be held liable or responsible for any damage incurred by the consumer in connection with the use of the original password.

The manufacturer also assumes no responsibility for additional costs incurred by the consumer as a result of making calls using a line with an increased tariff.

Electric Waste and Used Battery Pack Handling



Do not place used electric devices and battery packs into municipal waste containers. An undue disposal thereof might impair the environment!

Deliver your expired electric appliances and battery packs removed from them to dedicated dumpsites or containers or give them back to the dealer or manufacturer for environmental-friendly disposal. The dealer or manufacturer shall take the product back free of charge and without requiring another purchase. Make sure that the devices to be disposed of are complete.

Do not throw battery packs into fire. Battery packs may not be taken into parts or short-circuited either.



2N TELEKOMUNIKACE a.s.

Modřanská 621, 143 01 Prague 4, Czech Republic

Tel.: +420 261 301 500, Fax: +420 261 301 599

E-mail: sales@2n.cz

Web: www.2n.cz

DR1755 v1.0