

SmartNode 4520 & 4110 Series **VoIP Gateway Routers**

Getting Started Guide



Trademark Statement

The terms *SmartWare* and *SmartView* are trademarks of Patton Electronics Company. All other trademarks presented in this document are the property of their respective owners.

Copyright © 2003–2006, Patton Electronics Company. All rights reserved.

The information in this document is subject to change without notice. Patton Electronics assumes no liability for errors that may appear in this document.

Warranty Information

The software described in this document is furnished under a license and may be used or copied only in accordance with the terms of such license.

Patton Electronics warrants all SmartNode router components to be free from defects, and will—at our option—repair or replace the product should it fail within one year from the first date of the shipment.

This warranty is limited to defects in workmanship or materials, and does not cover customer damage, abuse or unauthorized modification. If the product fails to perform as warranted, your sole recourse shall be repair or replacement as described above. Under no condition shall **Patton Electronics** be liable for any damages incurred by the use of this product. These damages include, but are not limited to, the following: lost profits, lost savings and incidental or consequential damages arising from the use of or inability to use this product. **Patton Electronics** specifically disclaims all other warranties, expressed or implied, and the installation or use of this product shall be deemed an acceptance of these terms by the user.

Contents

Contents	3
Compliance information	7
Radio and TV interference	7
CE notice	7
Service	7
About this guide	9
Audience.....	9
Structure.....	9
Precautions	10
Safety when working with electricity	10
Preventing electrostatic discharge damage	11
General observations	11
Typographical conventions used in this document.....	12
General conventions	12
1 General information	13
SmartNode Series VoIP routers overview.....	15
SmartNode 4520 Series router	16
Ports descriptions	18
SmartNode 4110 Series router	20
Ports descriptions	22
2 Applications overview	25
Introduction	27
Applications for SmartNode 4110 Series	27
SIP and H.323 terminal and PSTN gateways	27
Application—Analog line extension over IP	28
Application—ITSP dial-in access	28
Application—Private line automatic ringdown (PLAR)	29
Application—Enterprise campus BRI to FXS telephony extension	29
Application—PBX toll bypass gateway	30
Applications for SmartNode 4520 Series	30
Application—SOHO off-premise extension	31
Application—Single-phone PSTN and VoIP access	32
3 Hardware installation	33
Planning the installation	35
Installation checklist	36
Site log	37
Network information	37
Network Diagram	37
IP related information	37

Software tools	37
Power source	37
Location and mounting requirements	38
Installing the gateway router	38
Mounting the gateway router	38
Connecting cables	38
Installing an interface cable on the router's FXS and FXO interface ports	39
Installing the Ethernet cable	41
Connecting to external power source	43
4 Getting started with the SmartNode.....	45
Introduction	47
1. Configure IP address	48
Power connection and default configuration	48
Connect with the serial interface	48
Login	49
Changing the IP address	49
2. Connect the SmartNode to the network.....	50
3. Load configuration	50
Additional information.....	51
5 LEDs status and monitoring	53
Status LEDs.....	55
6 Contacting Patton for assistance	59
Introduction.....	61
Contact information.....	61
Warranty Service and Returned Merchandise Authorizations (RMAs).....	61
Warranty coverage	61
Out-of-warranty service	61
Returns for credit	61
Return for credit policy	62
RMA numbers	62
Shipping instructions	62
A Specifications	63
DSP.....	65
Voice connectivity	65
Connectivity.....	65
Voice processing (signalling dependent).....	65
Fax and modem support.....	65
Voice signalling	66
Voice routing—session router.....	66
IP services.....	66
Management	67
Operating environment	67

Operating temperature	67
Operating humidity	67
System	67
Compliance	67
Dimensions	67
Weight and power dissipation	68
Power supply	68
AC version	68
DC version	68
B Cabling	69
Introduction	71
Serial console	71
Ethernet 10Base-T and 100Base-T	72
Analog FXS	73
Analog FXO	74
C Port pin-outs	75
Introduction	77
Console port	77
Ethernet 10Base-T and 100Base-T port	77
FXS port	77
FXO port	78
D SmartNode 4110 Series factory configuration	79
Introduction	81
E SmartNode 4520 Series factory configuration	83
Introduction	85
F Installation checklist	87
Introduction	89

Compliance information

Radio and TV interference

The SmartNode router generates and uses radio frequency energy, and if not installed and used properly—that is, in strict accordance with the manufacturer’s instructions—may cause interference to radio and television reception. The SmartNode router have been tested and found to comply with the limits for a Class A computing device in accordance with specifications in Subpart B of Part 15 of FCC rules, which are designed to provide reasonable protection from such interference in a commercial installation. However, there is no guarantee that interference will not occur in a particular installation. If the SmartNode router does cause interference to radio or television reception, which can be determined by disconnecting the unit, the user is encouraged to try to correct the interference by one or more of the following measures: moving the computing equipment away from the receiver, re-orienting the receiving antenna and/or plugging the receiving equipment into a different AC outlet (such that the computing equipment and receiver are on different branches).



Disconnect all power before servicing.



The SmartNode router contains no user serviceable parts.



The mains outlet that is utilized to power the equipment must be within 1 foot (3 meters) of the device and shall be easily accessible.

CE notice

The CE symbol on your Patton Electronics equipment indicates that it is in compliance with the Electromagnetic Compatibility (EMC) directive and the Low Voltage Directive (LVD) of the European Union (EU).

Service

All warranty and non-warranty repairs must be returned freight prepaid and insured to Patton Electronics. All returns must have a Return Materials Authorization number on the outside of the shipping container. This number may be obtained from Patton Electronics Technical Services at:

- Tel: **+1 (301) 975-1007**
- Email: **support@patton.com**
- URL: **www.patton.com**

Note Packages received without an RMA number will not be accepted.

About this guide

This guide describes the SmartNode 4110 and 4520 Series hardware, installation and basic configuration. For detailed software configuration information refer to the *SmartWare Software Configuration Guide* and the available Configuration Notes.

Audience

This guide is intended for the following users:

- Operators
- Installers
- Maintenance technicians

Structure

This guide contains the following chapters and appendices:

- [Chapter 1](#) on page 13 provides information about router features and capabilities
- [Chapter 2](#) on page 25 contains an overview describing router operation and applications
- [Chapter 3](#) on page 33 provides quick start hardware installation procedures
- [Chapter 4](#) on page 45 describes getting started with the SmartNode router
- [Chapter 5](#) on page 53 contains definitions for the LED status indicators
- [Chapter 6](#) on page 59 contains information on contacting Patton technical support for assistance
- [Appendix A](#) on page 63 contains specifications for the routers
- [Appendix B](#) on page 69 provides cable recommendations
- [Appendix C](#) on page 75 describes the router's ports and pin-outs
- [Appendix D](#) on page 79 lists the factory configuration settings for SmartNode 4110 Series devices
- [Appendix E](#) on page 83 lists the factory configuration settings for SmartNode 4520 Series devices
- [Appendix F](#) on page 87 lists the tasks for installing a SmartNode 4520 or 4110 Series router

For best results, read the contents of this guide *before* you install the router.

Precautions

Notes and cautions, which have the following meanings, are used throughout this guide to help you become aware of potential Router problems. *Warnings* relate to personal injury issues, and *Cautions* refer to potential property damage.

Note Calls attention to important information.



The shock hazard symbol and **WARNING** heading indicate a potential electric shock hazard. Strictly follow the warning instructions to avoid injury caused by electric shock.



The alert symbol and **WARNING** heading indicate a potential safety hazard. Strictly follow the warning instructions to avoid personal injury.



The shock hazard symbol and **CAUTION** heading indicate a potential electric shock hazard. Strictly follow the instructions to avoid property damage caused by electric shock.



The alert symbol and **CAUTION** heading indicate a potential hazard. Strictly follow the instructions to avoid property damage.

Safety when working with electricity



Mains Voltage: Do not open the case when the power cord is connected. For systems without a power switch, line voltages are present within the power supply when the power cord is connected.



Hazardous network voltages are present in WAN ports regardless of whether power to the SmartNode is **ON** or **OFF**. To avoid electric shock, use caution when near WAN ports. When detaching cables, detach the end away from the SmartNode first.



Do not work on the system or connect or disconnect cables during periods of lightning activity.



Before opening the chassis, disconnect the telephone network cables to avoid contact with telephone line voltages.



Ultimate disposal of this equipment must be handled according to all applicable national laws and regulations.

Preventing electrostatic discharge damage

When starting to install interface cards place the interface card on its shielded plastic bag if you lay it on your bench.



Electrostatic Discharge (ESD) can damage equipment and impair electrical circuitry. It occurs when electronic printed circuit cards are improperly handled and can result in complete or intermittent failures. Do the following to prevent ESD:

- Always follow ESD prevention procedures when removing and replacing cards.
- Wear an ESD-preventive wrist strap, ensuring that it makes good skin contact. Connect the clip to an unpainted surface of the chassis frame to safely channel unwanted ESD voltages to ground.
- To properly guard against ESD damage and shocks, the wrist strap and cord must operate effectively. If no wrist strap is available, ground yourself by touching the metal part of the chassis.

General observations

- Clean the case with a soft slightly moist anti-static cloth
- Place the unit on a flat surface and ensure free air circulation
- Avoid exposing the unit to direct sunlight and other heat sources
- Protect the unit from moisture, vapors, and aggressive liquids

Typographical conventions used in this document

This section describes the typographical conventions and terms used in this guide.

General conventions

The procedures described in this manual use the following text conventions:

Table 1. General conventions

Convention	Meaning
Garamond blue type	Indicates a cross-reference hyperlink that points to a figure, graphic, table, or section heading. Clicking on the hyperlink jumps you to the reference. When you have finished reviewing the reference, click on the Go to Previous View button  in the Adobe® Acrobat® Reader toolbar to return to your starting point.
Futura bold type	Commands and keywords are in boldface font.
<i>Futura bold-italic type</i>	Parts of commands, which are related to elements already named by the user, are in boldface italic font.
<i>Italicized Futura type</i>	Variables for which you supply values are in <i>italic</i> font
Futura type	Indicates the names of fields or windows.
Garamond bold type	Indicates the names of command buttons that execute an action.
< >	Angle brackets indicate function and keyboard keys, such as <SHIFT>, <CTRL>, <C>, and so on.
[]	Elements in square brackets are optional.
{a b c}	Alternative but required keywords are grouped in braces ({ }) and are separated by vertical bars ()
blue screen	Information you enter is in blue screen font.
screen	Terminal sessions and information the system displays are in screen font.
node	The leading IP address or nodename of a SmartNode is substituted with node in boldface italic font.
SN	The leading SN on a command line represents the nodename of the SmartNode
#	An hash sign at the beginning of a line indicates a comment line.

Chapter 1 **General information**

Chapter contents

SmartNode Series VoIP routers overview.....	15
SmartNode 4520 Series router	16
Ports descriptions	18
SmartNode 4110 Series router	20
Ports descriptions	22

SmartNode Series VoIP routers overview

The SmartNode 4520 and 4110 Series VoIP Gateway Routers (see [figure 1](#)) combine IP routing, VPN/Security, and Quality of Service for up to 8 transparent voice and FAX calls over any IP or PSTN network. Leverage low-cost IP services with packet-voice for complete branch office voice and data connectivity.



Figure 1. SmartNode Router (SmartNode 4524 shown)

The SmartNode 4520 Series Gateway Routers, equipped with two 10/100Base-T Ethernet ports provide; voice over IP (VoIP) and Internet telephony plus Internet access routing, VPN and firewall functions, and extensive Quality of Service (QoS) functions.

The SmartNode 4110 Series Media Gateways, equipped with a single 10/100Base-T Ethernet port that provide VoIP and Internet telephony.

The SmartNode VoIP Gateways and Gateway-Routers perform the following major functions:

- Voice over IP and local switching via a combination of 2 to 8 analog phone ports (FXS) and 2 to 4 analog line ports (FXO).
- Standard compliant VoIP conversion in accordance with SIP and H.323 protocols.
- Internet access and IP Routing (4520 Series only) with IP Quality of Service (QoS) support for mixed voice and data traffic.

Section “[SmartNode 4520 Series router](#)” on page 16 provides more information on the SmartNode 4520 Series. Section “[SmartNode 4110 Series router](#)” on page 20 describes the SmartNode 4110 Series.

SmartNode 4520 Series router

The SmartNode 4520 Series are compact VoIP Gateway Routers that support two to eight VoIP calls and various combinations of FXS and FXO ports (see [figure 2](#)).

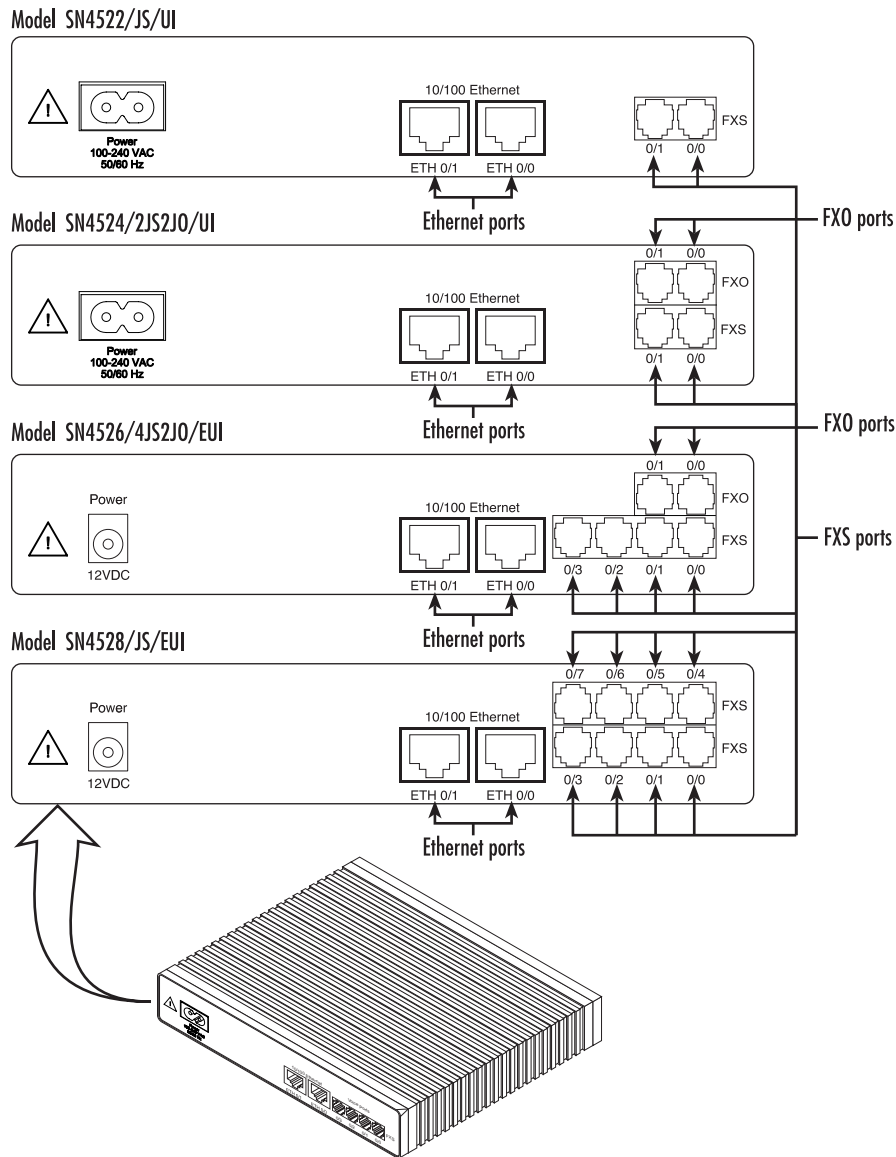

Figure 2. Examples of SN4520 Series rear panels

The following base models (each equipped with two 10/100Base-T Ethernet ports) are available:

- SmartNode 4522 (2 VoIP calls)
- SmartNode 4524 (4 VoIP calls)
- SmartNode 4526 (6 VoIP calls)
- SmartNode 4528 (8 VoIP calls)

The port combinations are indicated in the extension of the model code. The products the following model code conventions apply:

- *JS* stands for FXS ports
- *JO* stands for FXO ports
- *UI* stands for integrated universal input power supply (see figure 3)
- *EUI* stands for external universal input power supply (see figure 3)

For example, the model code *SN4526/4JS2JO/EUI* describes a SmartNode configured as follows:

- 4 FXS ports
- 2 FXO ports
- External power supply

Note For a complete listing of available models, refer to the SmartNode VoIP page at <http://www.patton.com/voip/>.

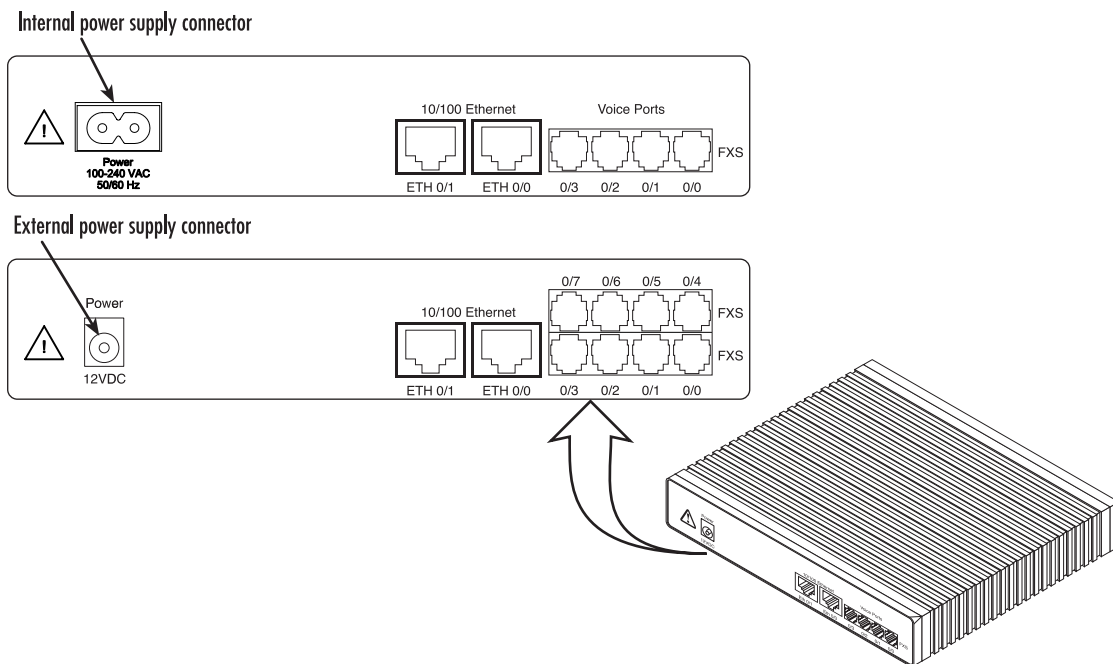

Figure 3. SmartNode 4520 Series power input connectors

Ports descriptions

The SmartNode 4520 Series rear panel ports are described in [table 2](#).

Table 2. Rear panel ports

Port	Location	Description
10/100 Ethernet ETH 0/0 & ETH 0/1	Rear panel	RJ-45 connectors (see figure 16 on page 39) that connect the router to an Ethernet device (e.g., a cable or DSL modem, LAN hub or switch).
Analog voice port, FXS	Rear panel	FXS RJ-11 (6 position, 4 wire) connectors (see figure 16 on page 39) that connect the router with an analog terminal (a telephone, for example) FXO port. EuroPOTS support (ETSI EG201 188). FXS on-hook voltage is 48V for each FXS port.
Analog voice port, FXO	Rear panel	FXO RJ-11 (6 position, 4 wire) connectors (see figure 16 on page 39) that connect the router with an analog line (FXS port). EuroPOTS support (ETSI EG201 188).
Power	Rear panel	The gateway is available in a DC or AC power input version (see figure 3), labeled as follows: <ul style="list-style-type: none"> • AC version (Internal power supply): 100–240 VAC, 50/60 Hz, 200 mA • DC version: 12 VDC, 1.25 A
Console	Front panel	Used for service and maintenance, the Console port (see figure 4 on page 19), an RS-232 RJ-45 connector, connects the router to a serial terminal such as a PC or ASCII terminal (also called a dumb terminal).

Reset button behavior

For those SmartNode devices that have a *Reset* button on the rear panel, its behavior is as follows:

- To restart the unit with the current startup configuration—Press for less than 1 second and release the *Reset* button. The SmartNode will restart with the current startup configuration.
- To restart the unit with factory default configuration—Press the *Reset* button for 5 seconds until the Power LED starts blinking. The unit will restart with factory default configuration.
- To restart the unit in bootloader mode (to be used only by trained SmartNode technicians)—Start with the unit powered off. Press and hold the *Reset* button while applying power to the unit. Release the *Reset* button when the *Power* LED starts blinking so the unit will enter bootloader mode.

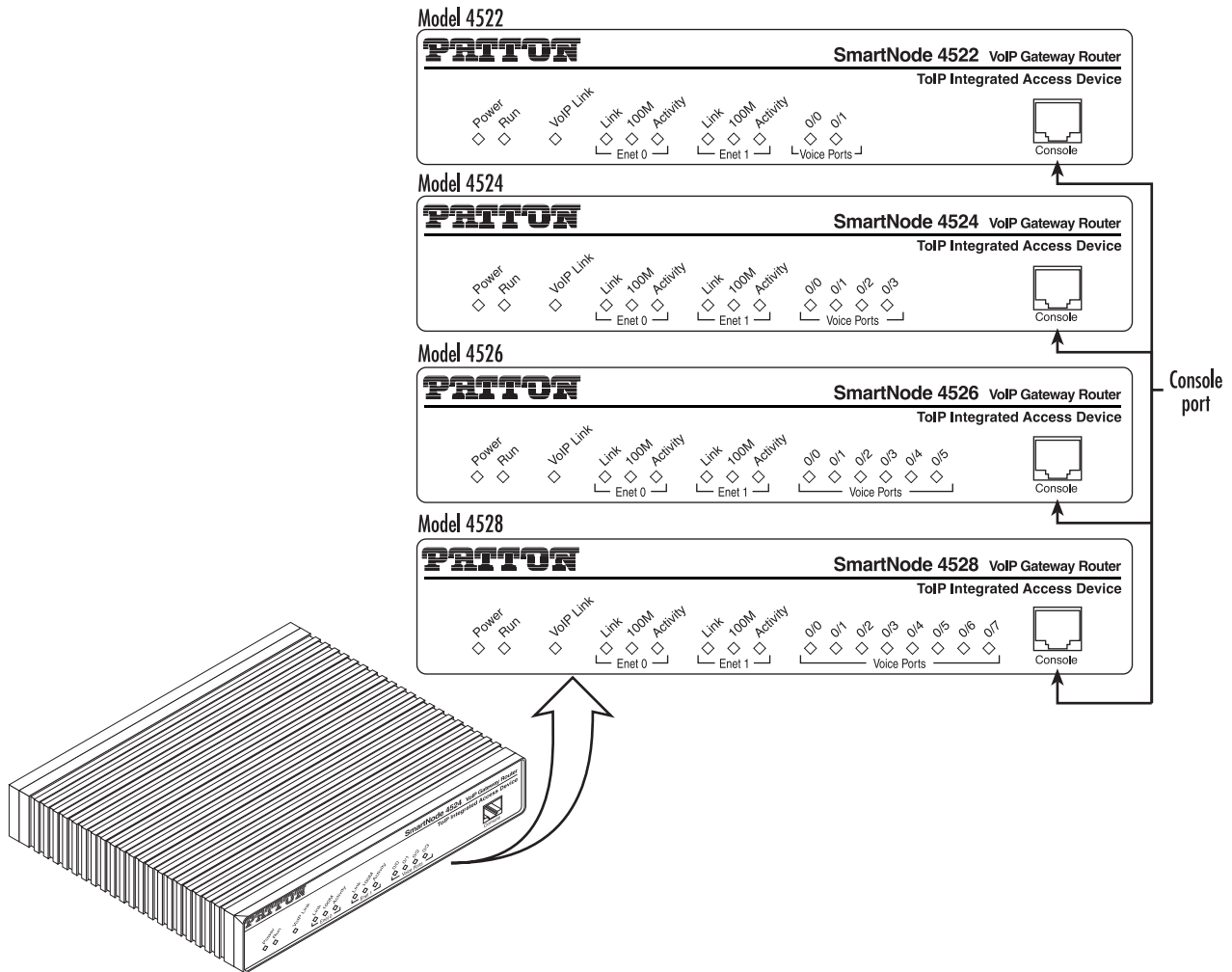

Figure 4. SmartNode 4520 Series front panels

Note For LED descriptions, refer to chapter 5, “LEDs status and monitoring” on page 53.

SmartNode 4110 Series router

The SmartNode 4110 Series are compact VoIP Gateways that support two to eight VoIP calls and various combinations of FXS and FXO ports (see figure 5).

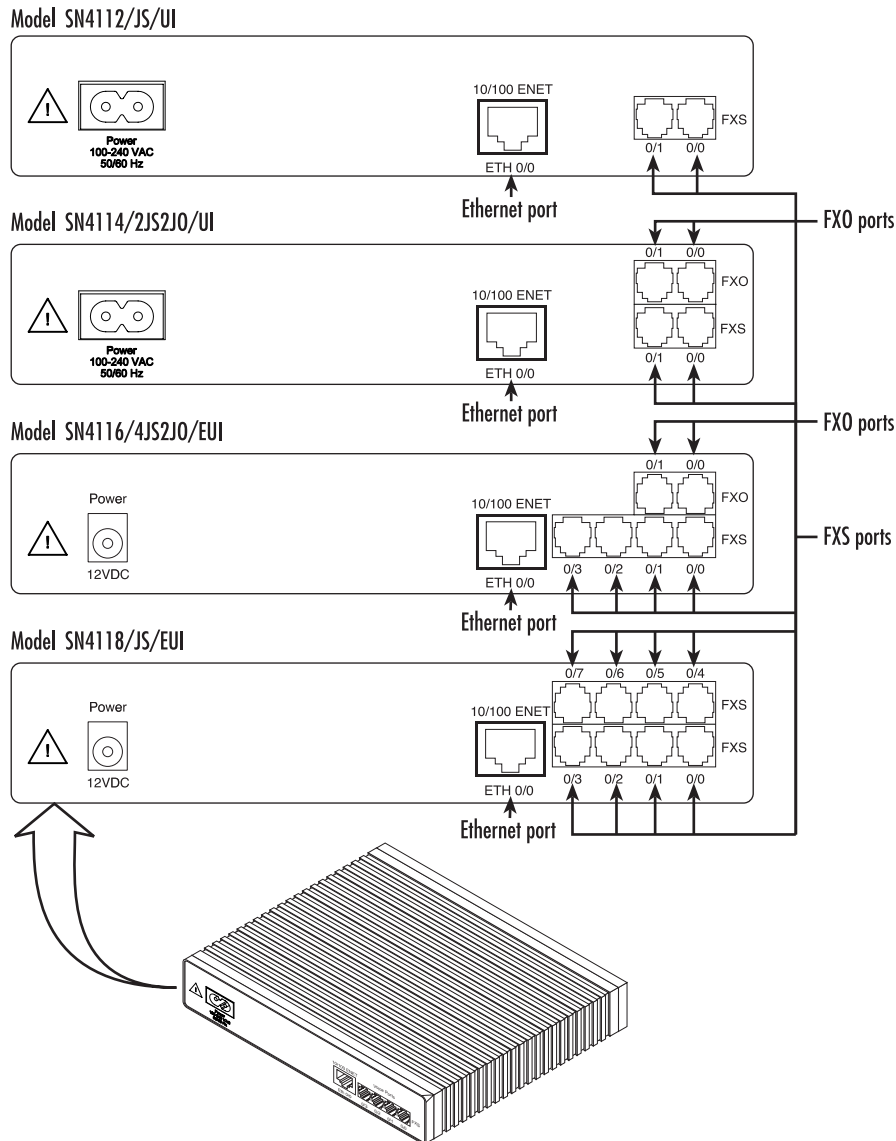

Figure 5. Examples of SN4110 Series rear panels

The following base models (each equipped with one 10/100Base-T Ethernet port) are available:

- SmartNode 4112 (2 VoIP calls)
- SmartNode 4114 (4 VoIP calls)
- SmartNode 4116 (6 VoIP calls)
- SmartNode 4118 (8 VoIP calls)

The port combinations are indicated in the extension of the model code. The products the following model code conventions apply:

- *JS* stands for FXS ports
- *JO* stands for FXO ports
- *UI* stands for integrated universal input power supply (see figure 6)
- *EUI* stands for external universal input power supply (see figure 6)

For example, the model code *SN4116/4JS2JO/EUI* describes a SmartNode configured as follows:

- 4 FXS ports
- 2 FXO ports
- External power supply

Note For a complete listing of available models, refer to the SmartNode VoIP page at <http://www.patton.com/voip/>.

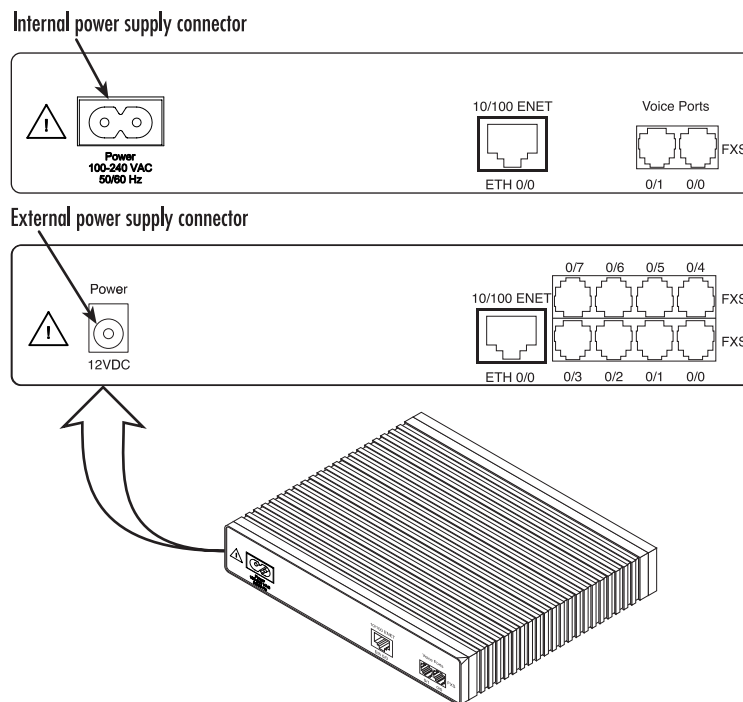

Figure 6. SmartNode 4110 Series power input connectors

Ports descriptions

The SmartNode 4110 Series rear panel ports are described in [table 3](#).

Table 3. Rear panel ports

Port	Location	Description
10/100 Ethernet ETH 0/0	Rear panel	RJ-45 connector (see figure 5 on page 20) that connects the router to an Ethernet device (a cable or DSL modem, LAN hub or switch, for example).
Analog voice port, FXS	Rear panel	FXS RJ-11 (6 position, 4 wire) connectors (see figure 16 on page 39) that connect the router with an analog terminal (a telephone, for example) FXO port. EuroPOTS support (ETSI EG201 188).
Analog voice port, FXO	Rear panel	FXO RJ-11 (6 position, 4 wire) connectors (see figure 16 on page 39) that connect the router with an analog line (FXS port). EuroPOTS support (ETSI EG201 188).
Power	Rear panel	The gateway is available in a DC or AC power input version (see figure 6), labeled as follows: <ul style="list-style-type: none"> • AC version (Internal power supply): 100–240 VAC, 50/60 Hz, 200 mA • DC version: 12 VDC, 1.25 A
Console	Front panel	Used for service and maintenance, the Console port (see figure 7 on page 23), an RS-232 RJ-45 connector, connects the router to a serial terminal such as a PC or ASCII terminal (also called a dumb terminal).

Reset button behavior

For those SmartNode devices that have a *Reset* button on the rear panel, its behavior is as follows:

- To restart the unit with the current startup configuration—Press for less than 1 second and release the *Reset* button. The SmartNode will restart with the current startup configuration.
- To restart the unit with factory default configuration—Press the *Reset* button for 5 seconds until the Power LED starts blinking. The unit will restart with factory default configuration.
- To restart the unit in bootloader mode (to be used only by trained SmartNode technicians)—Start with the unit powered off. Press and hold the *Reset* button while applying power to the unit. Release the *Reset* button when the *Power* LED starts blinking so the unit will enter bootloader mode.

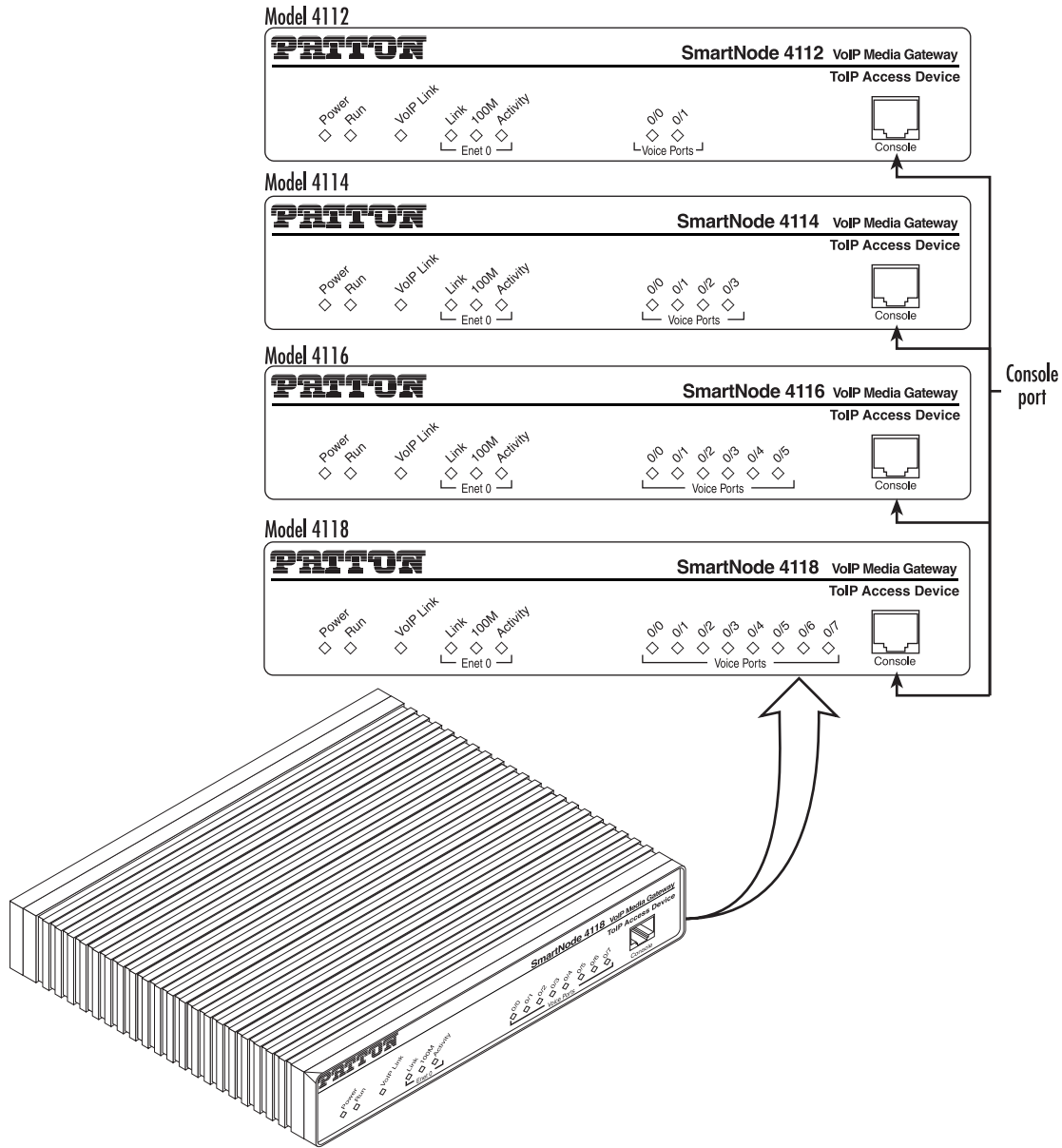

Figure 7. SmartNode 4110 Series front panels

Note For LED descriptions, refer to chapter 5, “LEDs status and monitoring” on page 53.

Chapter 2 **Applications overview**

Chapter contents

Introduction	27
Applications for SmartNode 4110 Series	27
SIP and H.323 terminal and PSTN gateways	27
Application—Analog line extension over IP	28
Application—ITSP dial-in access	28
Application—Private line automatic ringdown (PLAR)	29
Application—Enterprise campus BRI to FXS telephony extension	29
Application—PBX toll bypass gateway	30
Applications for SmartNode 4520 Series	30
Application—SOHO off-premise extension	31
Application—Single-phone PSTN and VoIP access	32

Introduction

Patton's SmartNode Media Gateway Routers deliver the features you need for advanced multiservice voice and data network applications. They combine high quality voice-over-IP with powerful *quality of service* routing functions to build professional and reliable VoIP networks. This chapter describes typical applications for which the SmartNodes are uniquely suited.

Note Detailed configuration information for the applications can be found on the CD-ROM that was included with your SmartNode device or online from the Patton webserver.

Applications for SmartNode 4110 Series

The SmartNode 4110 Series device, equipped with a single Ethernet port, provides gateway and over-IP line extension services.

SIP and H.323 terminal and PSTN gateways

All models provide *voice-over-IP* and *FAX-over-IP* services for integration into a VoIP network running the SIP or H.323 protocol (see [figure 8](#)). The SmartNode 4110 Series supports automatic registration to a Gatekeeper or SIP server to provide analog extension services or PSTN breakout connectivity.

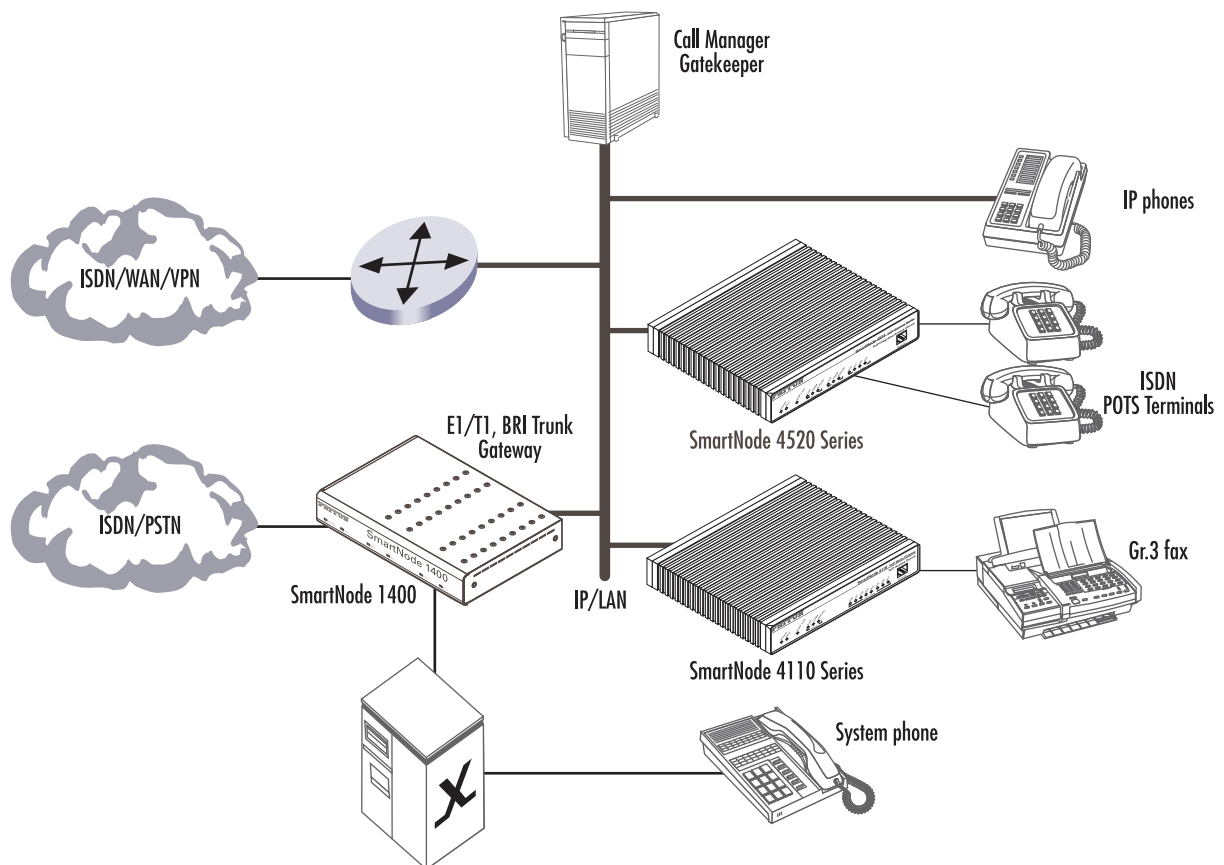

Figure 8. PSTN and Terminal gateways

Application—Analog line extension over IP

A virtual analog line can be created using an FXO and FXS model (see figure 9). The complete signaling and media (voice, fax, or modem) of the analog phone line is extended over IP. This enables a PBX analog extension line to be extended to a home office or satellite office. The analog line extension relays DTMF, hook-flash and CLI to provide full PBX feature access over the IP network (checking voice mail or joining a calling group, for example).

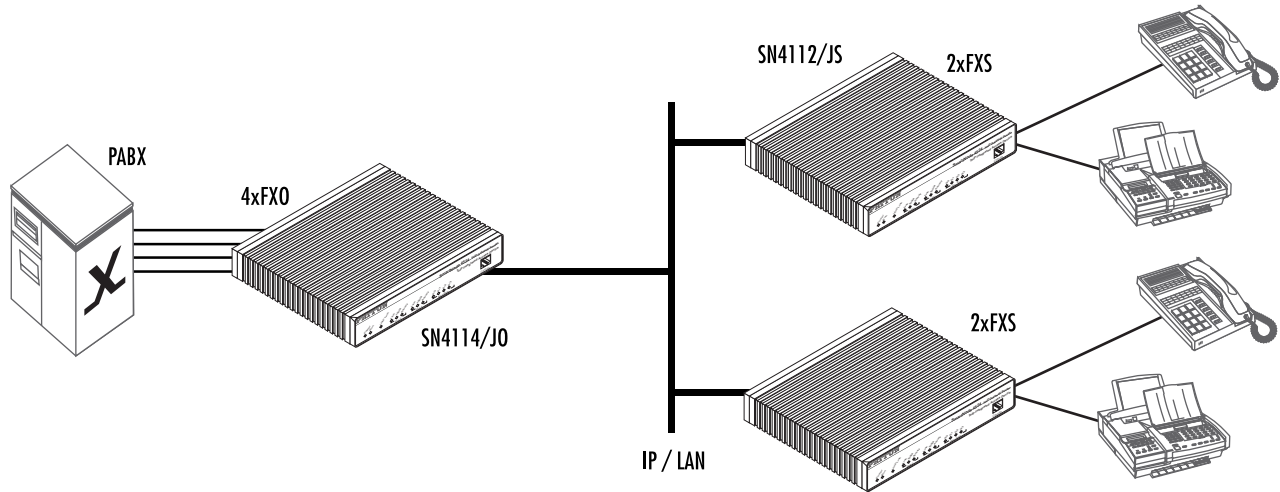

Figure 9. Analog line extension

Application—ITSP dial-in access

An ITSP can use the SmartNode FXO gateways as dial-in access points to his Internet telephony services (see figure 10). A user calls a local number, the FXO SmartNode picks up the call and uses a second dial-tone to dial the remote number. The system can be enhanced with a central call control server providing IVR announcements, PIN checking, and accounting for the calls.

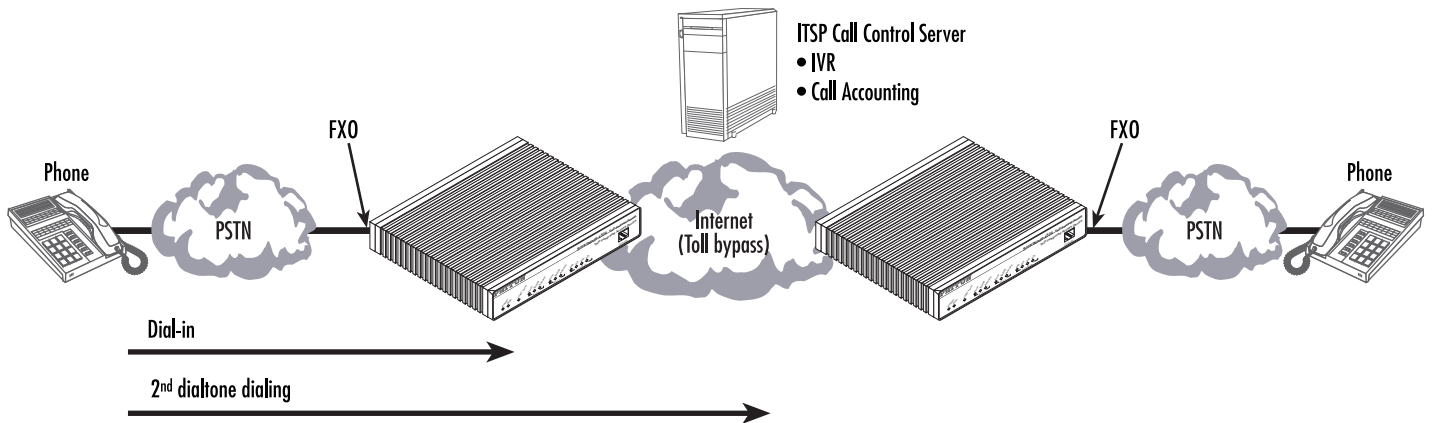

Figure 10. ITSP dial-in access

Application—Private line automatic ringdown (PLAR)

A private hot-line can be created by using two FXS models back-to-back (see figure 11). These can be found in use as courtesy phones at ATM’s, information kiosks, and emergency assistance pedestals. In this application, when one handset is picked-up, the remote handset immediately begins ringing. When the remote handset is picked-up, the speech path is completed. The end-to-end link supports voice, fax Gr.3 (2.4–14.4 kbps) with T.38 or fax- and modem bypass using a G.711 codec.

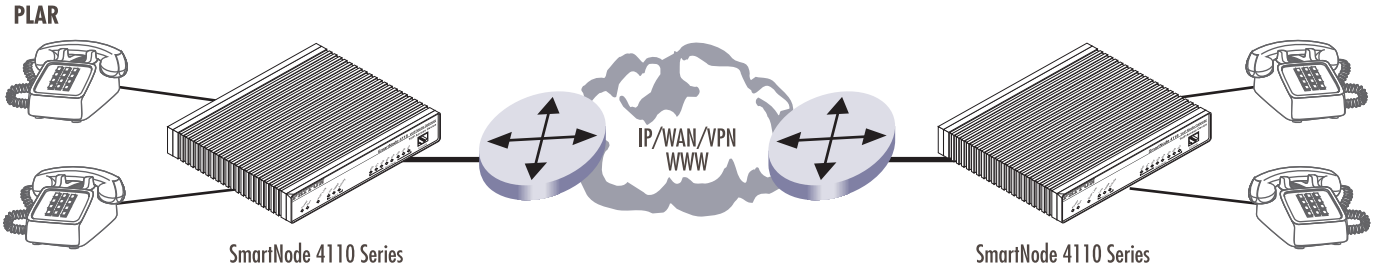

Figure 11. FXS to FXS Hotline

Application—Enterprise campus BRI to FXS telephony extension

In combination with the Patton SmartNode 1000 and 2000 Series models the FXS gateways provide ISDN BRI to FXS extensions over IP (see figure 12).

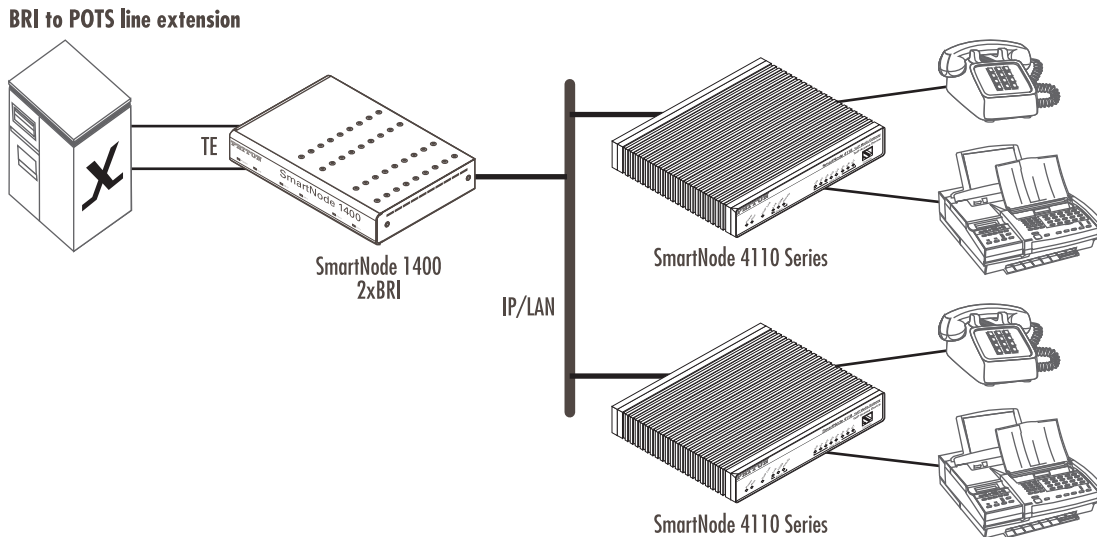

Figure 12. BRI to FXS extension

Application—PBX toll bypass gateway

The gateways can be used to provide toll bypass over an IP WAN (see figure 13). The call routing in this case is provided by the PBX systems. A call routed to the FXS gateway can be relayed on a port-to-port basis or depending on the dialed-number to the remote gateway.

Note With the use of FXS ports, extension dialing on the secondary side must be done by using two-stage dialing (DTMF relay) or a call attendant. DID is not available when using a SmartNode FXS port connected to a PBX FXO port.

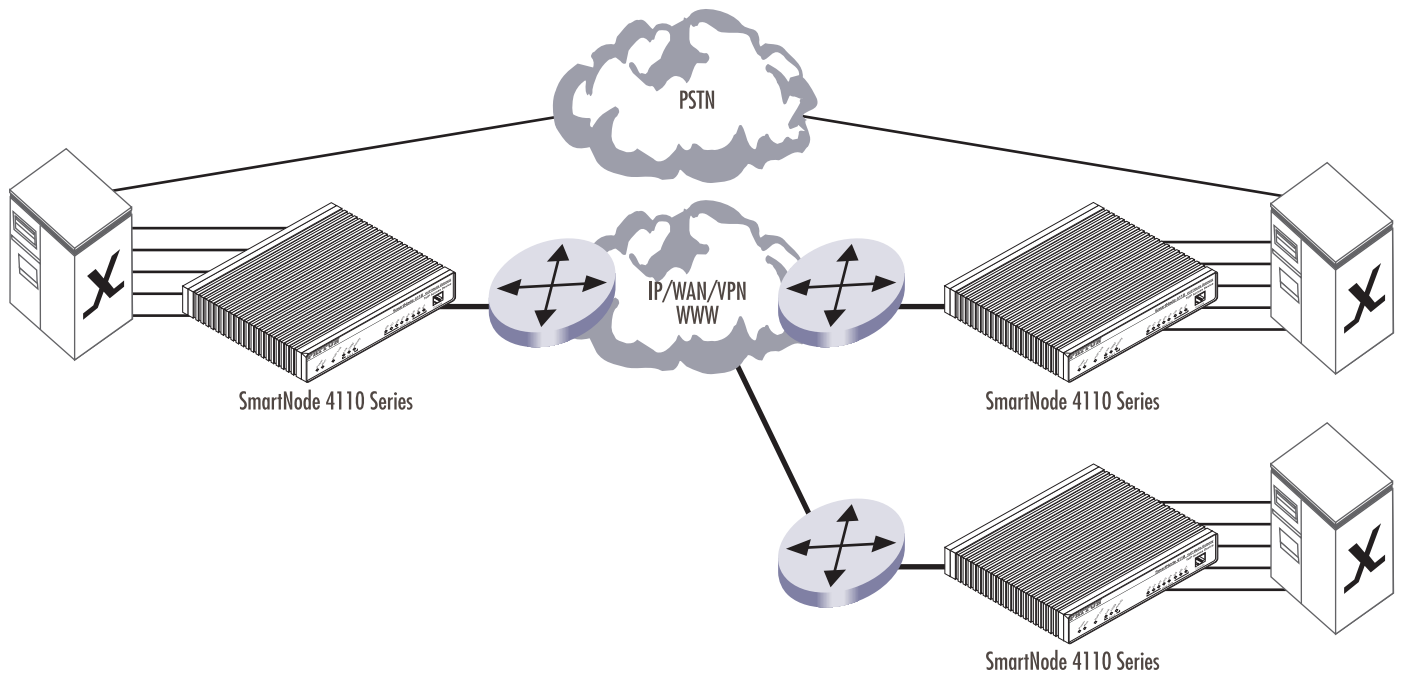

Figure 13. Toll bypass

Applications for SmartNode 4520 Series

SmartNode 4520 Series devices have dual 10/100Base-T Ethernet ports. The two Ethernet ports provide full featured IP routing between LAN and WAN plus Ethernet and IP layer QoS services. Voice prioritization and traffic management avoid network congestion and provide optimal voice quality. With these additional features the SmartNode 4520 series can add Internet access and data networking to any of the SmartNode 4110 Series applications described previously. The following sections show some typical combined voice-data applications.

Application—SOHO off-premise extension

For a SOHO/telecommuter, the SmartNode 4520 Series router can provide an off-premise extension to the corporate network (see figure 14). Along with the analog line extension features, the SmartNode provides Internet access and VPN connectivity to the main office. In this configuration, the remote user will appear to be local and can take advantage of services available to local telephony and LAN users (such as file-server access, station-to-station dialing, outside trunk access, and voice mail). Additionally, the home user can take advantage of corporate dialing rates.

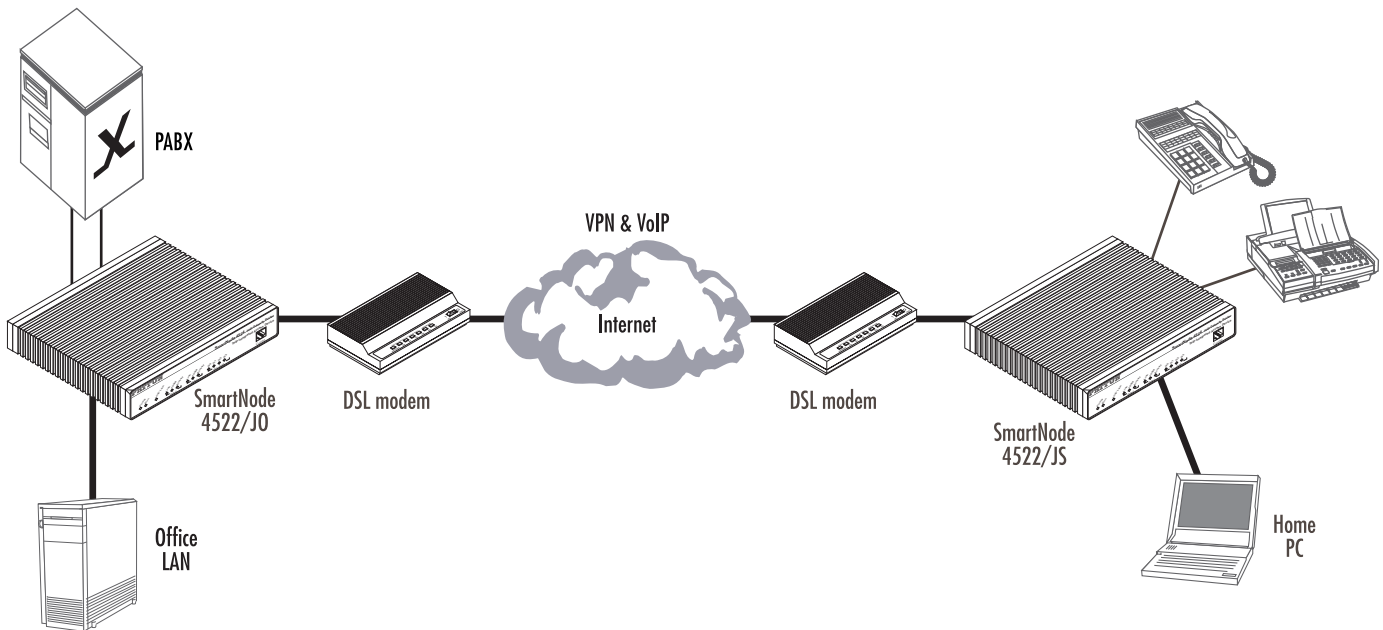

Figure 14. Home office networking

Application—Single-phone PSTN and VoIP access

The SmartNode 4520 Series with a combination of FXS and FXO ports can be used to make and receive calls via PSTN and Internet calling services over the same telephone handset (see figure 15). Using individually configurable routing tables, an outbound call can be directed to the local PSTN connection or to an Internet telephony service provider (ISTP). Inbound calls from the Internet and the PSTN can ring the same phone.

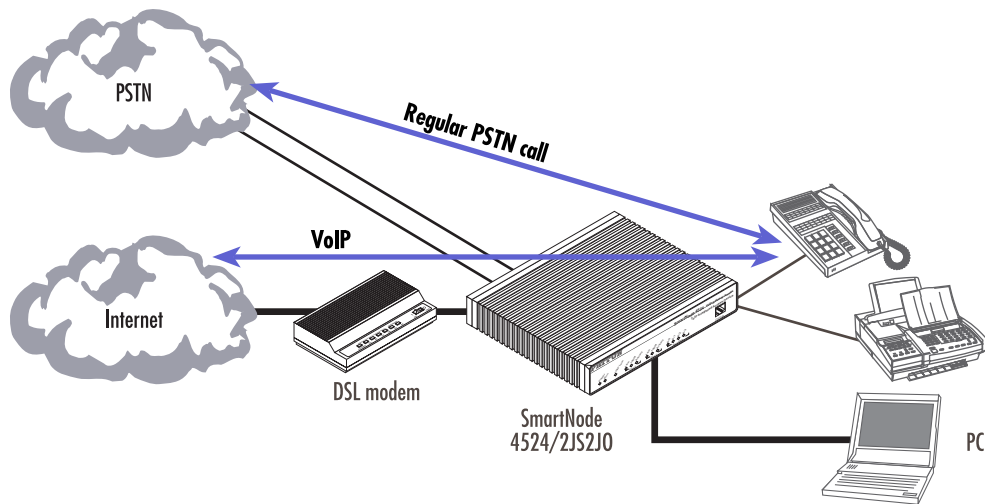

Figure 15. Single-phone access

Chapter 3 **Hardware installation**

Chapter contents

Planning the installation	35
Installation checklist	36
Site log	37
Network information	37
Network Diagram	37
IP related information	37
Software tools	37
Power source	37
Location and mounting requirements	38
Installing the gateway router.....	38
Mounting the gateway router	38
Connecting cables	38
Installing an interface cable on the router's FXS and FXO interface ports	39
Installing the Ethernet cable	41
Connecting to external power source	43

Planning the installation

Before you start the actual installation, it is strongly recommended that you gather all the information needed to install and setup the device. See [table 4](#) for an example of what pre-installment checks you might need to carry out. Having carried out the pre-installation checks enables you to install and set up your gateway router into an existing infrastructure with confidence.



CAUTION

The mains outlet that is utilized to power the equipment must be within 1 foot (3 meters) of the device and shall be easily accessible.

Note When setting up your gateway router consider cable length limitations, and potential electromagnetic interference (EMI) as defined by the applicable local and international regulations. Ensure that your site is properly prepared before beginning installation.

Before installing the gateway router device, the following tasks should be completed:

- **Create a network diagram** (see section “[Network information](#)” on page 37)
- **Gather IP related information** (see section “[IP related information](#)” on page 37 for more information)
- **Install the hardware and software needed to configure the SmartNode.** (See section “[Software tools](#)” on page 37)
- **Verify power source reliability** (see section “[Power source](#)” on page 37).

When you finish preparing for gateway router installation, go to section “[Installing the gateway router](#)” on page 38 to install the device.

Installation checklist

The installation checklist (see [table 4](#)) lists the tasks for installing a SmartNode 4520 or 4110 Series router. Make a copy of this checklist and mark the entries as you complete each task. For each SmartNode 4520 or 4110 Series router, include a copy of the completed checklist in your site log.

Table 4. Installation checklist

Task	Verified by	Date
Network information available & recorded in site log		
Environmental specifications verified		
Site power voltages verified		
Installation site pre-power check completed		
Required tools available		
Additional equipment available		
All printed documents available		
SmartWare release & build number verified		
Rack, desktop, or wall mounting of chassis completed		
Initial electrical connections established		
ASCII terminal attached to console port		
Cable length limits verified		
Initial configuration performed		
Initial operation verified		

Site log

Patton recommends that you maintain a site log to record all actions relevant to the system, if you do not already keep such a log. Site log entries should include information such as listed in [table 5](#).

Table 5. Sample site log entries

Entry	Description
Installation	Make a copy of the installation checklist and insert it into the site log
Upgrades and maintenance	Use the site log to record ongoing maintenance and expansion history
Configuration changes	Record all changes and the reasons for them
Maintenance	Schedules, requirements, and procedures performed
Comments	Notes, and problems
Software	Changes and updates to SmartWare software

Network information

Network connection considerations that you should take into account for planning are provided for several types of network interfaces are described in the following sections.

Network Diagram

Draw a network overview diagram that displays all neighboring IP nodes, connected elements and telephony components.

IP related information

Before you can set up the basic IP connectivity for your SmartNode 4000 series you should have the following information:

- IP addresses used for Ethernet LAN and WAN ports
- Subnet mask used for Ethernet LAN and WAN ports
- IP addresses of central H.323 Gatekeeper (if used)
- IP addresses of central PSTN Gateway for H.323 and/or ISoIP based calls
- IP addresses of central TFTP Server used for configuration upload and download

Software tools

You will need a PC (or equivalent) with a VT-100 emulation program (e.g. HyperTerminal) to configure the software on your SmartNode router.

Power source

If you suspect that your AC power is not reliable, for example if room lights flicker often or there is machinery with large motors nearby, have a qualified professional test the power. Install a power conditioner if necessary.

Location and mounting requirements

The SmartNode router is intended to be placed on a desktop or similar sturdy, flat surface that offers easy access to the cables. Allow sufficient space at the rear of the chassis for cable connections. Additionally, you should consider the need to access the unit for future upgrades and maintenance.

Installing the gateway router

SmartNode gateway router installation consists of the following:

- Placing the device at the desired installation location (see section “Mounting the gateway router” on page 38)
- Installing the interface and power cables (see section “Connecting cables” on page 38)

When you finish installing the SmartNode, go to chapter 4, “Getting started with the SmartNode” on page 45.

Mounting the gateway router

Place the router on a desktop or similar sturdy, flat surface that offers easy access to the cables. The router should be installed in a dry environment with sufficient space to allow air circulation for cooling.

Note For proper ventilation, leave at least 2 inches (5 cm) to the left, right, front, and rear of the SmartNode gateway router.

Connecting cables



Do not work on the system or connect or disconnect cables during periods of lightning activity.

Installing router cables takes place in the following order:

1. Installing the RJ-11 voice port (FXS) cable or cables (see “Installing an interface cable on the router’s FXS and FXO interface ports”)
2. Installing the 10/100 Ethernet port cable or cables (see “Installing the Ethernet cable” on page 41)
3. Installing the power input (see “Connecting to external power source” on page 43)

Installing an interface cable on the router's FXS and FXO interface ports

The gateway comes with at least two FXS or FXO analog ports—or a combination of FXS and FXO ports—(see figure 16) located on the back of the router. The FXS interfaces are connected to analog devices via cables (see figure 17) terminated with RJ-11 connectors (see figure 19 and table 6 on page 40 for pin-out information). The FXO interface connects the router with analog lines via cables (see figure 18 on page 40) terminated with RJ-11 connectors (see figure 19 and table 6 on page 40 for pin-out information).

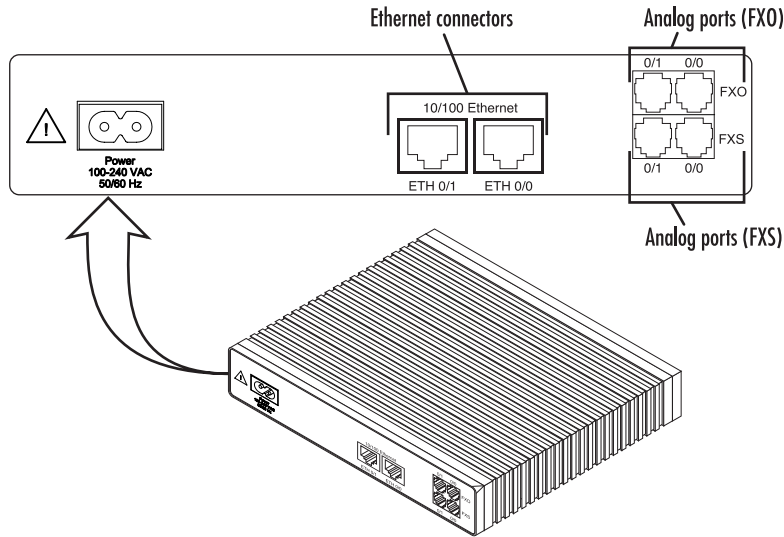

Figure 16. Rear view showing location of Ethernet and FXS connectors (SmartNode 4520 shown)

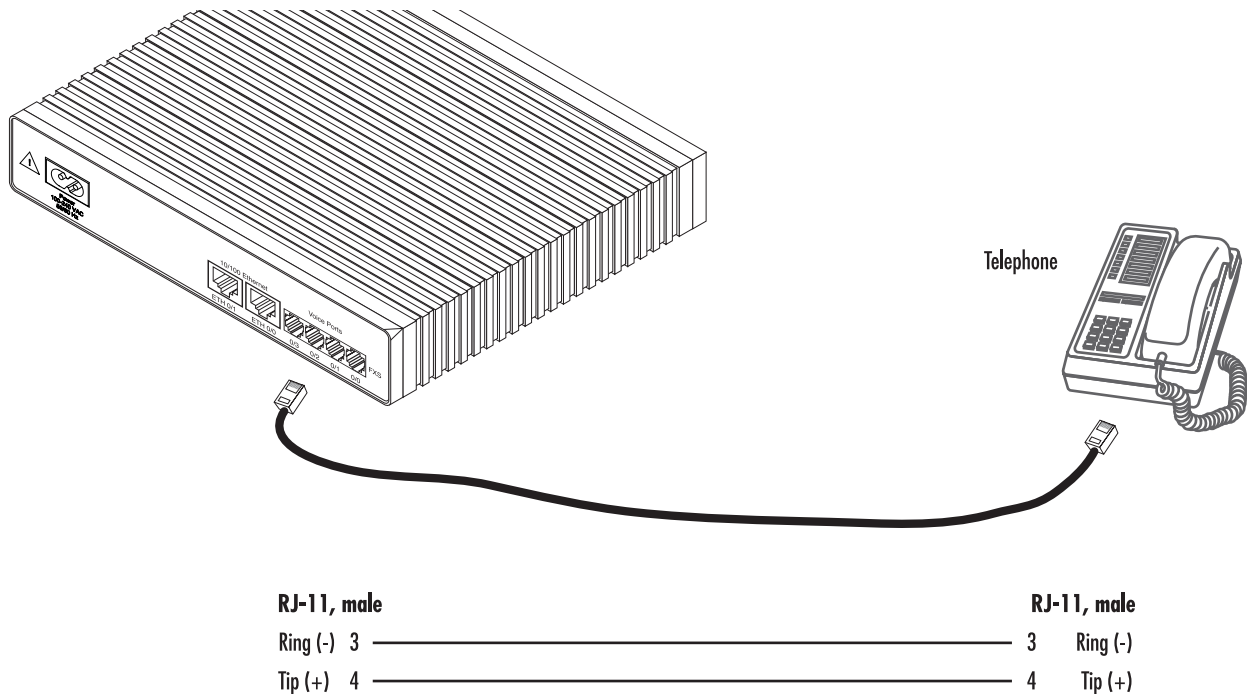

Figure 17. Analog FXS connection

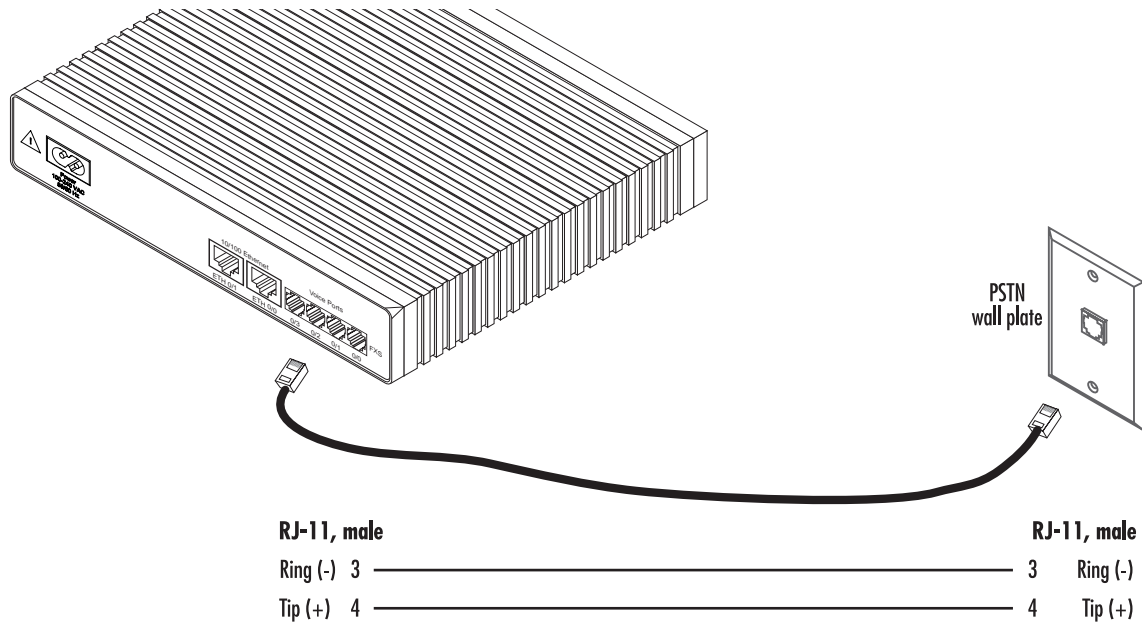

Figure 18. Analog FXO connection

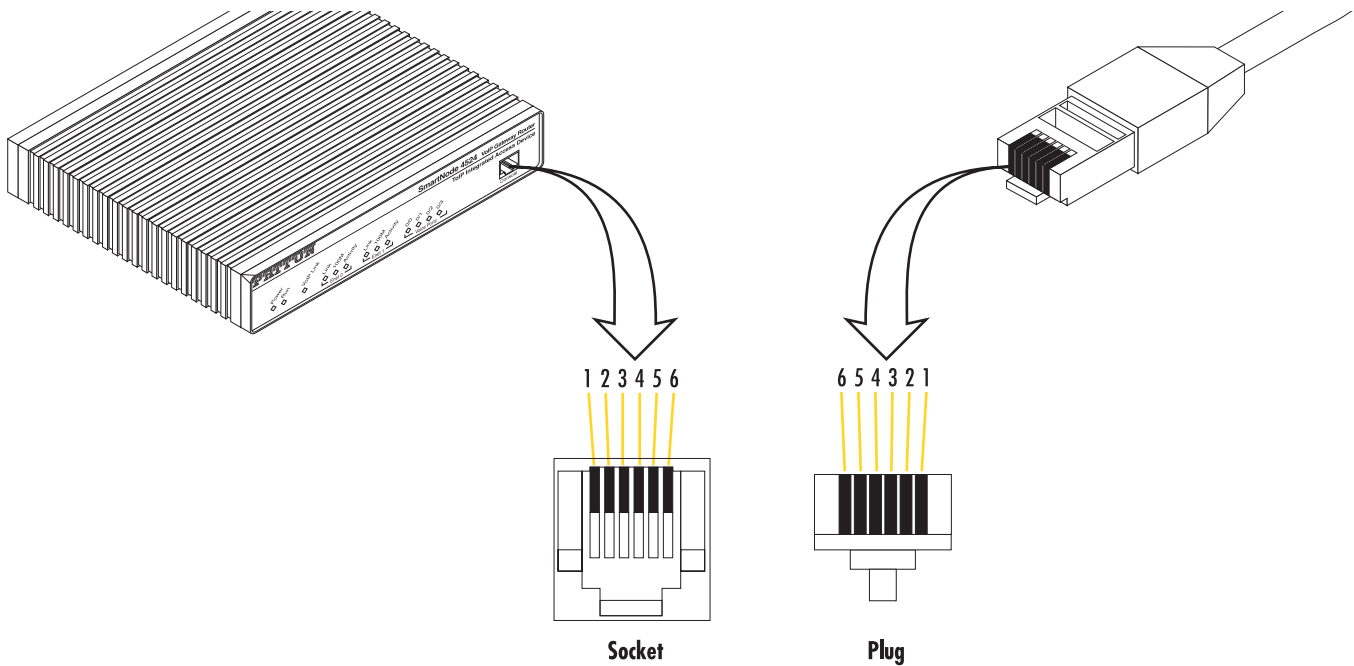

Figure 19. RJ-11 pinout diagram

Table 6. RJ-11 socket

Pin	Signal
3	Ring (-)
4	Tip (+)

Note Unit must not connect directly to telecom network voltage (TNV).

Installing the Ethernet cable

The SmartNode 4520 Series has automatic MDX (auto-cross-over) detection and configuration on the Ethernet ports. Any of the two ports can be connected to a host or hub/switch with a straight-through wired cable (see figure 20 on page 41). Ethernet devices (10Base-T or 100Base-T) are connected to the SmartNode's Ethernet ports (see table 7 for port pin-out listing) via a cable terminated with RJ-45 plugs. Because the SmartNode 4110 Series does not have the MDX feature, a cross-over cable is required when connecting SmartNode 4110 Series devices to a host (see figure 21 on page 42).

Table 7. Ethernet 10/100Base-T (RJ-45) port pin-outs (SmartNode 4110 Series)

Pin	Signal
1	TX+
2	TX-
3	RX+
6	RX-

Note Pins not listed are not used.

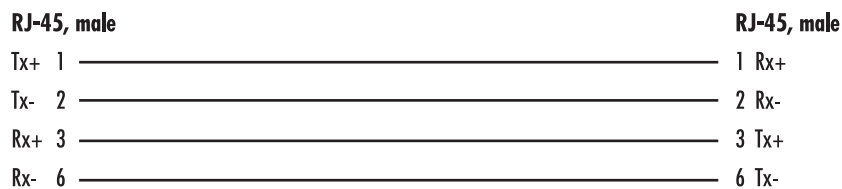
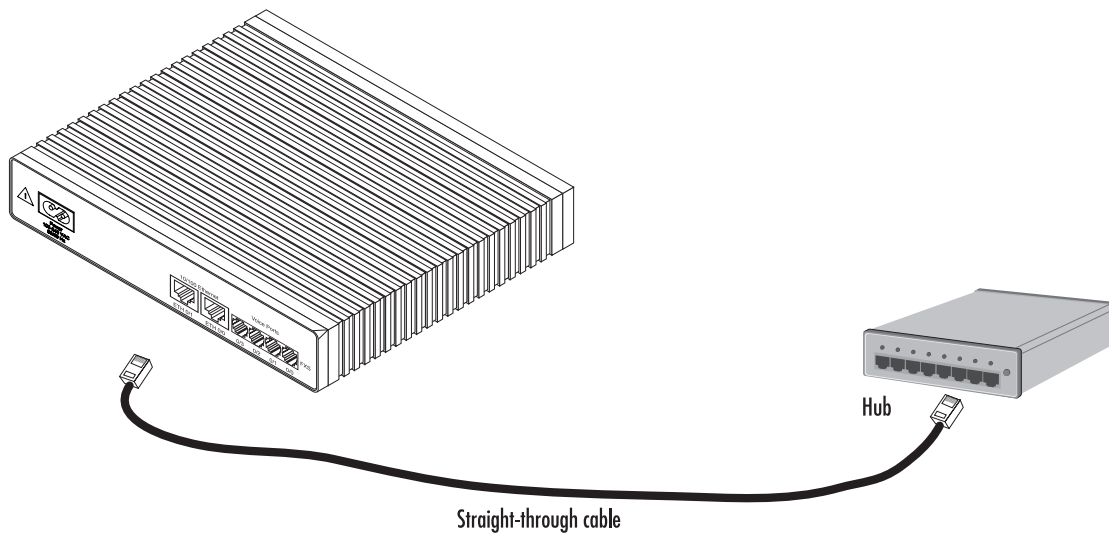

Figure 20. Connecting a SmartNode 4110 Series device to a hub

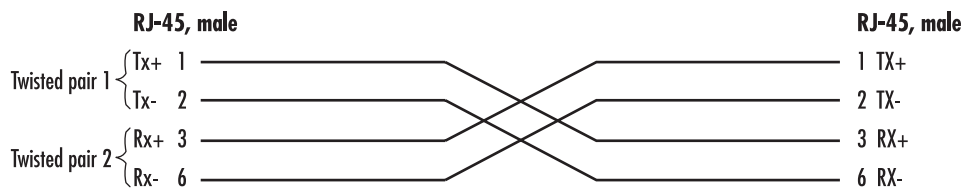
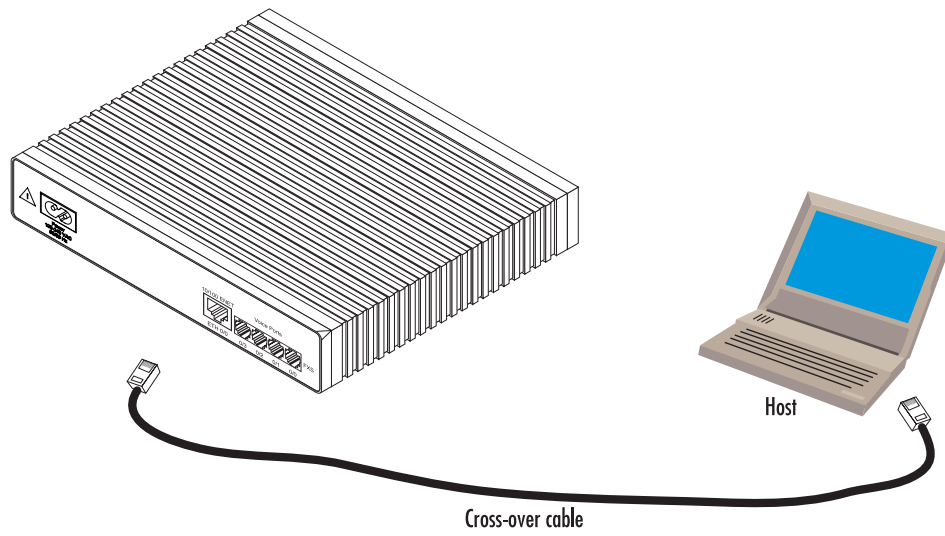

Figure 21. Connecting to a host (cross-over cable required for SmartNode 4110 Series only)

Connecting to external power source

The router comes with an internal or external power supply. This section describes installing the power cord into the router. Do the following:

Note Do not connect the power cord to the power outlet at this time.

1. If your unit is equipped with an internal power supply, go to step 2. Otherwise, insert the barrel type connector end of the AC power cord into the external power supply connector (see figure 22).
2. Insert the female end of the power cord into the internal power supply connector (see figure 22).

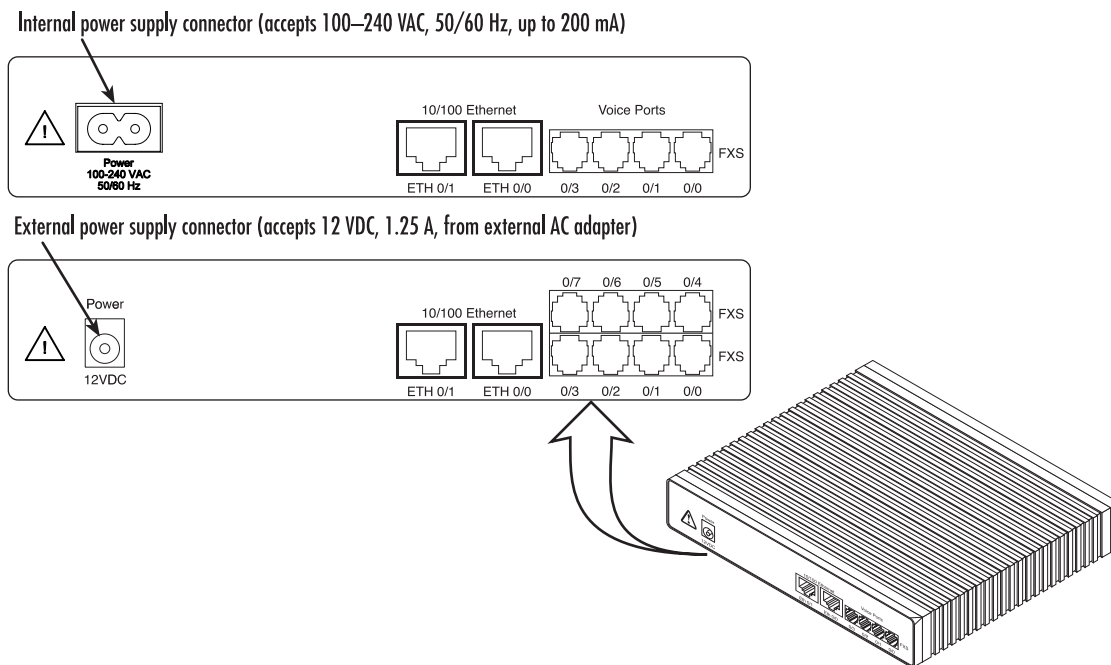

Figure 22. Power connector location on rear panel



The router power supply automatically adjusts to accept an input voltage from 100 to 240 VAC (50/60 Hz).

Verify that the proper voltage is present before plugging the power cord into the receptacle. Failure to do so could result in equipment damage.

3. Verify that the AC power cord included with your router is compatible with local standards. If it is not, refer to “[Contacting Patton for assistance](#)” on page 59 to find out how to replace it with a compatible power cord.
4. Connect the male end of the power cord to an appropriate power outlet.

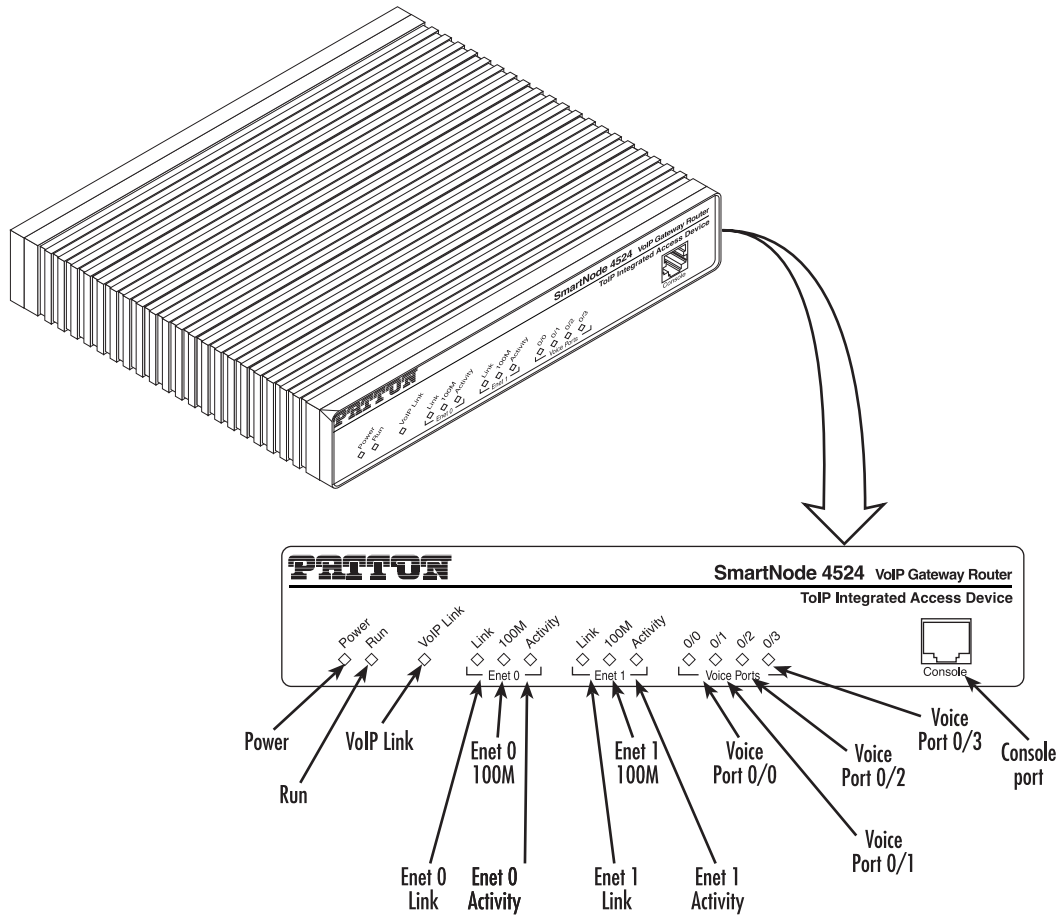

Figure 23. Router front panel LEDs and Console port locations (SmartNode 4524 shown)

5. Verify that the green *Power* LED is lit (see [figure 23](#)).

Congratulations, you have finished installing the SmartNode Gateway Router! Now go to chapter 4, “[Getting started with the SmartNode](#)” on page 45.

Chapter 4 **Getting started with the SmartNode**

Chapter contents

Introduction	47
1. Configure IP address	48
Power connection and default configuration	48
Connect with the serial interface	48
Login	49
Changing the IP address	49
2. Connect the SmartNode to the network	50
3. Load configuration	50
Additional information	51

Introduction

This chapter leads you through the basic steps to set up a new SmartNode and to download a configuration.

Patton SmartNodes can be used for a wide variety of IP-based network applications. To support and ease the configuration of the SmartNodes configuration, templates for the most important applications are available on the Patton server at www.patton.com/voip.

The main steps for setting up a new SmartNode (as of release 2.00 or 2.10) are shown in [figure 24](#).

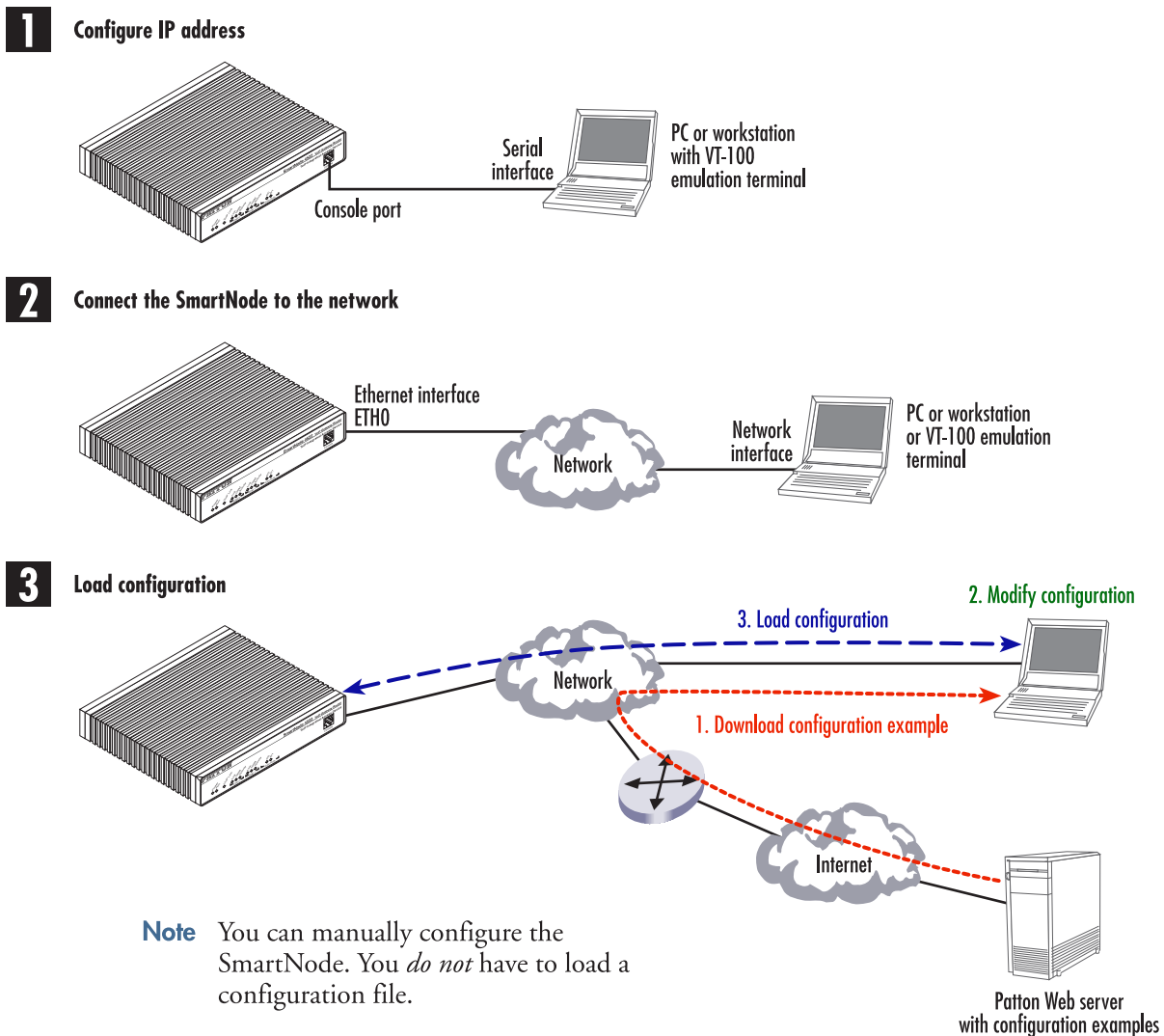

Figure 24. Steps for setting up a new SmartNode

1. Configure IP address

Power connection and default configuration

First the SmartNode must be connected to the mains power supply with the power cable. Wait until the 'Run' LED stops blinking and lights constantly. Now the SmartNode is ready.

The factory default configuration for the Ethernet interface IP addresses and network masks are listed in [table 8](#).

Table 8. Factory default IP address and network mask configuration

	IP Address	Network Mask
Interface Ethernet 0 (ETH0)	DHCP	DHCP
Interface Ethernet 1 (ETH1)	192.168.1.1	255.255.255.0

Both Ethernet interfaces are activated upon power-up.

If these addresses match with those of your network, go to section “2. Connect the SmartNode to the network” on page 50. Otherwise, refer to the following sections to change the addresses and network masks.

Connect with the serial interface

The *Console* port is wired as an EIA-561, RS-232 port. Use the included Model 16F-561 adapter and cable (see [figure 25](#)) between the SmartNode's *Console* port and a PC or workstation's RS-232 serial interface. Activate the terminal emulation program on the PC or workstation that supports the serial interface (e.g. HyperTerm).

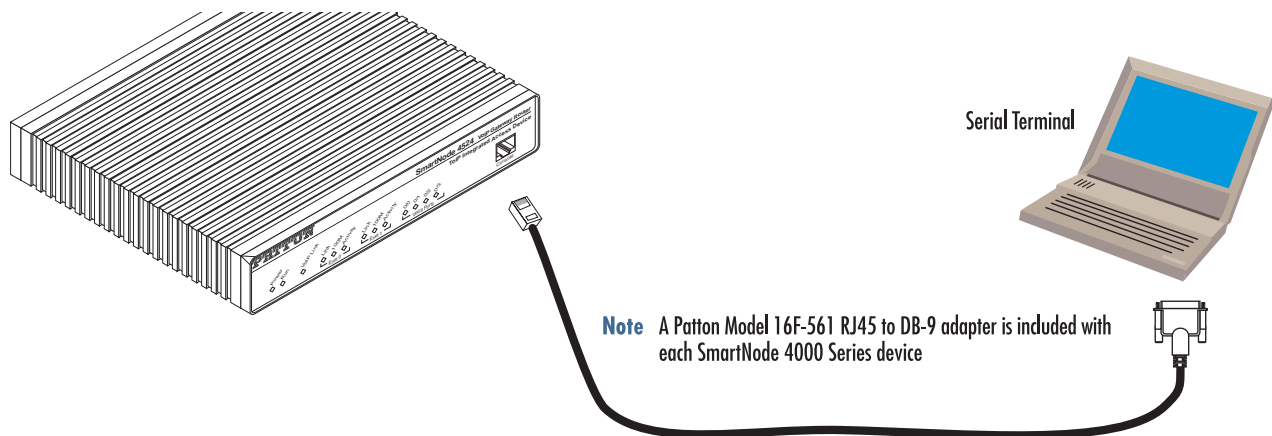

Figure 25. Connecting to the terminal

Terminal emulation program settings:

- 9600 baud
- no parity
- 8 bit
- 1 stop bit
- 1 start bit
- No flow control

Login

Accessing your SmartNode via the local console port (or via a Telnet session) causes the login screen to display. Type the factory default login: *administrator* and leave the password empty. Press the *Enter* key after the password prompt.

```
login:administrator
password: <Enter>
172.16.40.1>
```

After you have successfully logged in you are in the operator execution mode, indicated by > as command line prompt. With the commands *enable* and *configure* you enter the configuration mode.

```
172.16.40.1>enable
172.16.40.1#configure
172.16.40.1(cfg)#
```

Changing the IP address

Select the context IP mode to configure an IP interface.

```
172.16.40.1(cfg)#context ip router
172.16.40.1(ctx-ip)[router]#
```

Now you can set your IP address and network mask for the interface *eth0*. Within this example a class C network (172.16.1.0/24) is assumed. The IP address in this example is set to *172.16.1.99* (you should set this to an unused IP address on your network).

```
172.16.40.1(ctx-ip)[router]#interface eth0
172.16.40.1(if-ip)[eth0]#ipaddress 172.16.1.99 255.255.255.0
2002-10-29T00:09:40 : LOGINFO    : Link down on interface eth0.
2002-10-29T00:09:40 : LOGINFO    : Link up on interface eth0.
172.16.1.99(if-ip)[eth0]#
```

Copy this modified configuration to your new start-up configuration. Upon the next start-up the system will initialize itself using the modified configuration.

```
172.16.1.99(if-ip)[eth0]#copy running-config startup-config
172.16.1.99(if-ip)[eth0]#
```

The SmartNode can now be connected with your network.

2. Connect the SmartNode to the network

Depending whether you connect the SmartNode to a host directly or via a hub or switch either straight-through wired or cross-over cables must be used (see figure 26).

Note The SmartNode 4520 Series is equipped with Auto-MDX Ethernet ports. Use straight-through or cross-over cables for host or hub/switch connections. The SmartNode 4110 will require the proper cable as it does not have the MDX feature.

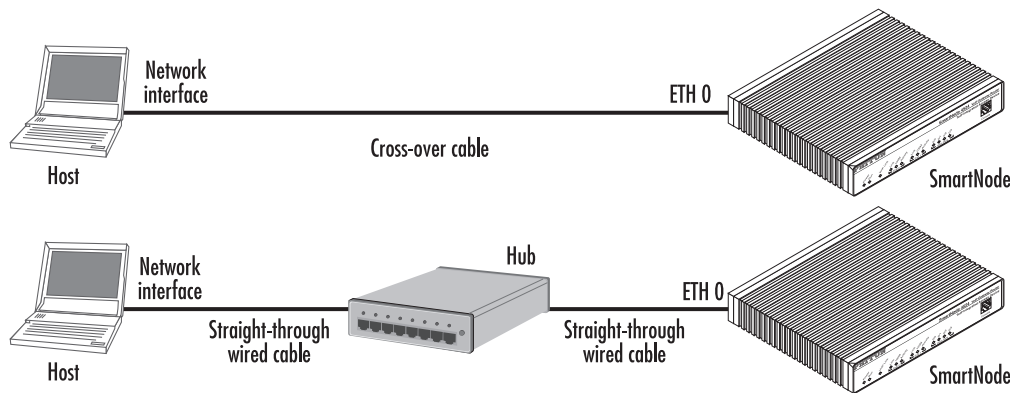

Figure 26. Connecting the SmartNode to the network

You can check the connection with the ping command to another host on the local LAN.

```
172.16.1.99(if-ip)[eth0]#ping <IP Address of the host>
```

Respectively from the host: *ping 172.16.1.99*

Note To ping outside your local LAN, you will need to configure the default gateway.

3. Load configuration

Download a configuration note to your PC from the support page of Patton's Inalp web server (<http://www.inalp.ch/en/support/confignotes/>) that matches your application. Adapt the configuration as described in the configuration note to your network (do not forget to modify the IP address) and copy the modified configuration to a TFTP server. The SmartNode can now load its configuration from this server.

In this example we assume the TFTP server on the host with the IP address 172.16.1.11 and the configuration named *SN.cfg* in the root directory of the TFTP server.

```
172.16.1.99(if-ip)[eth0]#copy tftp://172.16.1.11/SN.cfg startup-config
Download...100%
172.16.1.99(if-ip)[eth0]#
```

After the SmartNode has been rebooted the new start up configuration will be activated.

```
172.16.1.99(if-ip)[eth0]#reload
Running configuration has been changed.
Do you want to copy the 'running-config' to the 'startup-config'?
Press 'yes' to store, 'no' to drop changes : no
```

```
Press 'yes' to restart, 'no' to cancel : yes
The system is going down
```

Additional information

For detailed information about configuring and operating guidance, set up procedures, and troubleshooting, refer to the *Software Configuration Guide* on the enclosed CD-ROM. On the CD you will also find a freeware TFTP server, which is also available from the <http://solarwinds.net/> web site.

Chapter 5 **LEDs status and monitoring**

Chapter contents

Status LEDs.....	55
------------------	----

Status LEDs

This chapter describes SmartNode gateway router front panel LEDs. [Figure 27](#) shows SmartNode 4520 Series LEDs, [figure 28](#) on page 56 shows SmartNode 4110 Series LEDs. LED definitions are listed in [table 9](#) on page 57.

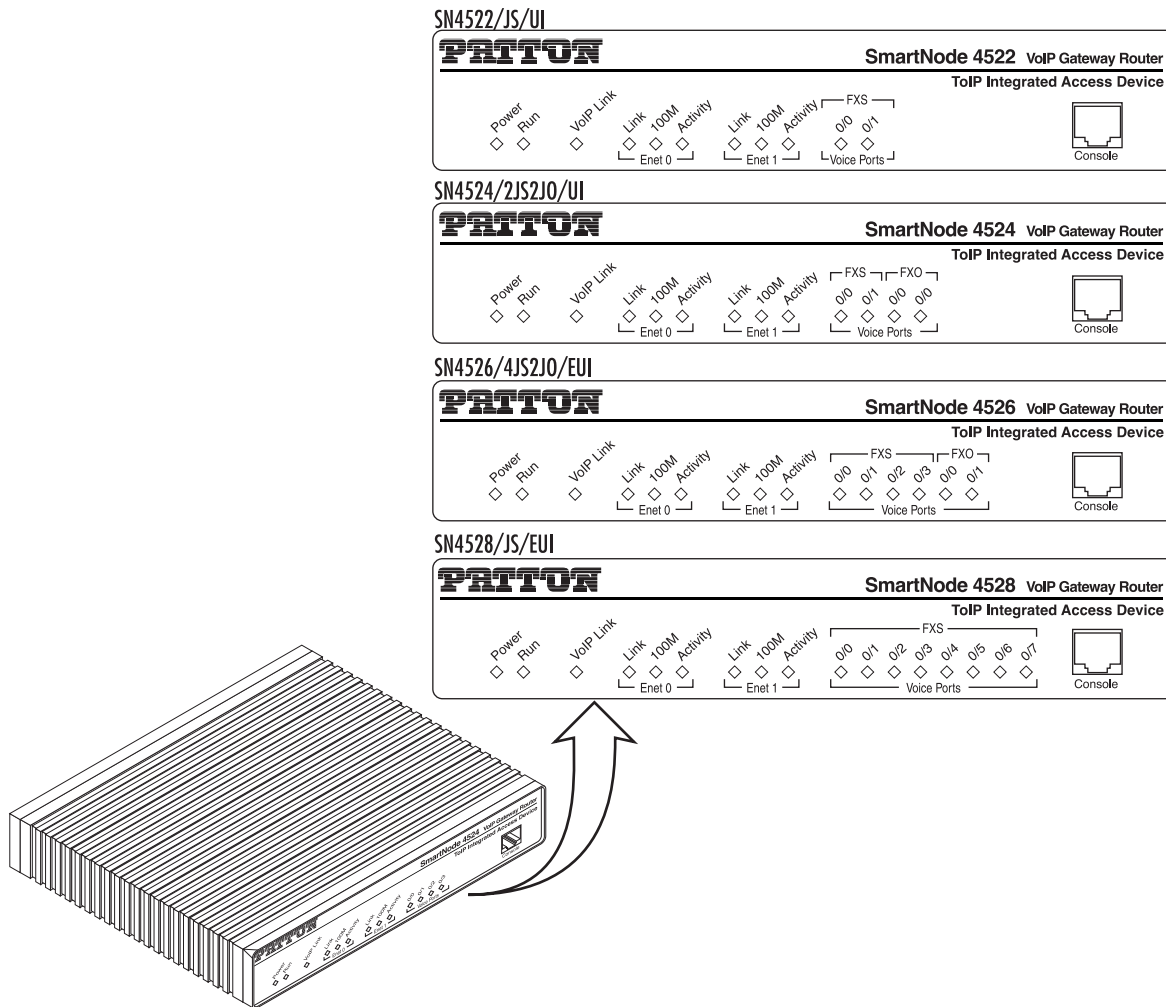

Figure 27. Examples of SN4520 Series front panels

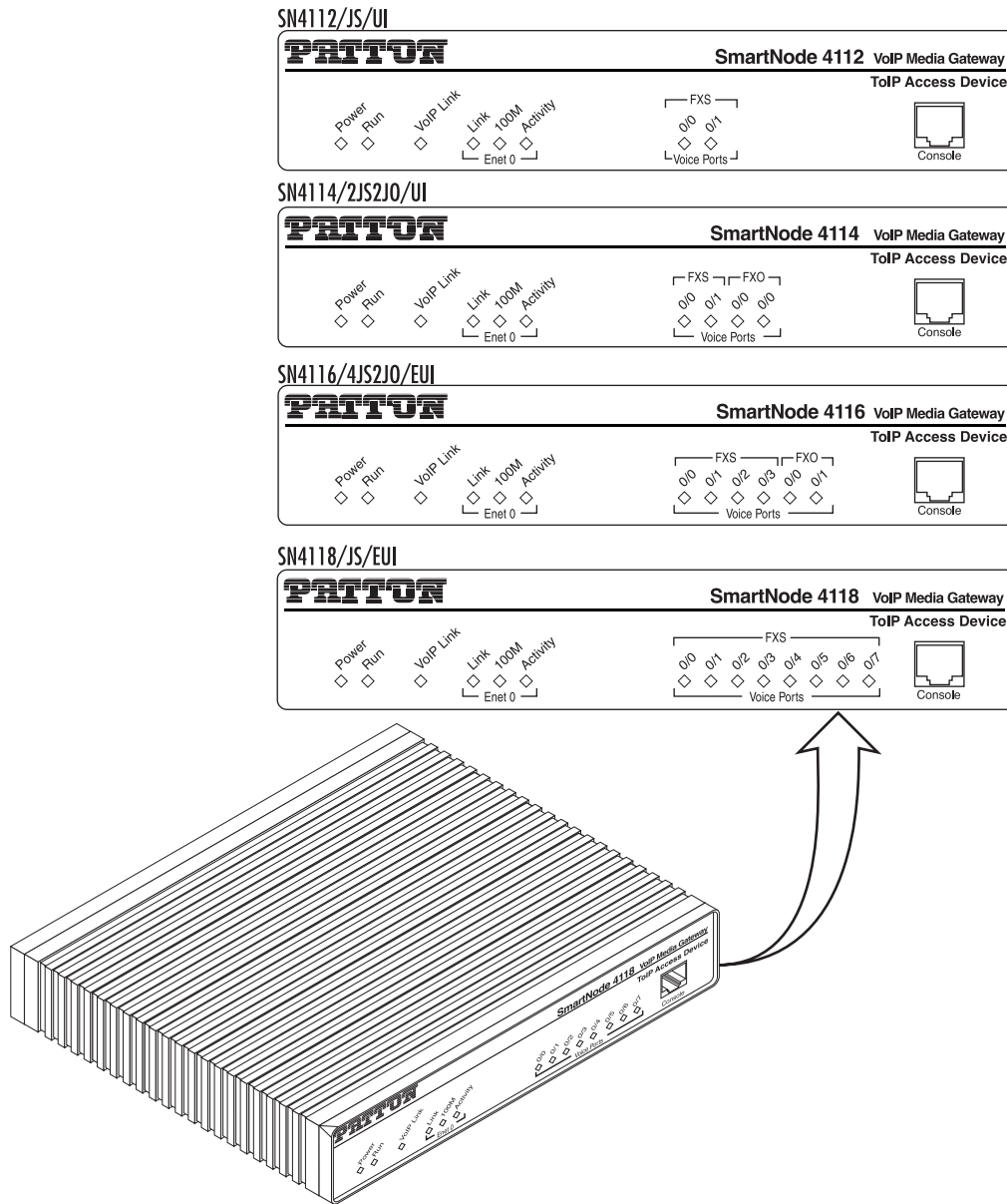

Figure 28. Examples of SN4110 Series front panels

Table 9. SmartNode LED Indications

LED	Description
Note If an error occurs, all LEDs will flash once per second.	
Power	When lit, indicates power is applied. Off indicates no power applied.
Run	When lit, indicates normal operation. Flashes once per second during boot (startup).
VoIP Link	When lit, indicates the gateway is registered on a gatekeeper, media gateway controller, associated to a remote unit, or has an active VoIP connection. Off indicates the unit is not configured or registered and has no active VoIP connection. Flashing green indicates that the unit is attempting or has failed to associate/register
FXS (each port)	Off indicates on-hook condition. Solid green when off-hook. Flashes to follow ring cadence.
FXO (each port)	Off indicates on-hook condition. Solid green when off-hook. Flashes to follow ring cadence.
Ethernet (each port)	<ul style="list-style-type: none"> • Link: Lit when Ethernet link is up. • 100M: On when 100-Mbps Ethernet is selected. • Activity: Flashes when data is received or transmitted from the unit to the LAN.

Chapter 6 **Contacting Patton for assistance**

Chapter contents

- Introduction61
- Contact information61
- Warranty Service and Returned Merchandise Authorizations (RMAs)61
 - Warranty coverage61
 - Out-of-warranty service61
 - Returns for credit61
 - Return for credit policy62
- RMA numbers62
 - Shipping instructions62

Introduction

This chapter contains the following information:

- “Contact information”—describes how to contact Patton technical support for assistance.
- “Warranty Service and Returned Merchandise Authorizations (RMAs)” —contains information about the RAS warranty and obtaining a return merchandise authorization (RMA).

Contact information

Patton Electronics offers a wide array of free technical services. If you have questions about any of our other products we recommend you begin your search for answers by using our technical knowledge base. Here, we have gathered together many of the more commonly asked questions and compiled them into a searchable database to help you quickly solve your problems:

- Online support—available at www.patton.com
- E-mail support—e-mail sent to support@patton.com will be answered within 1 business day
- Telephone support—standard telephone support is available five days a week—from 8:00 am to 5:00 pm EST (1300 to 2200 UTC)—by calling +1 (301) 975-1007

Warranty Service and Returned Merchandise Authorizations (RMAs)

Patton Electronics is an ISO-9001 certified manufacturer and our products are carefully tested before shipment. All of our products are backed by a comprehensive warranty program.

Note If you purchased your equipment from a Patton Electronics reseller, ask your reseller how you should proceed with warranty service. It is often more convenient for you to work with your local reseller to obtain a replacement. Patton services our products no matter how you acquired them.

Warranty coverage

Our products are under warranty to be free from defects, and we will, at our option, repair or replace the product should it fail within one year from the first date of shipment. Our warranty is limited to defects in workmanship or materials, and does not cover customer damage, lightning or power surge damage, abuse, or unauthorized modification.

Out-of-warranty service

Patton services what we sell, no matter how you acquired it, including malfunctioning products that are no longer under warranty. Our products have a flat fee for repairs. Units damaged by lightning or other catastrophes may require replacement.

Returns for credit

Customer satisfaction is important to us, therefore any product may be returned with authorization within 30 days from the shipment date for a full credit of the purchase price. If you have ordered the wrong equipment or you are dissatisfied in any way, please contact us to request an RMA number to accept your return. Patton is not responsible for equipment returned without a Return Authorization.

Return for credit policy

- Less than 30 days: No Charge. Your credit will be issued upon receipt and inspection of the equipment.
- 30 to 60 days: We will add a 20% restocking charge (crediting your account with 80% of the purchase price).
- Over 60 days: Products will be accepted for repairs only.

RMA numbers

RMA numbers are required for all product returns. You can obtain an RMA by doing one of the following:

- Completing a request on the RMA Request page in the *Support* section at www.patton.com
- By calling +1 (301) 975-1007 and speaking to a Technical Support Engineer
- By sending an e-mail to returns@patton.com

All returned units must have the RMA number clearly visible on the outside of the shipping container. Please use the original packing material that the device came in or pack the unit securely to avoid damage during shipping.

Shipping instructions

The RMA number should be clearly visible on the address label. Our shipping address is as follows:

Patton Electronics Company

RMA#: xxxx

7622 Rickenbacker Dr.

Gaithersburg, MD 20879-4773 USA

Patton will ship the equipment back to you in the same manner you ship it to us. Patton will pay the return shipping costs.

Appendix A **Specifications**

Chapter contents

DSP.....	65
Voice connectivity	65
Connectivity.....	65
Voice processing (signalling dependent).....	65
Fax and modem support.....	65
Voice signalling	66
Voice routing—session router.....	66
IP services	66
Management	67
Operating environment	67
Operating temperature	67
Operating humidity	67
System	67
Compliance	67
Dimensions	67
Weight and power dissipation	68
Power supply	68
AC version	68
DC version	68

DSP

One or two 4-channel DSPs

Voice connectivity

2-wire Loopstart, RJ-11/12

Short haul loop 1.1 km @3REN

EuroPOTS (ETSI EG201 188)

Programmable AC impedance, feeding, and ring voltage; On-Hook Voltage 29VDC

Caller-ID Type-1/2 FSK and ITU V.23/Bell 202 generation

Connectivity

2 10/100 Full Duplex/Autosensing Ethernet RJ-45

Voice processing (signalling dependent)

Voice codes:

- G.711 A-Law/ μ -Law (64 kbps)
- G.726 (ADPCM 40, 32, 24, 16 kpbs)
- G.723.1 (5.3 or 6.3 kbps)
- G.729ab (8 kbps)
- Transparent pass through

G.168 echo cancellation

8 parallel voice connections

DTMF detection and generation

Carrier tone detection and generation

Silence suppression and comfort noise

Configurable dejitter buffer

Configurable tones (dial, ringing, busy)

Configurable transmit packet length

RTP/RTCP (RFC 1889)

Fax and modem support

G.711 transparent FAX

Fax over IP (FoIP)

T.38 Fax relay (9.6 k, 14.4 k)

Voice signalling

H.323v4

- RAS, H.225, H.245
- Fast-connect, early H.245
- Gatekeeper autodiscovery
- Alias registration
- Overlap sending
- Empty capability set (call transfer, hold)
- H.323v1 call transfer, hold

ISDN over IP (ISoIP)

- H.323 GW and GK compatible
- H.323 Annex M3
- ISDN/Q-SIG feature tunneling
- ISDN speech, audio and data (Fax Gr 4, UDI 64, RDI 64)

Voice routing—session router

Local switching; Interface huntgroups

Routing Criteria

- Interface
- Calling/called party number
- Time of day, day of week, date
- ISDN bearer capability

Number manipulation functions

- Replace numbers; Add/remove digits
- Multiple remote gateways; PLAR

IP services

IPv4 router; RIPv1, v2 (RFC 1058 and 2453)

Programmable static routes

ICMP redirect (RFC 792); Packet fragmentation

DiffServe/ToS set or queue per header bits

Pocket Policing discards excess traffic

802.1p VLAN tagging

IPSEC AH & ESP Modes

Manual Key; IKE optional

AES/DES/3DES Encryption

Management

Industry standard CLI with local console (CRJ-45, RS-232) and remote Telnet access

TFTP configuration & firmware loading

SNMP v1 agent (MIB II and private MIB)

Built-in diagnostic tools (trace, debug)

Java™ Applet; HPOV Integration with NNM

Operating environment

Operating temperature

32–104°F (0–40°C)

Operating humidity

5–80% (non condensing)

System

CPU Motorola MPC859 operating at 50 MHz

Memory:

- 32 Mbytes SDRAM
- 4 Mbytes Flash

Compliance

EMC compliance: EN55022 and EN55024

Safety compliance: EN60950 and IEC60950

CE compliance

FCC Part 15 Class A

Dimensions

7.3W x 1.6H x 6.1D in. (18.5H x 4.1W x 15.5D cm)

Weight and power dissipation

See table 10.

Table 10. SmartNode weight and maximum power specifications

SmartNode model	Weight	Maximum power dissipation
SN4112/SN4522	30.5 oz/500 g	6W
SN4114/SN4524	30.5 oz/500 g	8W
SN4116/SN4526	24.4 oz/400 g ^a	12W
SN4118/SN4528	24.4 oz/400 g ^a	15W

a. Excluding external power supply

Power supply

AC version

Internal power supply 100–240 VAC, 50/60 Hz, 200 mA

DC version

12 VDC, 1.25 A

Note Power is to be provided by an agency-approved external SELV source which provides reinforced insulation from the AC mains power and where the DC connector is the disconnect device. The source must have a rating of 12 VDC, 1.25 A.

Appendix B **Cabling**

Chapter contents

Introduction	71
Serial console	71
Ethernet 10Base-T and 100Base-T	72
Analog FXS	73
Analog FXO	74

Introduction

This section provides information on the cables used to connect the SmartNode and the interface cards to the existing network infrastructure and to third party products.

Serial console

The SmartNode can be connected to a serial terminal over its serial console port, as depicted in [figure 29](#).

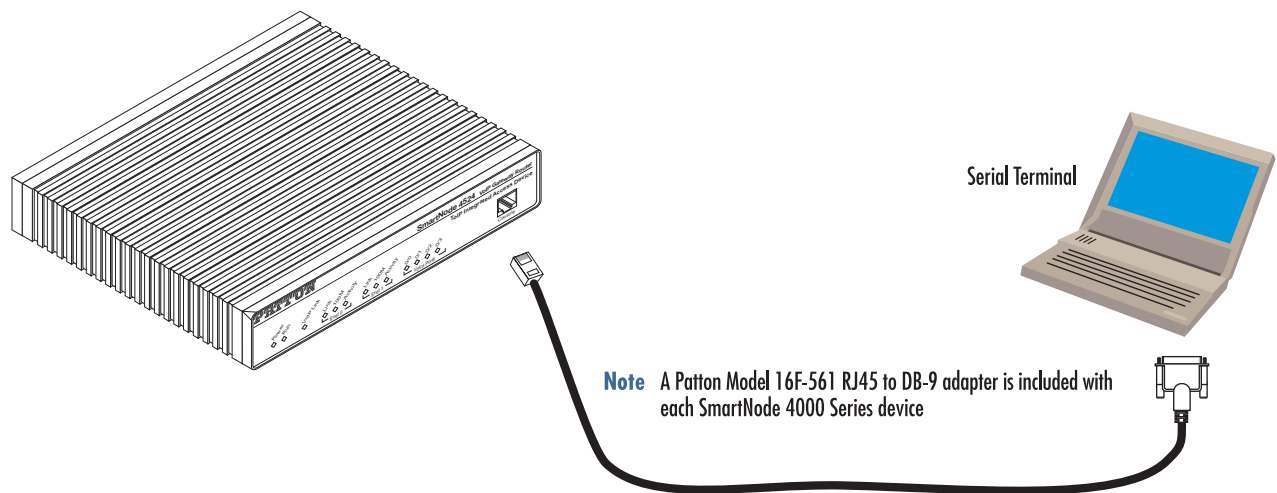

Figure 29. Connecting a serial terminal

Note See section “[Console port](#)” on page 77 for console port pin-outs.

Ethernet 10Base-T and 100Base-T

Ethernet devices (10Base-T/100Base-T) are connected to the SmartNode over a cable with RJ-45 plugs. Use a cross-over cable to a host, or a straight cable to a hub. See [figure 30](#) (host) and [figure 31](#) on page 73 (hub) for the different connections.

Note The SmartNode 4520 Series is equipped with Auto-MDX Ethernet ports. Use straight-through wired cables for host or hub/switch connections

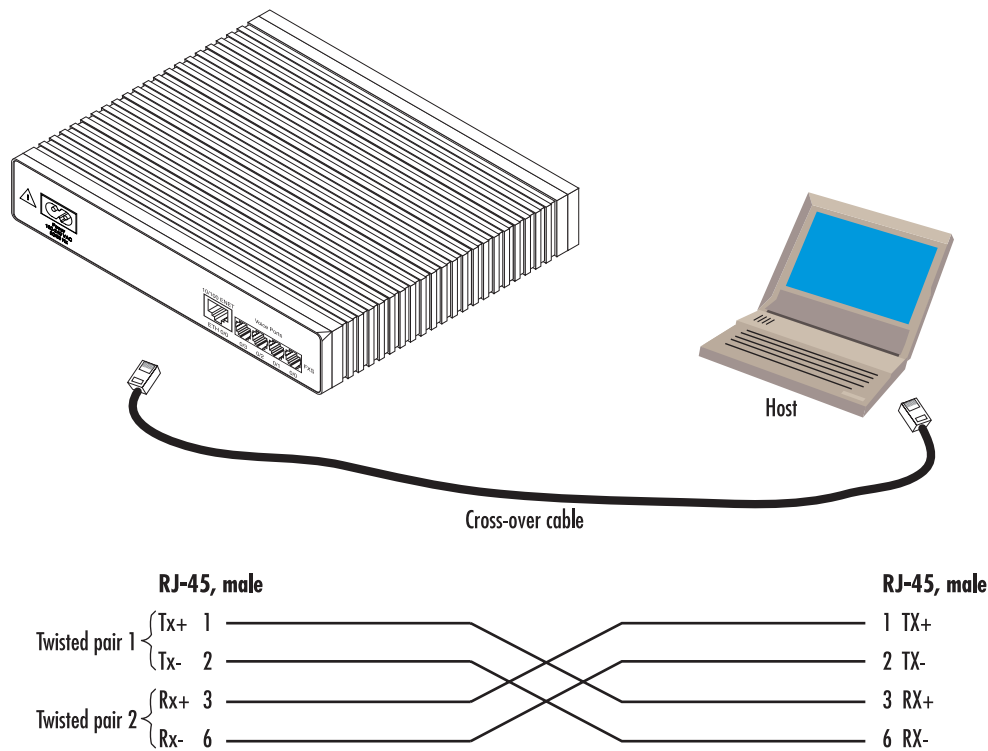

Figure 30. Ethernet cross-over

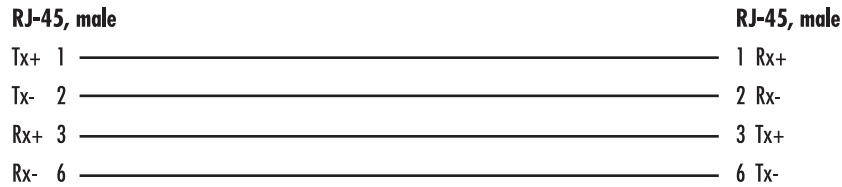
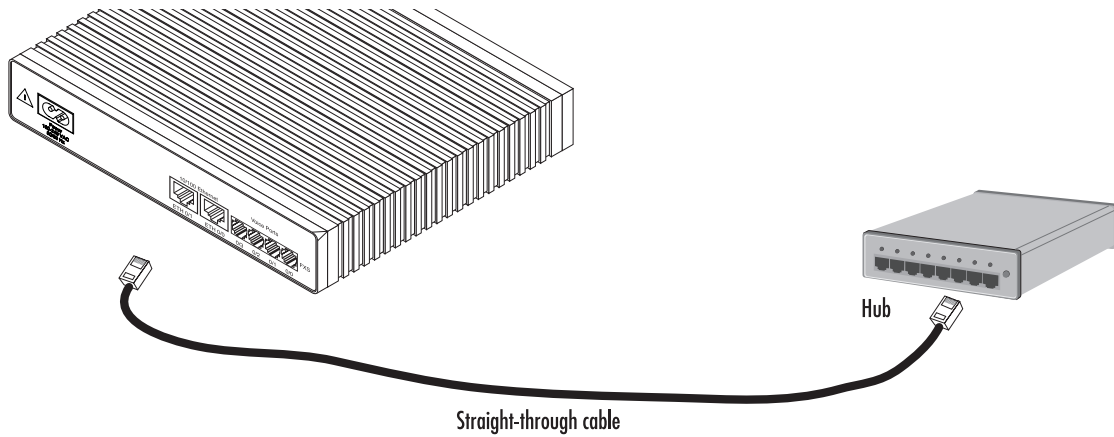

Figure 31. Ethernet straight-through

Analog FXS

Applicable to SmartNodes equipped with FXS ports. The FXS ports are connected to analog terminals (phones, fax machines, answering machines) via cables terminated with RJ-11 connectors (see section “FXS port” on page 77 for details on port pinouts).

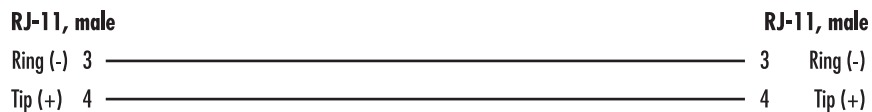
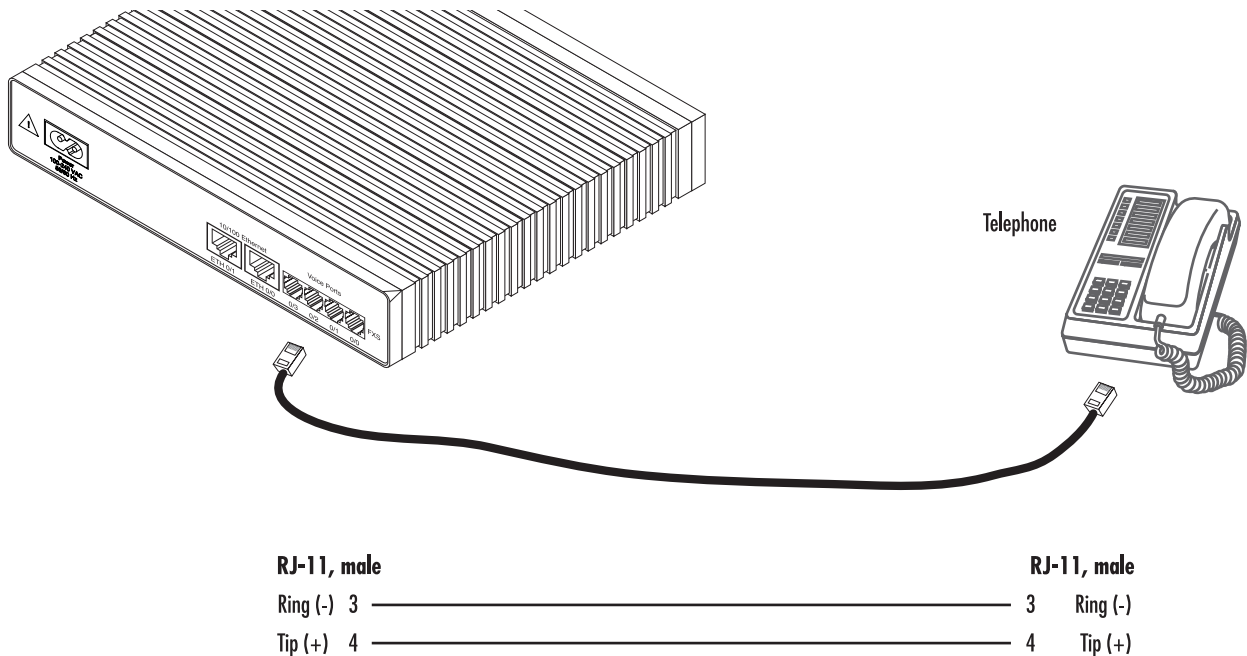

Figure 32. Connecting an FXS device

Analog FXO

Applicable to SmartNodes equipped with FXO ports. The FXO ports are connected to analog phone lines via cables terminated with RJ-11 connectors (see section “FXO port” on page 78 for details on port pinouts).

Note The phone line socket (connector type and pinout) available from the public network vary from country to country. Refer to technical information available from your local operator for additional cabling information.

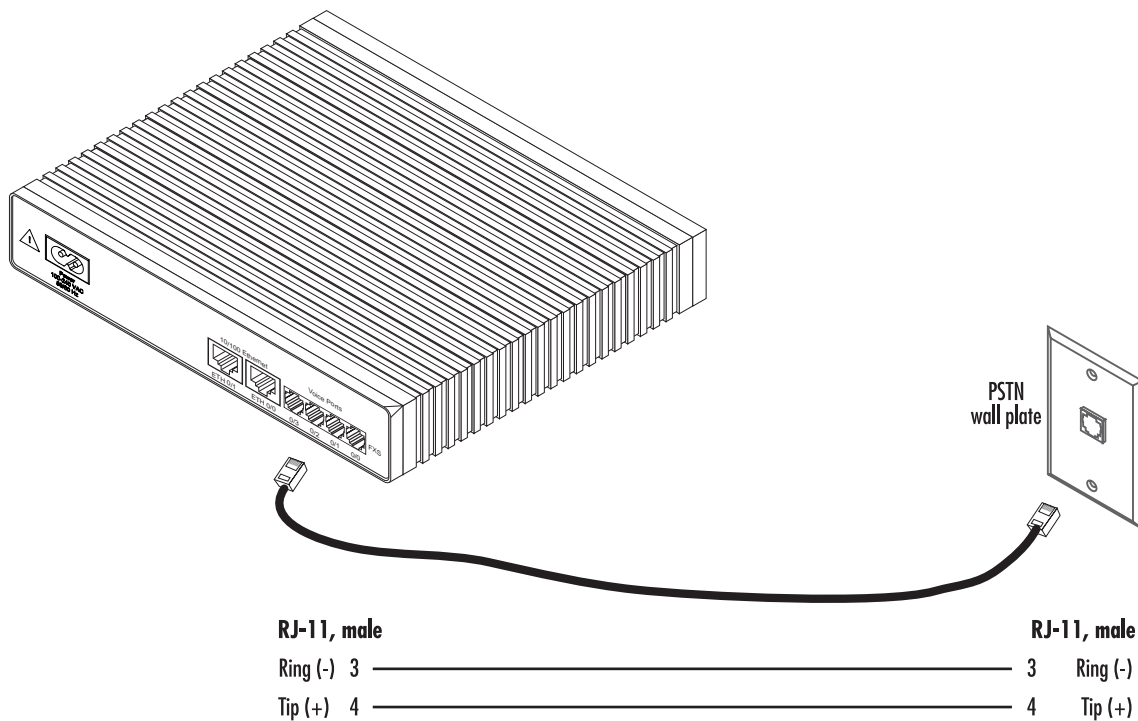

Figure 33. Connecting to an FXO line socket

Appendix C **Port pin-outs**

Chapter contents

Introduction.....	77
Console port.....	77
Ethernet 10Base-T and 100Base-T port.....	77
FXS port.....	77
FXO port	78

Introduction

This section provides pin-out information for the ports of the SmartNode.

Console port

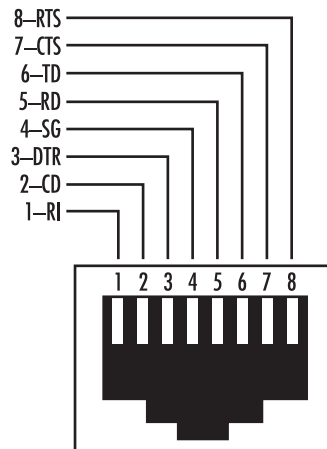

Figure 34. EIA-561 (RJ-45 8-pin) port

Note Pins not listed are not used.

Ethernet 10Base-T and 100Base-T port

Table 11. RJ-45 socket

Pin	Signal
1	TX+
2	TX-
3	RX+
6	RX-

Note Pins not listed are not used.

FXS port

The FXS ports use an RJ-11 connector with 6 positions. The middle two positions 3 and 4 are used according to [table 12](#).

Table 12. RJ-11 socket

Pin	Signal
3	Ring (-)
4	Tip (+)

Note Pins not listed are not used.

FXO port

The FXO ports use an RJ-11 connector with 6 positions. The middle two positions 3 and 4 are used according to [table 13](#).

Table 13. RJ-11 socket

Pin	Signal
3	Ring (-)
4	Tip (+)

Note Pins not listed are not used.

Appendix D **SmartNode 4110 Series factory configuration**

Chapter contents

Introduction	81
--------------------	----

Introduction

The factory configuration settings for SmartNode 4110 Series devices are as follows:

```
#-----#
#
# 4110 Series
# Factory configuration file
#
#-----#

sntp-client
sntp-client server primary 129.132.2.21 port 123 version 4

system
  ic voice 0
    low-bitrate-codec g729

context ip router

  interface eth0
    ipaddress dhcp
    tcp adjust-mss rx mtu
    tcp adjust-mss tx mtu

port ethernet 0 0
  medium auto
  encapsulation ip
  bind interface eth0 router
  no shutdown
```

Appendix E **SmartNode 4520 Series factory configuration**

Chapter contents

Introduction	85
--------------------	----

Introduction

The factory configuration settings for SmartNode 4520 Series devices are as follows:

```
#-----#
#
# 4520 Series
# Factory configuration file
#
#-----#

dns-relay
sntp-client
sntp-client server primary 129.132.2.21 port 123 version 4

system

    ic voice 0
        low-bitrate-codec g729

profile napt NAPT

profile dhcp-server DHCP
network 192.168.1.0 255.255.255.0
include 1 192.168.1.10 192.168.1.99
lease 2 hours
default-router 1 192.168.1.1
domain-name-server 1 192.168.1.1

context ip router

    interface eth0
        ipaddress dhcp
        use profile napt NAPT
        tcp adjust-mss rx mtu
        tcp adjust-mss tx mtu

    interface eth1
        ipaddress 192.168.1.1 255.255.255.0
        tcp adjust-mss rx mtu
        tcp adjust-mss tx mtu

context ip router
    dhcp-server use DHCP

port ethernet 0 0
    medium auto
    encapsulation ip
    bind interface eth0 router
    no shutdown

port ethernet 0 1
    medium auto
    encapsulation ip
    bind interface eth1 router
    no shutdown
```

Appendix F **Installation checklist**

Chapter contents

Introduction.....	89
-------------------	----

Introduction

This appendix lists the tasks for installing a SmartNode 4520 or 4110 Series router (see [table 14](#)) . Make a copy of this checklist and mark the entries as you complete each task. For each SmartNode 4520 or 4110 Series router, include a copy of the completed checklist in your site log.

Table 14. Installation checklist

Task	Verified by	Date
Network information available & recorded in site log		
Environmental specifications verified		
Site power voltages verified		
Installation site pre-power check completed		
Required tools available		
Additional equipment available		
All printed documents available		
SmartWare release & build number verified		
Rack, desktop, or wall mounting of chassis completed		
Initial electrical connections established		
ASCII terminal attached to console port		
Cable length limits verified		
Initial configuration performed		
Initial operation verified		

