



User Guide for the Polycom® VVX™ 1500 Phone

SIP 3.1.2

March, 2009 Edition
1725-16843-001 Rev. A
SIP 3.1.2



Trademark Information

POLYCOM®, the Polycom “Triangles” logo and the names and marks associated with Polycom’s products are trademarks and/or service marks of Polycom, Inc. and are registered and/or common law marks in the United States and various other countries. All other trademarks are property of their respective owners. No portion hereof may be reproduced or transmitted in any form or by any means, for any purpose other than the recipient’s personal use, without the express written permission of Polycom.

Patent Information

The accompanying product is protected by one or more U.S. and foreign patents and/or pending patent applications held by Polycom, Inc.

Disclaimer

Some countries, states, or provinces do not allow the exclusion or limitation of implied warranties or the limitation of incidental or consequential damages for certain products supplied to consumers, or the limitation of liability for personal injury, so the above limitations and exclusions may be limited in their application to you. When the implied warranties are not allowed to be excluded in their entirety, they will be limited to the duration of the applicable written warranty. This warranty gives you specific legal rights which may vary depending on local law.

Copyright Notice

Portions of the software contained in this product are:
Copyright © 1998, 1999, 2000 Thai Open Source Software Center Ltd. and Clark Cooper
Copyright © 1998 by the Massachusetts Institute of Technology
Copyright © 1998-2003 The OpenSSL Project
Copyright © 1995-1998 Eric Young (eay@cryptsoft.com). All rights reserved
Copyright © 1995-2002 Jean-Loup Gailly and Mark Adler
Copyright © 1996-2004, Daniel Stenberg, <daniel@haxx.se>

Permission is hereby granted, free of charge, to any person obtaining a copy of this software and associated documentation files (the “Software”), to deal in the Software without restriction, including without limitation the rights to use, copy, modify, merge, publish, distribute, sublicense, and/or sell copies of the Software, and to permit persons to whom the Software is furnished to do so, subject to the following conditions:

The above copyright notice and this permission notice shall be included in all copies or substantial portions of the Software.

THE SOFTWARE IS PROVIDED “AS IS”, WITHOUT WARRANTY OF ANY KIND, EXPRESS OR IMPLIED, INCLUDING BUT NOT LIMITED TO THE WARRANTIES OF MERCHANTABILITY, FITNESS FOR A PARTICULAR PURPOSE AND NONINFRINGEMENT. IN NO EVENT SHALL THE AUTHORS OR COPYRIGHT HOLDERS BE LIABLE FOR ANY CLAIM, DAMAGES OR OTHER LIABILITY, WHETHER IN AN ACTION OF CONTRACT, TORT OR OTHERWISE, ARISING FROM, OUT OF OR IN CONNECTION WITH THE SOFTWARE OR THE USE OR OTHER DEALINGS IN THE SOFTWARE.

© 2009, Polycom, Inc. All rights reserved.

Polycom Inc.
4750 Willow Road
Pleasanton, CA 94588-2708
USA

No part of this document may be reproduced or transmitted in any form or by any means, electronic or mechanical, for any purpose, without the express written permission of Polycom, Inc. Under the law, reproducing includes translating into another language or format.

As between the parties, Polycom, Inc. retains title to, and ownership of, all proprietary rights with respect to the software contained within its products. The software is protected by United States copyright laws and international treaty provision. Therefore, you must treat the software like any other copyrighted material (e.g. a book or sound recording).

Every effort has been made to ensure that the information in this manual is accurate. Polycom, Inc. is not responsible for printing or clerical errors. Information in this document is subject to change without notice.

About This Guide

Thank you for choosing the Polycom® VVX™ 1500 phone. The phone is a business media phone that combines advanced business telephony, one-touch video, real-time presence, and integrated business applications into one seamless, lifelike communications experience.

The phone provides a powerful, yet flexible IP communications solution, delivering excellent video and voice quality. The high-resolution color graphic display supplies content for call information, multiple languages, directory access, and system status. The phone supports advanced functionality, including multiple call and flexible line appearances, HTTPS secure provisioning, presence, custom ring tones, and local audio and video conferencing.

Some of the key features include:

- Seven inch diagonal color touch screen
- Support for Polycom HD Voice™ technology
- Privacy shutter for the video camera
- Adjustable base, display, and camera angle
- USB port for applications
- Ability to use a Power over Ethernet (PoE) power source
- Support for Electronic Hookswitch (EHS) with select partner headsets

This guide provides everything you need to quickly use your new phone. Be sure to verify with your system administrator that your network is prepared for configuring your phone. As well, be sure to read the [Parts List](#) and [Safety Notices](#) sections in this guide before you set up and use the phone.

Contents

| | |
|--------------------------------------------------------------------------|------------|
| About This Guide | iii |
| 1 Getting Started with Your Phone | 1-1 |
| Parts List | 1-2 |
| Optional Accessories | 1-2 |
| Setting Up Your Phone | 1-3 |
| Adjusting the Stand | 1-3 |
| Attaching Ferrite Clamps | 1-5 |
| Connecting Network and Power Sources | 1-5 |
| Connecting the Handset and Handset Cord | 1-8 |
| Connecting Optional Components | 1-8 |
| Adjusting the Screen | 1-12 |
| Adjusting the Camera | 1-13 |
| Registering the Phone | 1-14 |
| Features of Your Phone | 1-14 |
| Before You Use Your Desktop Phone | 1-18 |
| Touch Screen Components | 1-19 |
| Phone Icons | 1-22 |
| Navigating Menus, Lists, and Fields | 1-24 |
| Entering Data and Editing Fields | 1-27 |
| Obtaining the Best Performance from Video Calls and Conferences | 1-31 |
| Cleaning the Touch Screen | 1-31 |
| 2 Customizing Your Phone | 2-1 |
| Configuring Basic Settings | 2-2 |
| Changing the Language | 2-3 |
| Changing the Appearance of Time and Date | 2-3 |
| Enabling Headset Memory Mode | 2-7 |
| Using Electronic Hookswitch | 2-8 |
| Updating the Background Picture | 2-8 |

| | |
|--------------------------------------------------------------------------------------------|------|
| Setting Up a Screen Saver | 2-9 |
| Stopping and Disabling a Screen Saver | 2-13 |
| Displaying the Pictures that are Stored on Your USB Flash Drive | 2-14 |
| Setting a Picture on Your USB Flash Drive as the Background Picture on Your Phone | 2-16 |
| Changing the Backlight Intensity | 2-17 |
| Updating the Ring Tone | 2-20 |
| Disabling and Stopping Video | 2-23 |
| Updating Video Settings | 2-24 |
| Updating Power Saving Settings | 2-34 |
| Muting the Microphone | 2-40 |
| Adjusting the Volume | 2-41 |
| Using Call Lists | 2-41 |
| Viewing Call Lists | 2-42 |
| Managing Call Lists | 2-42 |
| Managing Contacts | 2-44 |
| Adding Contacts to Your Local Contact Directory | 2-46 |
| Searching for Contacts | 2-54 |
| Updating Contacts in Your Local Contact Directory | 2-56 |
| Deleting Contacts from Your Local Contact Directory | 2-58 |
| Placing Calls to Contacts | 2-59 |
| Managing Incoming Calls | 2-60 |
| Distinguishing Calls | 2-61 |
| Rejecting Calls | 2-61 |
| Diverting Calls | 2-63 |
| System Customizations | 2-64 |
| Supporting Multiple Lines | 2-64 |
| Supporting Multiple Line Keys Per Line | 2-67 |
| Supporting Shared Lines | 2-68 |

3 Using the Basic Features of Your Phone. 3-1

| | |
|--------------------------------------------|------|
| Handling Calls | 3-2 |
| Handling Video Calls | 3-3 |
| Placing Calls | 3-6 |
| Place Calls Using the Handset | 3-8 |
| Placing Calls Using the Speakerphone | 3-8 |
| Placing Calls Using the Headset | 3-9 |
| Placing Calls Using Speed Dial | 3-10 |

| | |
|---------------------------------------------------------|------|
| Answering Calls | 3-12 |
| Ending Calls | 3-15 |
| Redialing Numbers | 3-15 |
| Placing Calls on Hold | 3-16 |
| Hosting Conference Calls | 3-18 |
| Setting Up Conference Calls | 3-19 |
| Holding and Resuming Conference Calls | 3-21 |
| Ending Conference Calls | 3-22 |
| Splitting Conference Calls into Two Calls on Hold | 3-22 |
| Managing Conference Call Participants | 3-22 |
| Handling Video During Conference Calls | 3-25 |
| Transferring Calls | 3-25 |
| Forwarding Calls | 3-28 |
| Forwarding Calls Statically | 3-29 |
| Forwarding Calls Dynamically | 3-33 |
| Enabling Do Not Disturb | 3-33 |
| Multiple Lines and Do Not Disturb | 3-34 |
| Managing Speed Dial Keys | 3-38 |
| Adding Speed Dial Keys | 3-40 |
| Updating Speed Dial Keys | 3-40 |
| Accessing Voice and Video Mail | 3-42 |

4 Using the Advanced Features of Your Phone 4-1

| | |
|----------------------------------------------------------------|------|
| Using Instant Messaging | 4-1 |
| Reading and Managing Instant Messages | 4-2 |
| Sending Instant Messages | 4-3 |
| Using Buddy Lists | 4-6 |
| Updating Your Presence Settings | 4-6 |
| Managing Buddies | 4-8 |
| Monitoring Buddies | 4-13 |
| Integrating With Microsoft Live Communications Server 2005 ... | 4-14 |
| Using the Busy Lamp Field | 4-16 |
| Recording Calls | 4-17 |
| Playing Back Recorded Calls | 4-23 |
| Using the Launch Pad | 4-30 |
| Accessing Launch Pad | 4-30 |
| Enabling My Info Portal | 4-32 |
| Restarting Your Phone | 4-33 |

5 Troubleshooting Your Phone 5-1

Power and Startup 5-2
Controls 5-3
Access to Screens and Systems 5-4
Calling 5-5
Displays 5-6
Audio 5-6
Testing Phone Hardware 5-7

Safety Notices Safety Notices-1

Index. Index-1

End-User License Agreement for Polycom® Software

Getting Started with Your Phone

This chapter provides basic installation instructions and information for obtaining the best performance with the Polycom VVX 1500 phone.

The topics include:

- [Parts List](#) on page 1-2
- [Setting Up Your Phone](#) on page 1-3
- [Registering the Phone](#) on page 1-14
- [Features of Your Phone](#) on page 1-14
- [Before You Use Your Desktop Phone](#) on page 1-18
- [Cleaning the Touch Screen](#) on page 1-31

To customize your phone, see [Customizing Your Phone](#) on page 2-1. To read about the phone's basic features, see [Using the Basic Features of Your Phone](#) on page 3-1. To read about the phone's advanced features, see [Using the Advanced Features of Your Phone](#) on page 4-1.

If you require additional information or assistance with your new phone, contact your system administrator.

Parts List

The following components are included in your Polycom VVX 1500 phone package. Check to ensure that you have received each item. If you are missing any items, contact your system administrator.

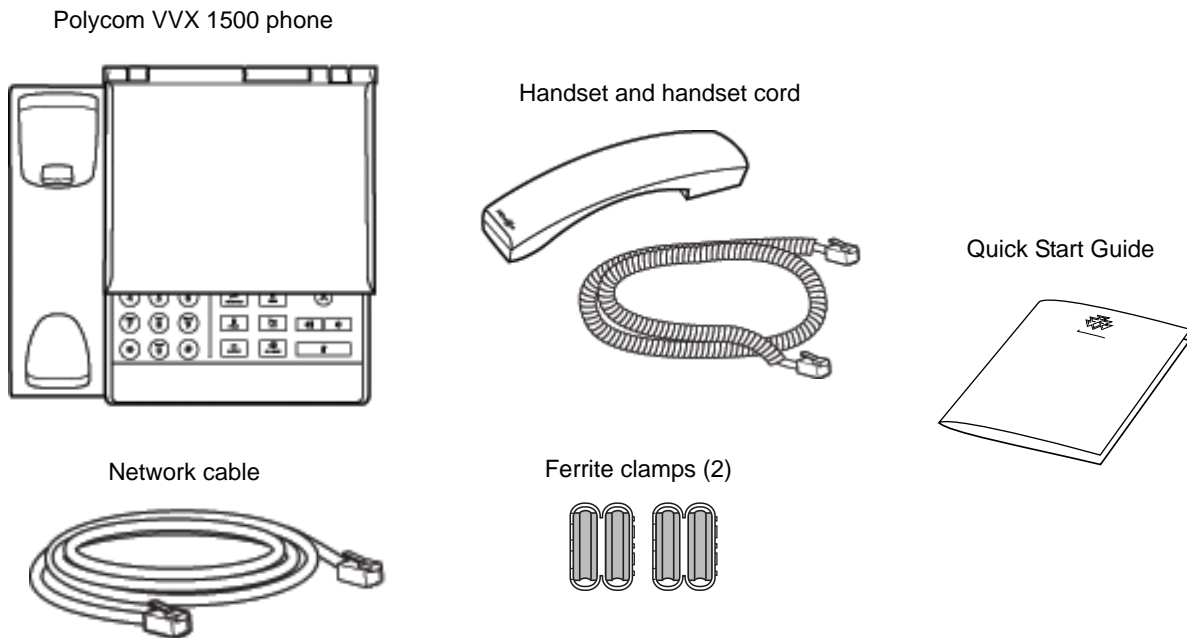

Optional Accessories

The following items are optional accessories for the phone:

- AC Power Kit with:
 - Power Adapter
 - Regional Power Cord
- Headset
- USB flash drive
- Headphones
- Computer Cable

For information on connecting optional accessories, see [Connecting the Phone Using AC Power](#) on page 1-7 and [Connecting Optional Components](#) on page 1-8.

Setting Up Your Phone

To set up the phone, do the following:

1. Adjust the stand. See [Adjusting the Stand](#), below.
2. Connect the ferrite clamps to the network cable (and to the optional computer cable, if you are connecting a computer to your phone). See [Attaching Ferrite Clamps](#) on page 1-5.
3. Connect the phone to the network and a power source. See [Connecting Network and Power Sources](#) on page 1-5.
4. Connect phone components. See [Connecting the Handset and Handset Cord](#) on page 1-8 and [Connecting Optional Components](#) on page 1-8.
5. Adjust the screen and camera. See [Adjusting the Screen](#) on page 1-12 and [Adjusting the Camera](#) on page 1-13.

Adjusting the Stand

Your phone is shipped with the stand positioned flat against the phone. To use the phone, adjust the stand so that the phone is in a more upright position.

You can adjust the stand to one of five positions. The lowest position is labeled MIN, and the highest position is labelled MAX.

The following figure shows the MIN and MAX labels for the stand.

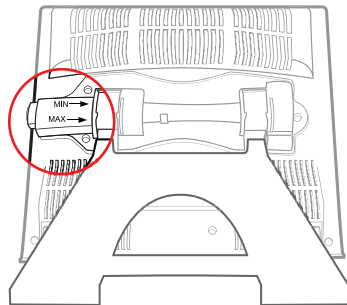

To adjust the stand:

1. With the back of the phone (and the stand) facing you, push the button protruding from the side of the phone. When you push the button, the stand unlocks and can move.

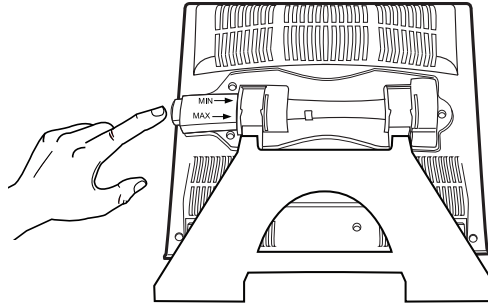

2. Lift the stand until it touches the back of the phone (the position labelled **MIN**), and then release the button to lock the stand in place. This is the lowest, and most stable, position for your phone.

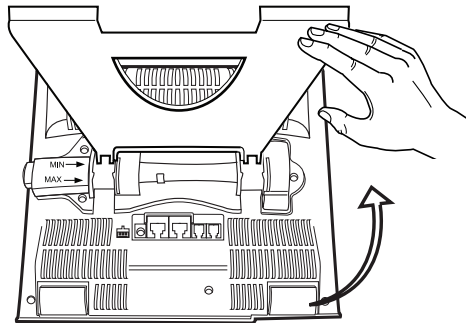

The following figure shows the phone in its lowest position.

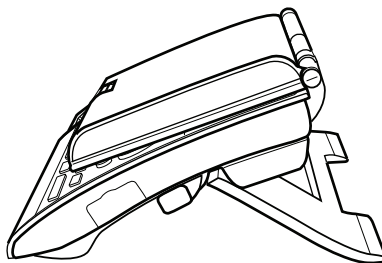

There are four, more upright, positions for your phone. Starting with the stand in its lowest position, push the button, slowly move the stand forward, and then release the button to lock the stand in the next position. Do not force the stand to move past the **MAX** position, or your phone will be unstable.

Note

If you need to store or ship your phone, you can move the stand past the **MAX** position so that the stand lies toward the front of the phone.

Attaching Ferrite Clamps

Your phone package includes two ferrite clamps. You must attach a ferrite clamp to the network cable and to the computer cable (if you are connecting a computer to your phone) before you attach the cables to your phone.

To attach a ferrite clamp to the network cable or PC cable:

>> Clamp a ferrite clamp around the cable.

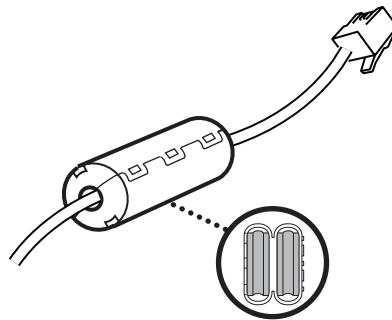

Connecting Network and Power Sources

Note

Before you connect the network cable to your phone, make sure you attach a ferrite clamp to the cable (see [Attaching Ferrite Clamps](#), above).

There are two ways to connect your phone to the network and a power source. Your system administrator will advise you which method to use. (If your phone is already connected to the network and a power source, go directly to [Connecting the Handset and Handset Cord](#) on page 1-8.)

You can use one of the following methods:

- [Connecting the Phone Using a Power Over Ethernet Source](#)
- [Connecting the Phone Using AC Power](#)

Connecting the Phone Using a Power Over Ethernet Source

Using the supplied network cable, the phone can be powered from a Power over Ethernet (PoE) compliant switch or hub. Power over Ethernet is the default connection for your phone.

The following figure shows how to connect the phone using a PoE source.

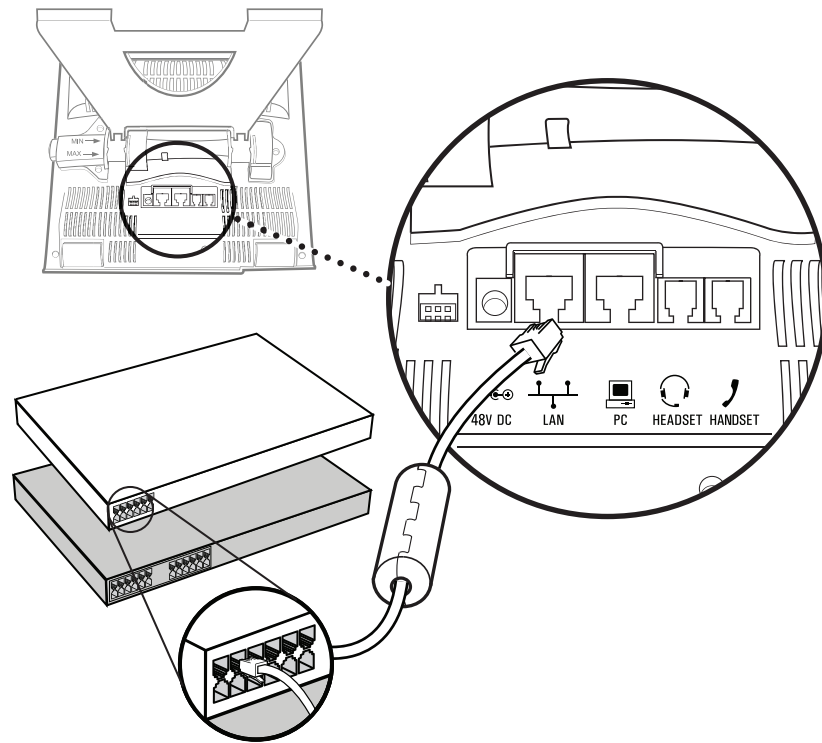

To connect the phone using a PoE source:

- >> Plug the network cable between the LAN jack on the phone and an available power and data port on the in-line power switch.

Connecting the Phone Using AC Power

To connect the phone using AC power, you require the optional AC Power Kit, containing a Power Adapter and Regional Power Cord.

Note

The regional power cord is country-specific. The power cord shown below may differ from the one in your kit.

The following figure shows how to connect the phone using AC power.

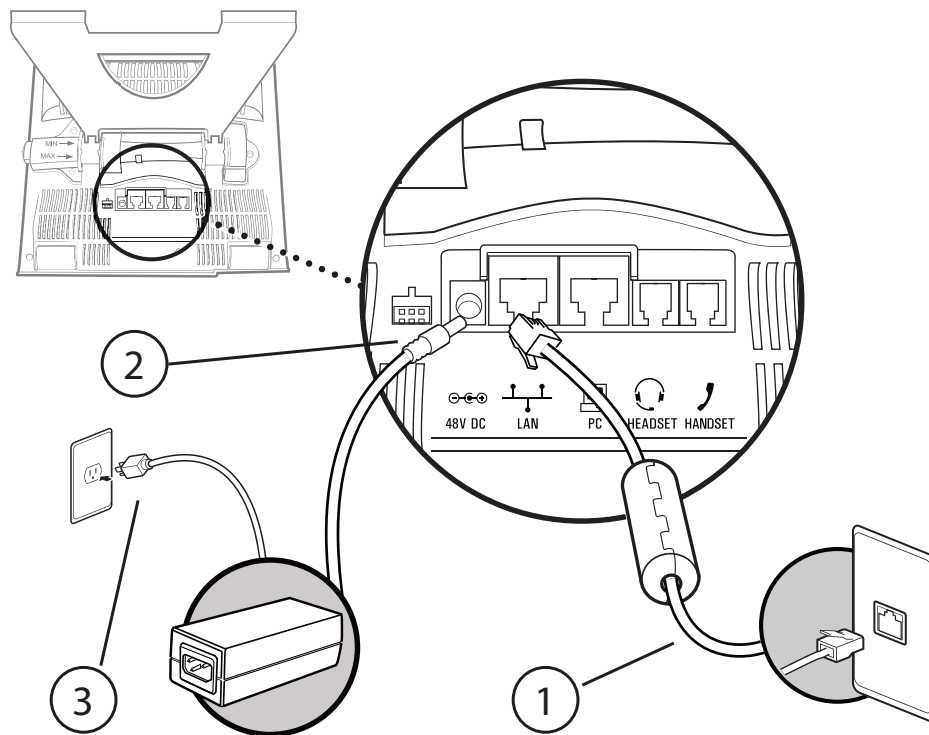

To connect the phone using AC power:

1. Connect the network cable between the LAN jack on the phone and the LAN port on the wall or hub/switch device port.
2. Connect the DC plug on the power adapter to the 48V DC jack marked on the phone.
3. Connect the regional power cord between the power adapter and the wall outlet.

Connecting the Handset and Handset Cord

Connect one end of the handset cord to the end of the handset, and the other end of the cord to the Handset jack on the phone.

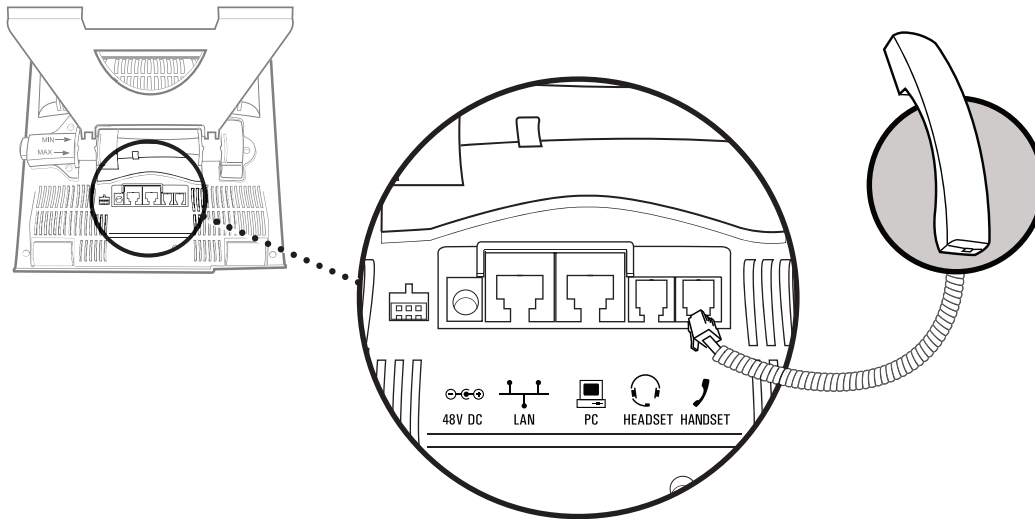

Connecting Optional Components

You can connect a headset, USB flash drive, headphones, or computer to your phone. This section describes:

- [Connecting an Optional Headset](#)
- [Connecting an Optional USB Flash Drive](#)
- [Connecting Optional Headphones](#)
- [Connecting an Optional Computer](#)

Connecting an Optional Headset



For a list of supported headsets, see Technical Bulletin 37477, *SoundPoint IP Family and Polycom VVX 1500 Headset Compatibility List*, at http://www.polycom.com/support/voice/soundpoint_ip/VoIP_Technical_Bulletins_public.html.

Attach a headset to listen to phone audio through a headset, rather than a handset or speakerphone. You attach a headset to the Headset jack on the back of the phone.

The following figure shows how to connect a headset to the Headset jack on the phone.

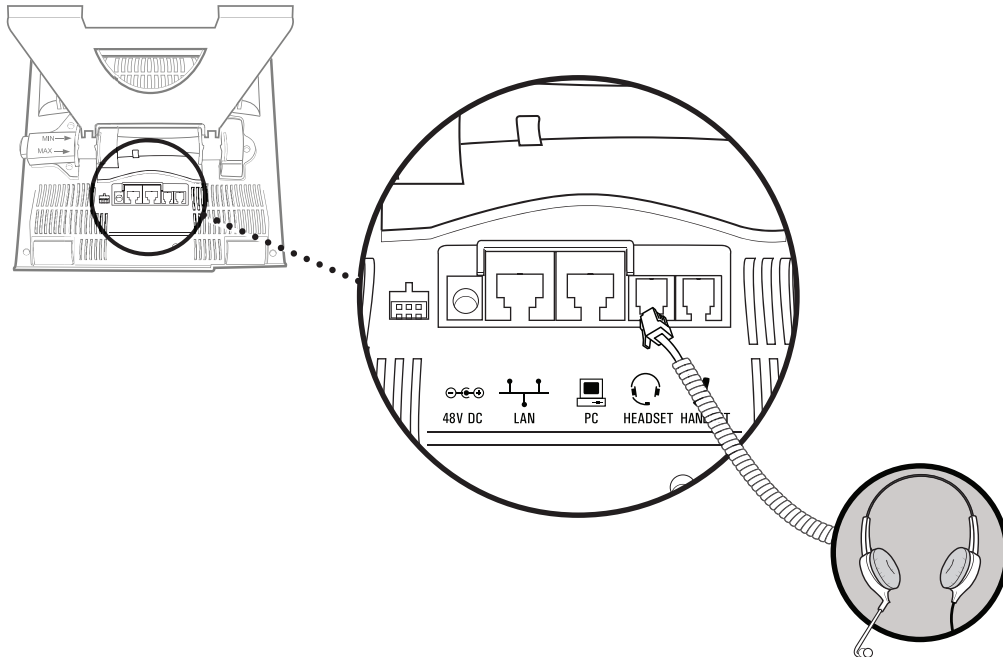

For information on using a headset to place and answer calls, see [Placing Calls](#) on page 3-6 and [Answering Calls](#) on page 3-12. For information on permanently enabling your phone to use headset mode, see [Enabling Headset Memory Mode](#) on page 2-7.

For information on connecting and using a headset that supports electronic hookswitch, see [Using Electronic Hookswitch](#) on page 2-8.

Connecting an Optional USB Flash Drive



For a list of supported USB flash drives, see Technical Bulletin 38084, *Supported USB Devices for SoundPoint IP 650/670 and Polycom VVX 1500 Phones*, at http://www.polycom.com/support/voice/soundpoint_ip/VoIP_Technical_Bulletins_public.html.

Attach a removable USB flash drive to your phone to do the following:

- Record and play back audio from your phone.
- Display images on your phone's idle screen.

You attach the USB flash drive to the USB port on the right side of your phone. The USB port is behind a door you flip down.

The following figure shows how to connect a USB flash drive to the USB port on the phone.

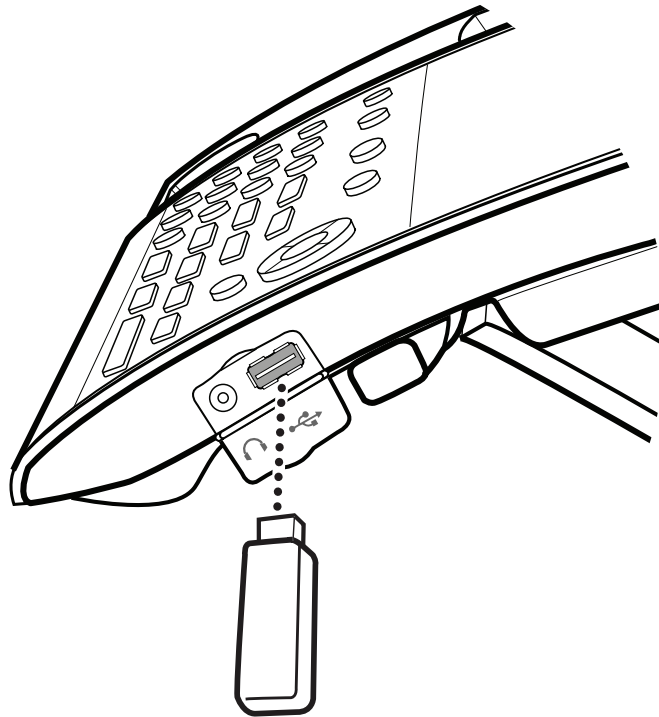

When you attach a USB flash drive to your phone, the message “Storage media attached” displays. The USB flash drive icon, , displays on the status bar on the touch screen.

For information on how to record and play back audio, see [Recording Calls](#) on page 4-17 and [Playing Back Recorded Calls](#) on page 4-23.

For information on how to display the pictures on a USB flash drive on your phone’s idle screen, see [Setting Up a Screen Saver](#) on page 2-9 and [Displaying the Pictures that are Stored on Your USB Flash Drive](#) on page 2-14.

Connecting Optional Headphones

Attach headphones to your phone to listen to phone audio or recorded calls. You attach the headphones to the 3.5mm connector on the side of your phone, located behind a door you flip down. The connector is an unamplified line-out connector only.

The following figure shows the 3.5mm connector on the side of your phone.

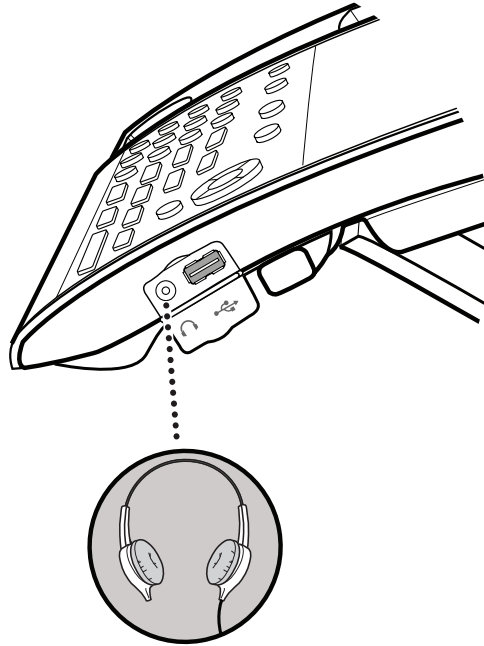

When you attach headphones to your phone, the message “Auxiliary output active” displays. The headphone icon, , displays on the status bar on the touch screen. When you remove the headphones, the message “Auxiliary output inactive” displays.

Connecting an Optional Computer

You can connect a computer to your phone. You may want to connect a computer, for example, if you only have one LAN port and you want to connect your computer to the network through the phone.

To connect a computer to the phone, you need the optional Computer Cable and a ferrite clamp (included in the phone package). Attach the ferrite clamp to the Computer Cable before you attach the cable to your phone (see [Attaching Ferrite Clamps](#) on page 1-5).

You attach a computer to the PC connector on the back of the phone.

The following figure shows how to connect a computer to the PC connector on the phone.

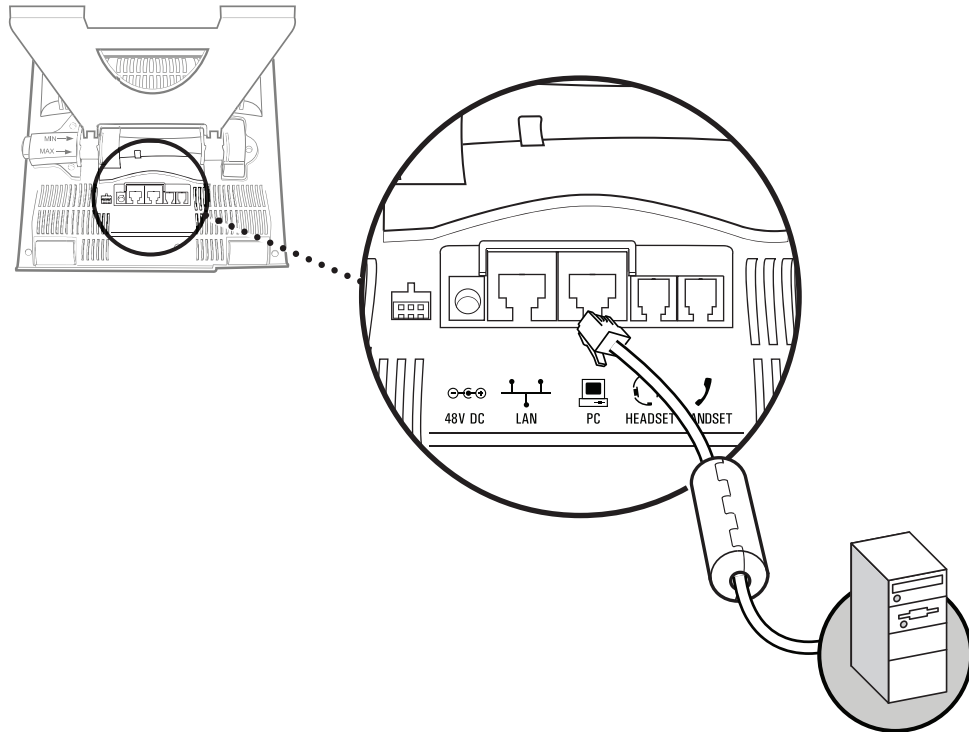

Adjusting the Screen

Lift the screen and push it back to an angle that is comfortable for you.

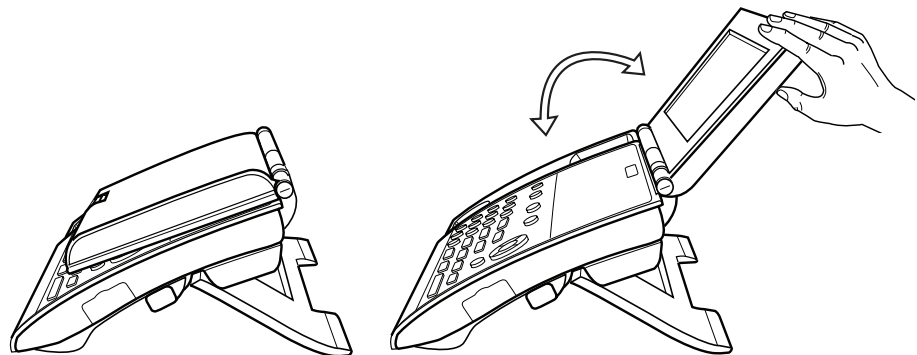

Adjusting the Camera

To transmit video, make sure you slide open the privacy shutter.

The following figure shows the privacy shutter centered above the touch screen. Open the privacy shutter using the privacy shutter adjuster (located along the top edge, above the camera).

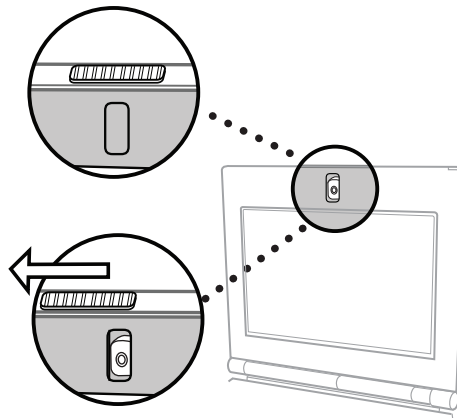

You can adjust the angle of the camera by rolling the camera barrel located directly behind the camera lens.

The following figure shows how to adjust the camera up or down.

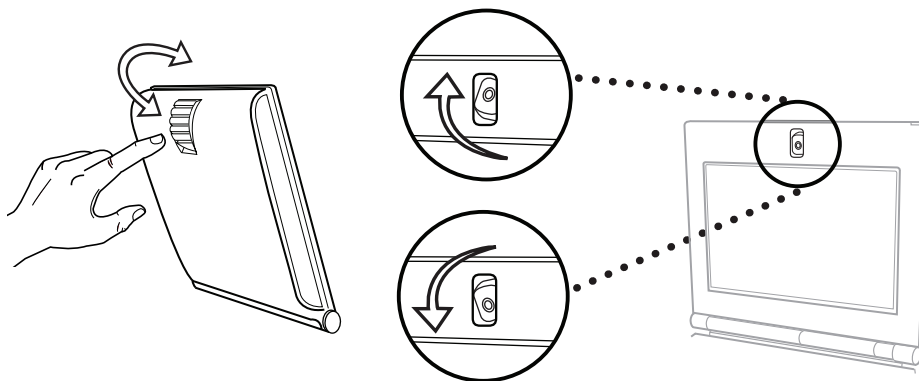

For information on adjusting your camera to achieve the best settings, see [Updating Camera Settings](#) on page 2-32 and [Obtaining the Best Performance from Video Calls and Conferences](#) on page 1-31.

Registering the Phone

Generally, your phone will be deployed with multiple other phones. In this case, your system administrator will configure the phone parameters beforehand, so that after you set up your phone, the phone will be registered and ready to use.

If your phone is not part of a large phone deployment, your phone may not be registered after you set it up. Before you use your phone, you or your system administrator will have to register it.

For detailed information on how to register your phone after you install it, see Quick Tip 44011, *Registering Standalone Polycom SoundPoint IP/SoundStation IP and Polycom VVX 1500 Phones*, available at http://www.polycom.com/support/voice/soundpoint_ip/VoIP_Technical_Bulletins_pub.html

Features of Your Phone



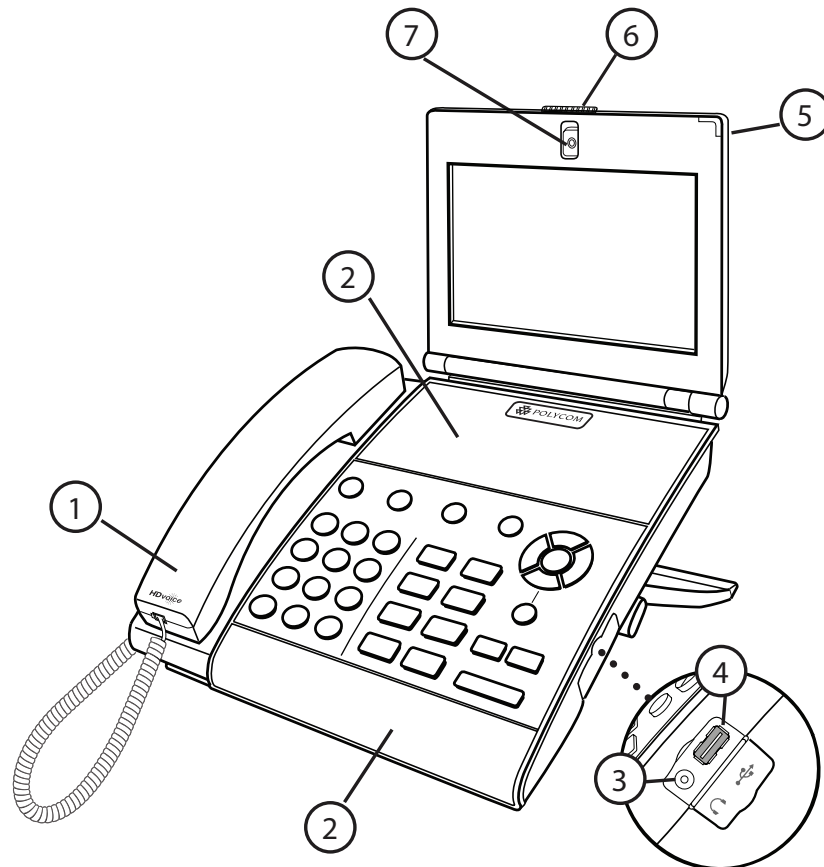

The following figure shows the phone's primary hardware features.



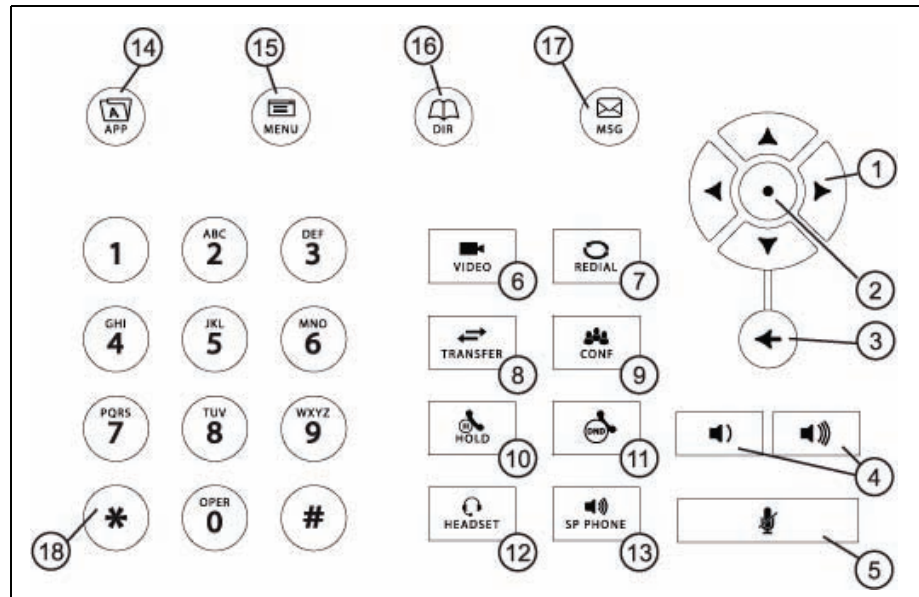

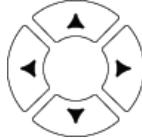











| | Feature | Description |
|---|--------------------------|-----------------------------------------------------------------------------------------------------------------------------------------------------------------------------------------------------------------------------------------------------------------------------------------------------------------------------------------------------------------------------------------------------------------------------------------------------------------------------------|
| 1 | Handset and cord | Provides audio output for calls that use the handset. |
| 2 | Speakerphone | Provides ringer and hands-free (speakerphone) audio output. To use the speakerphone, see Placing Calls on page 3-6, Answering Calls on page 3-12, and Ending Calls on page 3-15. |
| 3 | Headphone connector | Allows you to connect headphones to the phone. |
| 4 | USB connector | Allows you to connect a USB flash drive to display pictures on your phone, and to record and play back calls. |
| 5 | LED indicator | The LED flashes red to indicate the following: <ul style="list-style-type: none"> • The software is booting • A message is waiting. For more information, see Accessing Voice and Video Mail on page 3-42 and Reading and Managing Instant Messages on page 4-2. • The phone is in power-saving mode (slow-flashing red). For more information, see Updating Power Saving Settings on page 2-34. |
| 6 | Privacy Shutter Adjuster | Opens and closes the privacy shutter. For more information, see Adjusting the Camera on page 1-13. |
| 7 | Camera | Provides near-site video. For more information, see Adjusting the Camera on page 1-13. |

The following figure shows the keys on the phone console.



| | Feature | Description |
|---|----------------------------------------------------------------------------------------------------|-------------------------------------------------------------------------------------------------------------------------------------------------------------------------------------------------------------------------------------------------------------------------|
| 1 | Arrow Keys  | Allow you to: <ul style="list-style-type: none"> • Scroll through displayed information. • Enable and disable fields. • Return to the previous menu (Left arrow key only). • Scroll through active and inactive calls. |
| 2 | Select Key  | Selects an item in a list. |
| 3 | Delete Key  | Deletes displayed data. |
| 4 | Volume Keys  | Adjusts the volume of the handset, headset, speaker, and ringer. See Adjusting the Volume on page 2-41. |

| | Feature | Description |
|----|---------------------------------------------------------------------------------------------------------|----------------------------------------------------------------------------------------------------------------------------------------------------------------------------------------------------------------------------------------------------------------------------------|
| 5 | Mute key  | Mutes audio transmission locally during calls and conferences. The button glows red when activated. See Muting the Microphone on page 2-40. |
| 6 | Video Key  | Controls the size, position, and transmission of video images. See Handling Video Calls on page 3-3. |
| 7 | Redial Key  | Dials the most recently dialed party. See Redialing Numbers on page 3-15. |
| 8 | Transfer Key  | Transfers the current call to another party. See Transferring Calls on page 3-25. |
| 9 | Conference Key  | Allows connection with another party for a conference. See Hosting Conference Calls on page 3-18. |
| 10 | Hold Key  | Holds an active call or resumes a held call. See Placing Calls on Hold on page 3-16. |
| 11 | DND Key  | Cancels ringing and directs incoming calls to your voice/video mail (if supported). The button glows red when activated. See Enabling Do Not Disturb on page 3-33. |
| 12 | Headset Key  | Allows you to place and receive calls through an optionally connected headset. The button glows green when headset mode is selected. See Placing Calls on page 3-6, Answering Calls on page 3-12, and Ending Calls on page 3-15. |
| 13 | Speakerphone Key  | Allows for hands-free communication during calls. The button glows green when speakerphone mode is selected. See Placing Calls on page 3-6, Answering Calls on page 3-12, and Ending Calls on page 3-15. |
| 14 | App Key  | Allows you to access special applications using the Launch Pad. For more information, see Using the Launch Pad on page 4-30. |

| | Feature | Description |
|----|----------------------------------------------------------------------------------------------------|----------------------------------------------------------------------------------------------------------------------------------------------------------------------------------------------|
| 15 | Menu Key  | Allows you to access local (your phone) and global (your organization) features. |
| 16 | Dir Key  | Allows you to access local directories and call lists. See Managing Contacts on page 2-44 and Using Call Lists on page 2-41. |
| 17 | Msg Key  | Allows you to access and manage instant, voice, and video messages. See Accessing Voice and Video Mail on page 3-42 and Using Instant Messaging on page 4-1. |
| 18 | Dialpad Keys  | Provide the 10 digits, alphabetic characters, and special characters available in context-sensitive applications. |

Before You Use Your Desktop Phone

Note

Since you can customize your phone in many different ways, and your system administrator can enable and disable certain features, the user interface that displays on your phone may differ from the figures that appear in this guide.







Before you use your phone, you need to understand the touch screen layout, which icons display on the touch screen, how to navigate menus and fields, and how to enter data. You also need to know how to obtain the best performance when you conduct video calls and conferences. This section describes the following:

- [Touch Screen Components](#) on page 1-19
- [Phone Icons](#) on page 1-22
- [Navigating Menus, Lists, and Fields](#) on page 1-24
- [Entering Data and Editing Fields](#) on page 1-27
- [Obtaining the Best Performance from Video Calls and Conferences](#) on page 1-31





Touch Screen Components

The following figure shows what displays on the touch screen.



| | Feature | Description |
|---|------------|-------------------------------------------------------------------------------------------------------------------------------------------------------------------------------------------------------------------------------------------------------------------------------------------------------------------------------------------------------------------------------------------------------------------------------------------------------------------------------------------------------------------------------------------------------------------------------------------------------------------------------------------------------------------------------------------------------------------------------------------------------------------------------------------------------------------------------|
| 1 | Status bar | <p>The following icons can display:</p> <ul style="list-style-type: none">  —Messages waiting  —Missed calls  —Do Not Disturb enabled  —USB flash drive attached and idle  —USB flash drive attached and busy  —Headphones attached |

| | Feature | Description |
|---|-------------------------------|--------------------------------------------------------------------------------------------------------------------------------------------------------------------------------------------------------------------------------------------------------------------------------------------------------------------------------------------------------------------------------------------------------------------------------------------------------------------------------------------------------------------------------------------------------------------------------------------------------------------|
| 2 | Active call window | Displays the active call. During a video call, the active call window can display the near site or the far site. |
| 3 | Inactive call group | Displays calls on hold, as well as incoming calls that are not immediately answered. |
| 4 | Soft keys | Keys on the touch screen you can tap to access phone functions. The keys are automatically labeled to identify their context-sensitive functions. |
| 5 | Main Menu key | Opens the Main Menu. |
| 6 | Line Keys and Speed Dial Keys | See <i>Line Key</i> in this table. See <i>Speed Dial Keys</i> in this table. |
| 7 | Speed Dial Keys | Use these keys to activate up to five speed dials that can be assigned to your phone. Use a Speed Dial Key to quickly dial a contact. Speed Dial Keys display  . For more information on Speed Dial Keys, see Placing Calls Using Speed Dial on page 3-10 and Managing Speed Dial Keys on page 3-38. |
| 8 | Line Key status indicator | A Line Key can have one of the following status indicators: <ul style="list-style-type: none"> • Solid green—A dial-tone is available, dialing is in progress, or a call is active. • Flashing green—An incoming call. • Solid red—A remote shared line is active, or the buddy associated with the Speed Dial Key has a status that is either Offline or Do Not Disturb. • Flashing red—A call (one or more) is on hold (on a private or shared line), or the buddy associated with the Speed Dial Key has a status that is Busy, Be Right Back, Away, or Out to Lunch. |

| | Feature | Description |
|---|----------|--------------------------------------------------------------------------------------------------------------------------------------------------------------------------------------------------------------------------------------------------------------------------------------------------------------------------------------------------------------------------------------------------------------------------------------------------------------------------------------------------------------------------------------------------------------------------------------------------------------------------------------------------------------------------------------------------------------------------------------------------------------------------------------------------------------------------------------------------------------------------------------------------------------------------------------------------------------------------------------------------------------------------------------------------------------------------------------------------------------------------------------------------------------------------------------------------------------------------------------------------------------------------------------------------------------------------------------------------------------------------------------------------------------------------------------------------------------------------------------------------------------------------------------------------------------------------------------------------------------------------------------------------------------------------------|
| 9 | Line Key | <p>Use these keys to activate up to six lines that can be assigned to your phone.</p> <p>When the phone is idle, Line Keys display one of the following:</p> <ul style="list-style-type: none"> •  —for registered, private lines. •  —for registered, shared lines. •  —for unregistered lines •  —for lines that have the Always call forwarding type enabled. •  —for lines that have Do Not Disturb enabled. <p>Line keys are either blue or green:</p> <ul style="list-style-type: none"> • Green—Indicates that the Line Key has an active call or an incoming call. A green Line Key is associated with the calls that currently display on the touch screen (active or inactive). • Blue—Indicates that the Line Key doesn't have an active call, or has an incoming call that has been minimized and placed in the inactive call group. The calls associated with a blue Line Key don't currently display on the touch screen. <p>For more information on lines and Line Keys, see System Customizations on page 2-64. For information on icons that display when your phone has a call, see Phone Icons, below.</p> |









| | Feature | Description |
|----|---------------------------------|------------------------------------------------------------------------------------------------------------------------------------------------------------------------------------------------------------------------------------------------------------------|
| 10 | Picture-in-Picture window (PIP) | The small window in the corner of the touch screen that displays video. By default, the PIP displays the near site. You can toggle the PIP to display the near site or the far site. For more information, see Handling Video Calls on page 3-3. |













Phone Icons







The following table describes the icons that display on the touch screen.

Note

Call counters only display when the icon appears next to the Line Key.

| Icon | Description |
|-------------------------------------------------------------------------------------|--------------------------------------------------------------------------|
|  | Buddy Status (Online) Busy Lamp Field (BLF) indicator (line is idle) |
|  | Buddy Status (Busy, Do Not Disturb) |
|  | Buddy Status (Be Right Back, Away, Out to Lunch) |
|  | Buddy Status (Offline) Busy Lamp Field (BLF) indicator (line is busy) |
|  | Call (audio-only) |
|  | Call with Polycom HD Voice |
|  | Call (video) |
|  | Call (video) with Polycom HD Voice |

| Icon | Description |
|-------------------------------------------------------------------------------------|----------------------------------------------|
|  | Call on hold (private line) |
|  | Call on hold (shared line) |
|  | Call without Polycom HD Voice (private line) |
|  | Call (shared line) |
|  | Conference call |
|  | Conference call (secure) |
|  | Do Not Disturb enabled |
|  | Forward (Always) |
|  | Headphones attached |
|  | Line (registered, private) |
|  | Line (registered, shared) |
|  | Line (unregistered) |
|  | Message indicators |

| Icon | Description |
|------------------------------------------------------------------------------------|------------------------------------------------------------------------|
|  | Missed calls indicator |
|  | Mute applied |
|  | Speed Dial Key |
|  | USB flash drive attached and idle |
|  | USB flash drive attached and busy (recording, playing back, or paused) |
|  | Video stopped |
|  | Video stopped and audio muted |

Navigating Menus, Lists, and Fields











To navigate menus, lists, and fields, you can:

- Tap the soft keys on the touch screen
- Tap the menu items or fields on the touch screen
- Press the keys on the phone console

To operate your phone, follow these tips:

Note

After 20 seconds of inactivity, the menu system automatically exits to the idle screen unless an edit session is in progress.

| If you want to ... | Then do this ... |
|--------------------------------|------------------------------------------------------------------------------------------------------------------------------------------------------------------------------------------------------------------------------------------------------------------------------------------------------------------------------------------------------------------------------------------------------------------------------------------------------------------------------------------------------------------------------------------------------------------------------------------------------------------------------------------------------------------------------------------------------------------------------------------------------------------------------------------------------------------------------------------------------------------------|
| Enter the Main Menu | Tap  or press  . |
| Return to the idle screen | Tap  or press  . |
| Return to the previous menu | Tap the Back soft key or press the Left arrow key. |
| Scroll through menu items | Tap  or  , or press an arrow key. |
| Scroll through lists or fields | <p>To scroll item by item, do one of the following:</p> <ul style="list-style-type: none"> • Tap  or . <p>or</p> <ul style="list-style-type: none"> • Press the Up or Down arrow key <p>To Page Down or Page Up (when lists appear on more than one page), do one of the following :</p> <ul style="list-style-type: none"> • Tap  or . <p>or</p> <ul style="list-style-type: none"> • Press the * key (to Page Up) or the # key (to Page Down). |
| Select a menu item | <p>Do one of the following:</p> <ul style="list-style-type: none"> • Tap the menu item. • Use an arrow key to scroll to the menu item, and then tap the Select soft key. • Press the dialpad key that corresponds to the item in a numbered menu list. <p>For example, if an item has a number next to it, press the corresponding number on the dialpad.</p> |
| Select a field | <p>Do one of the following:</p> <ul style="list-style-type: none"> • Tap the field. • Scroll to the field using the Up or Down arrow key. |

| If you want to ... | Then do this ... |
|---------------------------|----------------------------------------------------------------------------------------------------------------------------------------------------------------------------------------------------------------------------------------------------------------------------------------------------------------------------------------------------------------------------------------------------------------------------------------------------------|
| Select a soft key | Tap the soft key. |
| View additional soft keys | Tap the More soft key. |
| Enable or disable fields | Do one of the following: <ul style="list-style-type: none"><li data-bbox="883 464 1403 548">• Tap the field name, and then tap the field's highlighted box. From the drop-down list, tap Enabled or Disabled.<li data-bbox="883 558 1403 642">• Scroll to a field using the Up or Down arrow key, and then use the Right or Left arrow key to toggle between Enabled or Disabled. |

Entering Data and Editing Fields

You can enter data and edit fields in these two ways:

- Using a “keyboard” that displays on the touch screen.
- Using the dialpad keys on the phone console.

Using the “Keyboard” on the Touch Screen

You can use the phone’s “keyboard” to quickly update field information.

To use the “keyboard” on the touch screen to enter or edit data:

1. To update a field, tap the field.

The keyboard icon, , displays next to the screen title.

The following screen shows the keyboard icon next to the screen title.

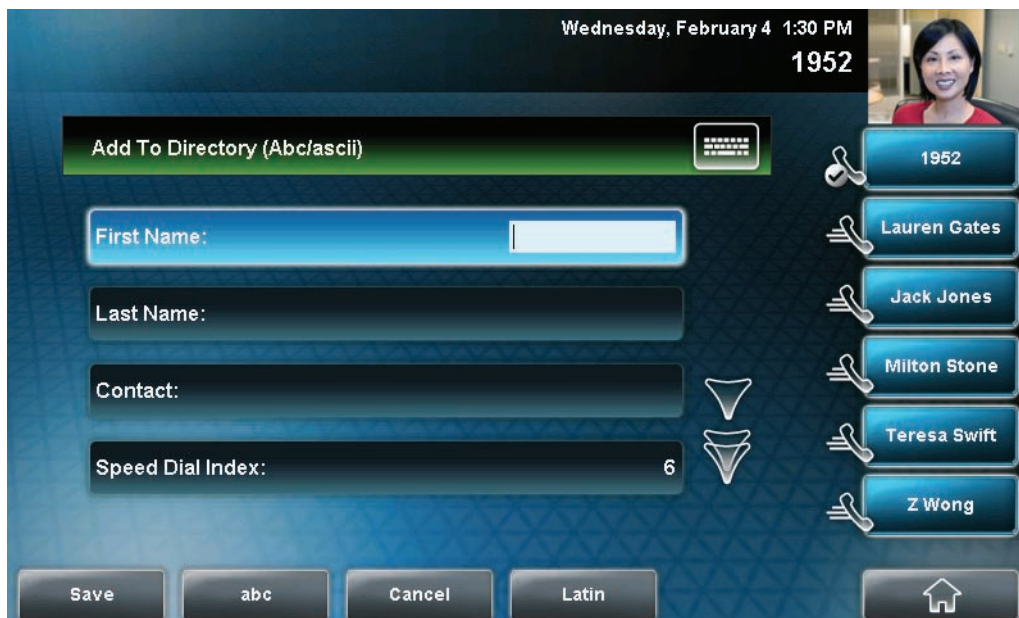



2. Tap .





The “keyboard” displays on the touch screen.

The following figure shows the keyboard that displays on the touch screen when you update a directory entry.



3. Enter the information. Do the following:

| If you want to... | Then do this... |
|-------------------------------------------------------------------------------------------------------------------|--------------------------------------------------------------------------------------------------------------------------------------------------------------------------------------------------------------------------------------------------------------------------------------------------------------------------------------------------------------------------------------------------------------------------------------------------------------------------------------------------------------------------------------------------------------------------------------------------------------------------------------------------------------------------------------------------------------------------------------|
| Enter uppercase (A) characters, lowercase (a) characters, or a combination of uppercase and lowercase characters. | <ol style="list-style-type: none"> 1. If a keyboard with characters does not display, tap  (on the keyboard). 2. Tap the abc, ABC, 123, or Abc soft keys to toggle between lowercase, uppercase, numerical, and titlecase modes. 3. Using the keyboard on the touch screen, tap the letter(s) you want. You can also tap  or  to toggle between entering characters in uppercase mode or lowercase mode. |

| If you want to... | Then do this... |
|----------------------------------|--------------------------------------------------------------------------------------------------------------------------------------------------------------------------------------------------------------------------------------------------------------------------------------------------------------------------------------------------------------------------------------------------------------------------------------------|
| Enter numbers | <ol style="list-style-type: none"> 1. If a keyboard with numbers does not display, tap . 2. Using the keyboard on the touch screen, tap the number(s) you want. <p>You can also tap the abc, ABC, 123, or Abc soft keys to toggle between lowercase, uppercase, numerical, and titlecase modes.</p> |
| Enter special characters | <ol style="list-style-type: none"> 1. If a keyboard with special characters does not display, tap . 2. Using the keyboard on the touch screen, tap the special character(s) you want. |
| Enter text in a special language | <ol style="list-style-type: none"> 1. Tap the Latin, Katakana, Unicode, Cyrillic or ASCII soft key to select the language you want. The touch screen's keyboard changes to display the special language you chose. 2. Using the keyboard on the touch screen, tap the character(s) you want. |
| Delete data you entered | Tap  . |
| Delete an entire field of data | Double-tap the field of data, so that the data is highlighted. Then, tap  . |

4. To confirm the updates, tap .

Using the Dialpad Keys on the Phone Console

You can use the keys on your phone console to update field information.

To use the dialpad keys to enter or edit data:

1. Tap a field to select it.
2. Enter the information. Do the following:

| If you want to... | Then do this... |
|------------------------------------------------------------------------------------------------------------|-------------------------------------------------------------------------------------------------------------------------------------------------------------------------------------------------------------------------------------------------------------------------------------------------------------------------------------------------------------------------------------------------------------------------------------------------------------------------------------------------------------------------------------------------------------------------------------------------------------------------------------------------------------------------------------------------|
| Enter only numbers (1), uppercase (A) characters, lowercase (a) characters, or titlecase (Abc) characters. | <ol style="list-style-type: none"> 1. Tap the abc soft key one or more times to toggle between and select uppercase (ABC soft key), numerical (123 soft key), titlecase (Abc soft key), and lowercase (abc soft key) modes. The mode you select displays in the screen title. 2. Press a dialpad key one or more times to enter the characters or number that display on the dialpad key. For example: If you're in ABC mode: To enter "A," press 2 . To enter "B," press 22 . To enter "C," press 222 . To enter "2," press 2222 . If you're in 123 mode: To enter "2," press 2 . |
| Enter special characters | <ol style="list-style-type: none"> 1. Tap the ABC, Abc, or 123 soft key so that you're in either ABC, Abc, or abc mode. (You can't access special characters when you're in 123 mode.) The mode you select displays in the screen title. 2. Press the 1, *, and 0 keys on the dialpad one or more times. |
| Enter text in a special language | <ol style="list-style-type: none"> 1. Tap the Latin, Katakana, Unicode, Cyrillic or ASCII soft key to select the language you want 2. Press a dialpad key one or more times to enter the character you want. |
| Delete text you entered | Use the Right or Left arrow key to position the cursor to the right of the text you want to delete, and then press  . |

3. Tap the **Save** soft key.

Obtaining the Best Performance from Video Calls and Conferences



Use these tips when you host a video call or conference:

- Check the near-site video to make sure it is clear, bright, and sharp. For information on adjusting camera settings, see [Updating Camera Settings](#) on page 2-32.
- Use the handset or a headset if you are in an open environment.
- Be aware of latency when speaking.
- Avoid bright lights or windows behind you (backlight). If the camera faces a window or bright lights, you may have to adjust the camera settings. To adjust camera settings, see [Updating Camera Settings](#) on page 2-32.
- Avoid wearing bright colors, all-light or all-dark clothing, or “busy” patterns (such as small checks or narrow stripes). Light pastels and muted colors look the best on the screen.
- Mute the microphone if you have to cough, move, or shuffle papers, etc.
- In a conference call, mute your microphone when you are not speaking, especially in noisy environments.
- Avoid tapping the microphone or rustling papers near the microphone.
- Make sure that you can see and hear the far-site participants.
- Speak in your normal voice without shouting. Use natural gestures when you speak.

Cleaning the Touch Screen

Periodically, you may need to clean the touch screen. Fingerprints tend to show up more on a color display.

Before you clean the touch screen, disable the screen so you do not activate phone features while you wipe the glass. While the touch screen is disabled, all soft keys are disabled. You can enable the touch screen again by pressing any key on the phone console.

To answer a call while the touch screen is disabled, pick up the handset. Or, to use the speakerphone or your headset, press  or , and then tap the **Answer** soft key.

To clean the touch screen:

1. Tap  > **Settings** > **Basic** > **Screen Clean**.

The screen is disabled. The message “Touch screen is disabled. Press any key to exit” displays.

2. Wipe the glass with a clean, lint-free cloth.
3. To enable the touch screen again, press any key on the phone console.

Customizing Your Phone

You can customize your Polycom VVX 1500 phone by adjusting certain settings, such as how the time and date display and the ring type you use for incoming calls. You can also customize your phone's directory, specify how to handle calls from contacts, change the background image that displays, or enable a screen saver.

This chapter provides basic operating instructions for customizing your phone. The topics include:

- [Configuring Basic Settings](#) on page 2-2
- [Muting the Microphone](#) on page 2-40
- [Adjusting the Volume](#) on page 2-41
- [Using Call Lists](#) on page 2-41
- [Managing Contacts](#) on page 2-44
- [Managing Incoming Calls](#) on page 2-60
- [System Customizations](#) on page 2-64

Some customizations of your phone are performed by your system administrator. These include:

- [Supporting Multiple Lines](#) on page 2-64
- [Supporting Multiple Line Keys Per Line](#) on page 2-67
- [Supporting Shared Lines](#) on page 2-68

To read about the phone's basic features, see [Using the Basic Features of Your Phone](#) on page 3-1. To read about the phone's advanced features, see [Using the Advanced Features of Your Phone](#) on page 4-1.

If you require additional information or assistance with your new phone, contact your system administrator.

Configuring Basic Settings

This section outlines the basic settings you can configure through the Main Menu. The topics include:

- [Changing the Language on page 2-23](#)
- [Changing the Appearance of Time and Date on page 2-3](#)
- [Enabling Headset Memory Mode on page 2-7](#)
- [Using Electronic Hookswitch on page 2-8](#)
- [Updating the Background Picture on page 2-8](#)
- [Setting Up a Screen Saver on page 2-9](#)
- [Stopping and Disabling a Screen Saver on page 2-13](#)
- [Displaying the Pictures that are Stored on Your USB Flash Drive on page 2-14](#)
- [Setting a Picture on Your USB Flash Drive as the Background Picture on Your Phone on page 2-16](#)
- [Changing the Backlight Intensity on page 2-17](#)
- [Updating the Ring Tone on page 2-20](#)
- [Disabling and Stopping Video on page 2-23](#)
- [Updating Video Settings on page 2-24](#)
- [Updating Power Saving Settings on page 2-34](#)

Changing the Language

Your phone supports several languages.

To change the language:

1. Tap  > **Settings** > **Basic** > **Preferences** > **Language**.

The Language screen displays.



2. Tap the language you want, and then tap the **Select** soft key.
The text on the screen changes to the language that you selected.
3. Tap  to return to the idle screen.

Changing the Appearance of Time and Date

The time and date appear on the graphic display of the phone. If the phone cannot obtain a time and date, the display will flash. Contact your system administrator if either the time or date is incorrect.

You can select from various formats for the time and date display, including whether the time or date displays first (clock order). You can also turn the time and date display off, so it doesn't display on the screen. Select and set options that are right for you.

The following figure shows the default format for the date and time display.



To update the time and date display:

1. Tap  > Settings > Basic > Preferences > Time & Date.

The Time & Date screen displays.

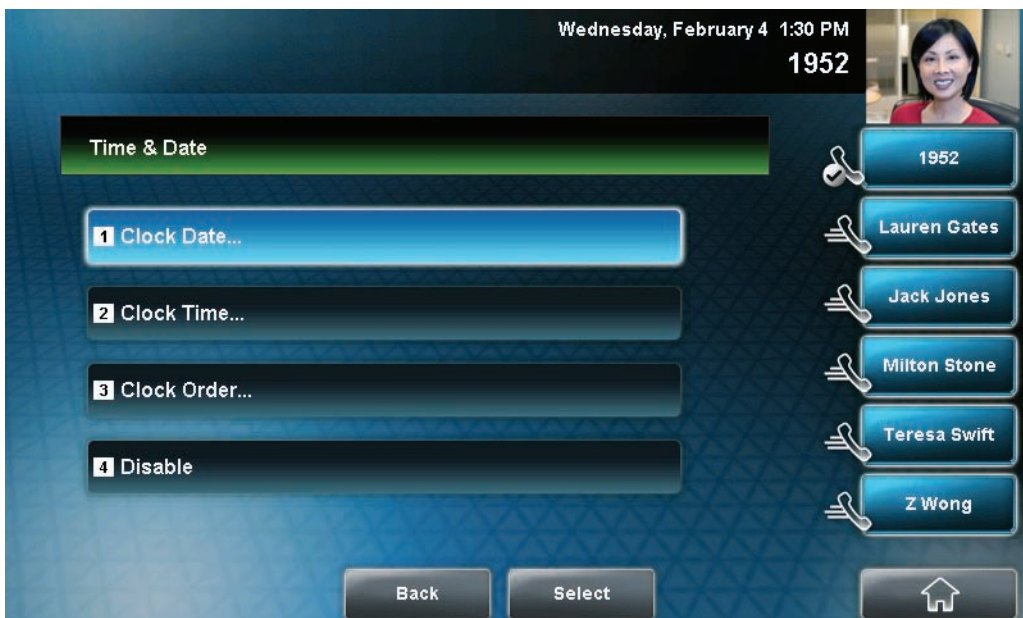

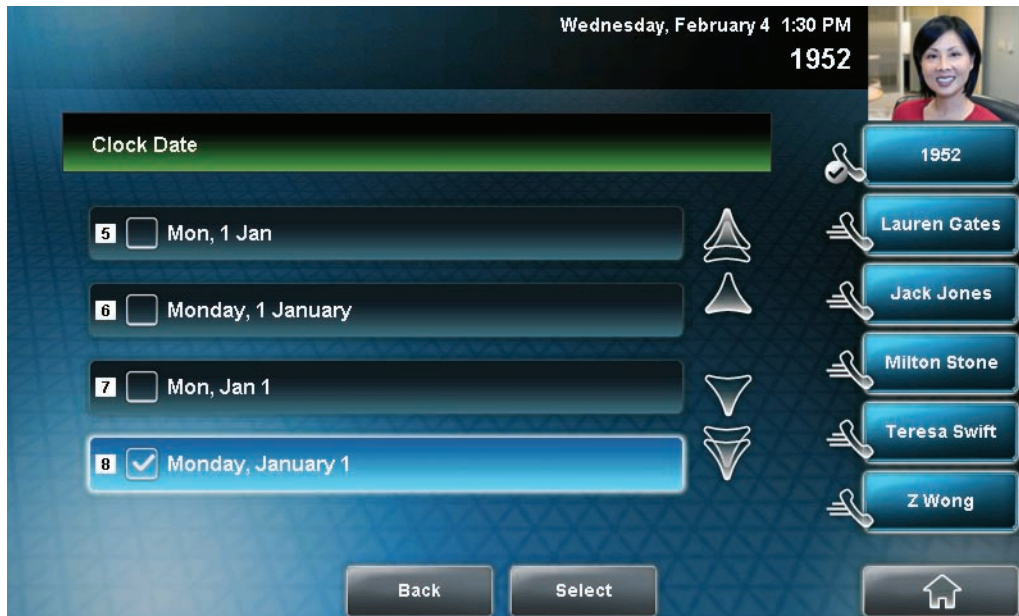

2. Do one of the following:
 - To change the date format, tap **Clock Date**.
 or
 - To change the time format, tap **Clock Time**.

The Clock Date screen or the Clock Time screen displays.

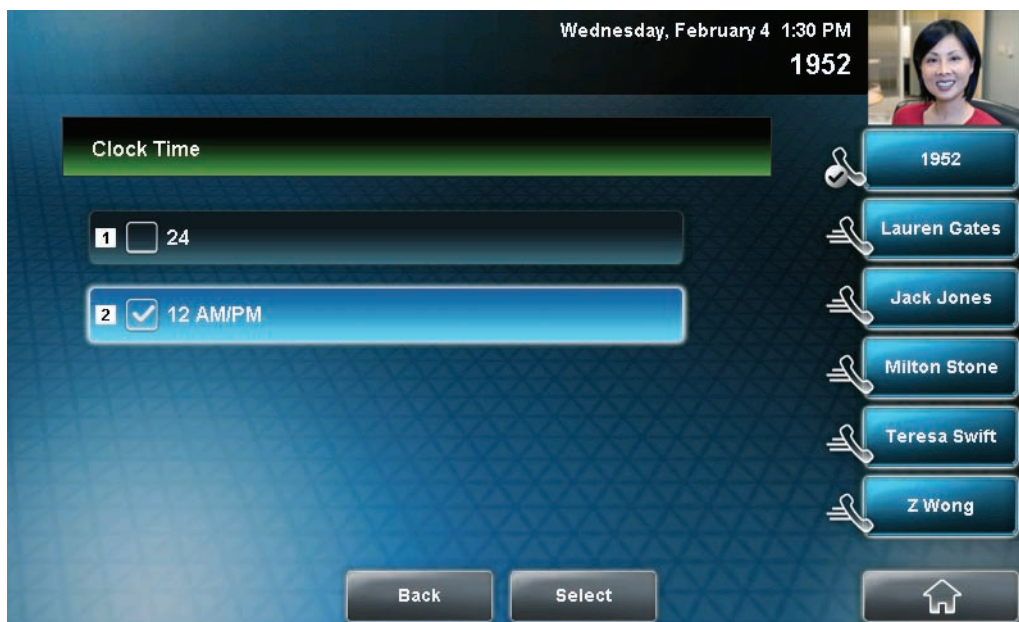

or





3. Tap the format you want, and then tap the **Select** soft key.
4. Tap  to return to the idle screen.

To change the order of the time and date display:

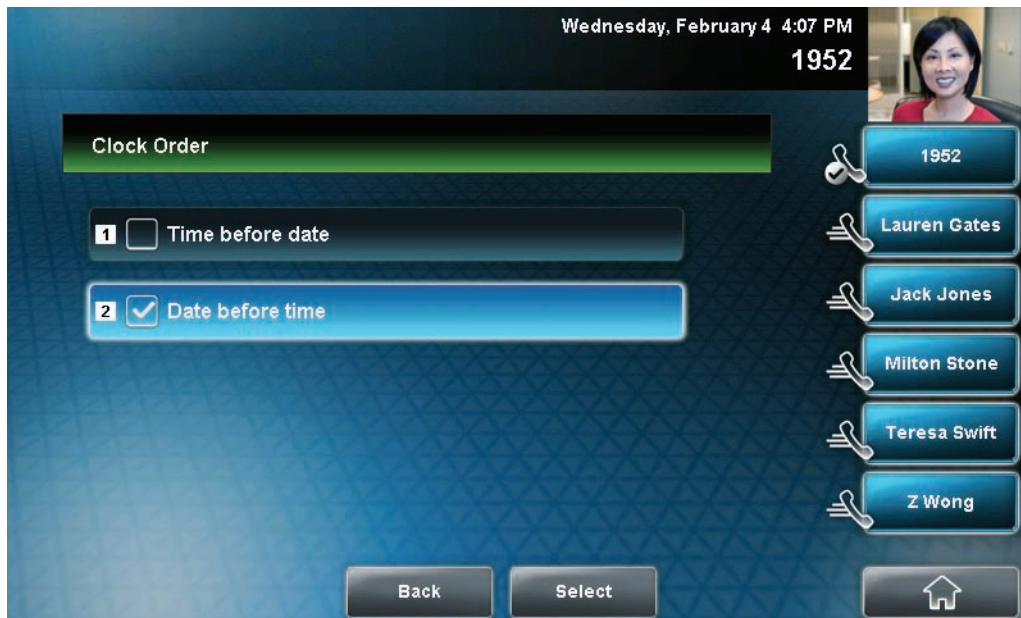

1. Tap  > **Settings** > **Basic** > **Preferences** > **Time & Date** > **Clock Order**.

The Clock Order screen displays.



2. Tap the clock order you want, and then tap the **Select** soft key.
The default setting is date before time.
3. Tap  to return to the idle screen.

To enable or disable the time and date display:

1. Tap  > **Settings** > **Basic** > **Preferences** > **Time & Date**.
2. From the Time & Date screen, do one of the following:
 - To disable the time and date display, tap **Disable**.
 - or
 - To enable the time and date display, tap **Enable**.
3. Tap  to return to the idle screen.

Enabling Headset Memory Mode



For a list of supported headsets, see Technical Bulletin 37477, *SoundPoint IP Family and Polycom VVX 1500 Headset Compatibility List*, at http://www.polycom.com/support/voice/soundpoint_ip/VoIP_Technical_Bulletins_public.html.

This feature is useful for permanent or full-time headset users. You can set up your phone so that all incoming and outgoing calls use your headset. At any time, you can switch to handset or speakerphone mode.

To use Headset Memory Mode, you must enable, and then activate, Headset Memory Mode. If you switch to handset or speakerphone mode, you deactivate Headset Memory Mode. To switch back to Headset Memory Mode, you must activate it again.

To enable Headset Memory Mode:

1. Tap  > **Settings** > **Basic** > **Preferences** > **Headset** > **Headset Memory**.

The Headset Memory Mode screen displays.



2. Tap **Enabled**, and then tap the **Select** soft key.
3. To activate Headset Memory Mode, press  twice.

All calls will now go to your headset. If you tap the Line Key with the flashing green status indicator or the **Answer** soft key to receive a call, the call will connect to your headset automatically.

If you switch to the speakerphone or the handset, you deactivate Headset Memory Mode (calls no longer automatically go to your headset, unless you choose this mode). To have calls go to your headset again, activate

Headset Memory Mode (press  twice).

Using Electronic Hookswitch



For information on supported headsets to provide electronic hookswitch features to place, answer, and end calls, see Technical Bulletin 37477, *SoundPoint IP Family and Polycom VVX 1500 Headset Compatibility List*, at http://www.polycom.com/support/voice/soundpoint_ip/VoIP_Technical_Bulletins_public.html.

If you use a headset that supports electronic hookswitch, you can place, answer, and end calls by pressing the hookswitch button on your headset.

For detailed information about how to use electronic hookswitch, see Technical Bulletin 35150, *Using an Electronic Hookswitch with SoundPoint IP and Polycom VVX 1500 Phones*, at http://www.polycom.com/support/voice/soundpoint_ip/VoIP_Technical_Bulletins_public.html.

Updating the Background Picture

Note

Updating the background picture is an optional feature and may not be supported on your particular system. For more information, see your system administrator.

You can change the background picture that displays on your phone. By default, your screen displays a blue-patterned background that is named "Default."

Your system administrator sets up the background images for your phone. If no background images are set up, only the blue-patterned background ("Default") is available. If you want, you can set up a picture of your own as the background image. For more information, see [Setting a Picture on Your USB Flash Drive as the Background Picture on Your Phone](#) on page 2-16.

To update the background picture:

1. Tap  > **Settings** > **Basic** > **Preferences** > **Backgrounds**.

The Backgrounds screen displays.

The following figure shows a sample Backgrounds screen. (Your screen will have the Default option, as well as other options that your system administrator may have added to your phone. If you set an image on your USB flash drive as your background image, the image will display in the list as "Local File.")

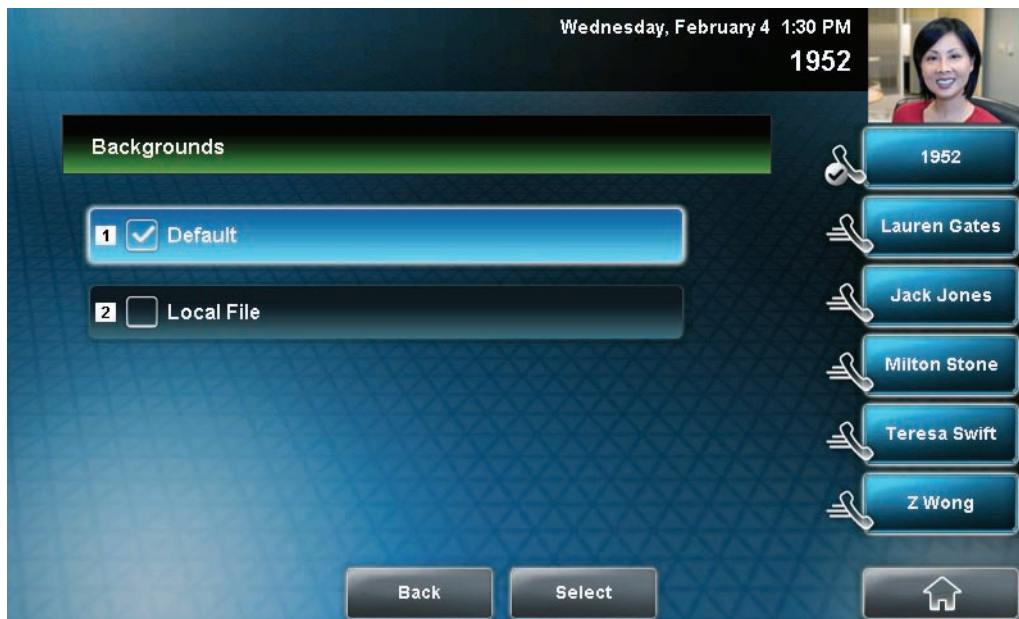

2. Tap the background image you want, and then tap the **Select** soft key.
3. Tap  to return to the idle screen.

Setting Up a Screen Saver

Note

Adding a screen saver to your phone is an optional feature and may not be supported on your system. For more information, see your system administrator.

Note

You may want to view your pictures like a slide show (or just view one picture) without setting up a screen saver that automatically starts each time your phone is idle a certain amount of time. This is the Picture Frame feature. For more information, see [Displaying the Pictures that are Stored on Your USB Flash Drive](#) on page 2-14.

Note

When you view Launch Pad applications (either from Launch Pad or from the idle screen), your phone is considered idle, and a screen saver (if set up) will still display. For more information on Launch Pad and viewing applications, see [Using the Launch Pad](#) on page 4-30.

You can set up a screen saver to display the pictures stored on a USB flash drive. The screen saver will automatically start each time your phone is idle a certain amount of time. You can stop the screen saver at any time and return to the idle screen by tapping the touch screen. If your phone is idle again (for a specified period of time), the screen saver will start again.

To set up a screen saver of your pictures, you need to set up certain screen saver settings, place your pictures on a USB flash drive, and attach the USB flash drive to the phone. Your phone can only display the screen saver when the USB flash drive is attached to your phone.



For a list of supported USB flash drives, see Technical Bulletin 38084, *Supported USB Devices for SoundPoint IP 650/670 and Polycom VVX 1500 Phones*, at http://www.polycom.com/support/voice/soundpoint_ip/VoIP_Technical_Bulletins_public.html.

For information on stopping and disabling a screen saver, see [Stopping and Disabling a Screen Saver](#) on page 2-13.

To set up a screen saver of your pictures:

1. Place one or more pictures on a USB flash drive, either in the root directory or in a folder.

The pictures must have the following file type and size:

File type: BMP, JPEG, or PNG

Maximum size: 9999 x 9999 pixels

Note

The phone will not display images that have a progressive JPEG, .JPE, or .JFIF format.

2. Attach the USB flash drive to your phone (see [Connecting an Optional USB Flash Drive](#) on page 1-9).

The USB icon, , displays on the status bar on the touch screen.

3. Tap  > **Settings** > **Basic** > **Preferences** > **Picture Frame**.

The Picture Frame screen displays.



4. Specify the folder in which you stored your images on the USB flash drive, and the length of time you want each image to display:
- In the **Folder** field, enter the name of the folder in which you placed your images on the USB flash drive.
If you did not place the pictures in a folder (that is, you placed your pictures in the root directory), do not enter a folder name.
 - Tap the **Time Per Image** field, and then enter the number of seconds you want each picture to display.
You can enter a minimum of 3 seconds and a maximum of 300 seconds. The default is 5 seconds.
5. Tap the **Save** soft key.
If the message “No pictures found” displays after you tap the Save soft key, there are no pictures in the folder you specified, or in the root directory (if you did not enter a folder name). Go back and make sure the information you entered is correct.
6. Tap  to return to the idle screen.

7. From the idle screen, tap  > **Settings** > **Basic** > **Preferences** > **Screen Saver**.

The Screen Saver screen displays.

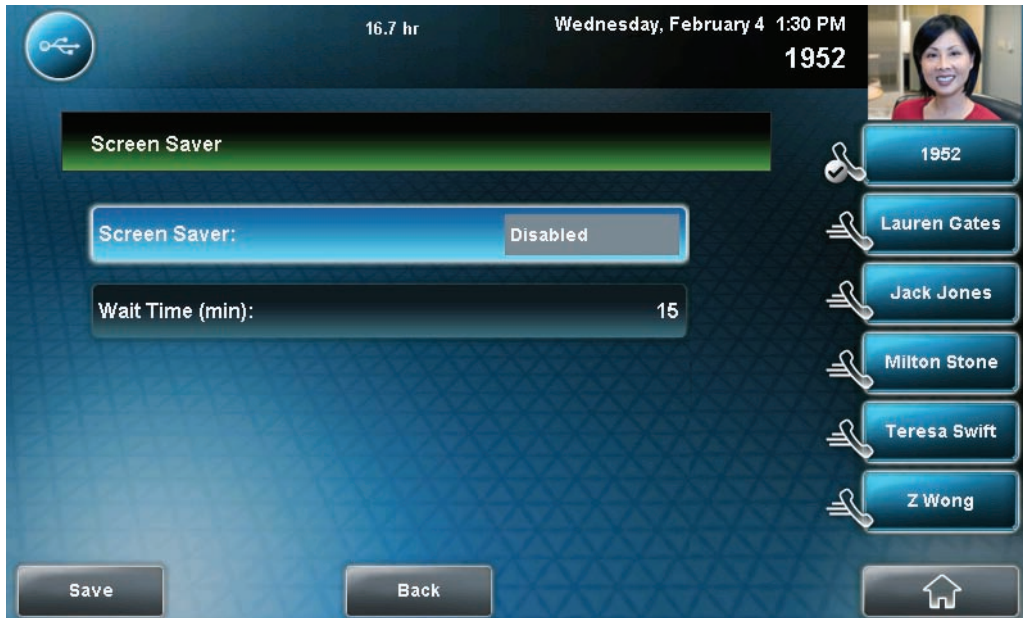

8. Do the following:
 - Tap the **Screen Saver** field's highlighted box. From the drop-down list, tap **Enabled** to enable a screen saver.
 - Tap the **Wait Time** field, and then enter the number of minutes the phone should wait after no activity before displaying the screen saver.
You can enter a minimum of 1 minute and a maximum of 9999 minutes. The default is 15 minutes.
9. Tap the **Save** soft key.
10. Tap  to return to the idle screen.

After the number of minutes you specified in the Wait Time field, your phone will display the screen saver.

You can stop the screen saver at any time by tapping the touch screen (but the screen saver will re-start if your phone is idle again.)

Stopping and Disabling a Screen Saver

You can stop a screen saver at any time, and display the idle screen, by tapping the touch screen. After your phone is idle for the specified period of time, the screen saver will start again.

You can disable a screen saver (prevent it from starting, even if your phone has been idle for the specified period of time) by doing the following:

- Removing the USB flash drive.
The screen saver will not display until you attach the USB flash drive again (and your phone has been idle for the period of time you specified).
- Disabling the **Screen Saver** setting. When you disable the setting, the screen saver will not display, even though the USB flash drive is still attached.

To disable the Screen Saver setting:

1. Tap  > **Settings** > **Basic** > **Preferences** > **Screen Saver**.

The Screen Saver screen displays.

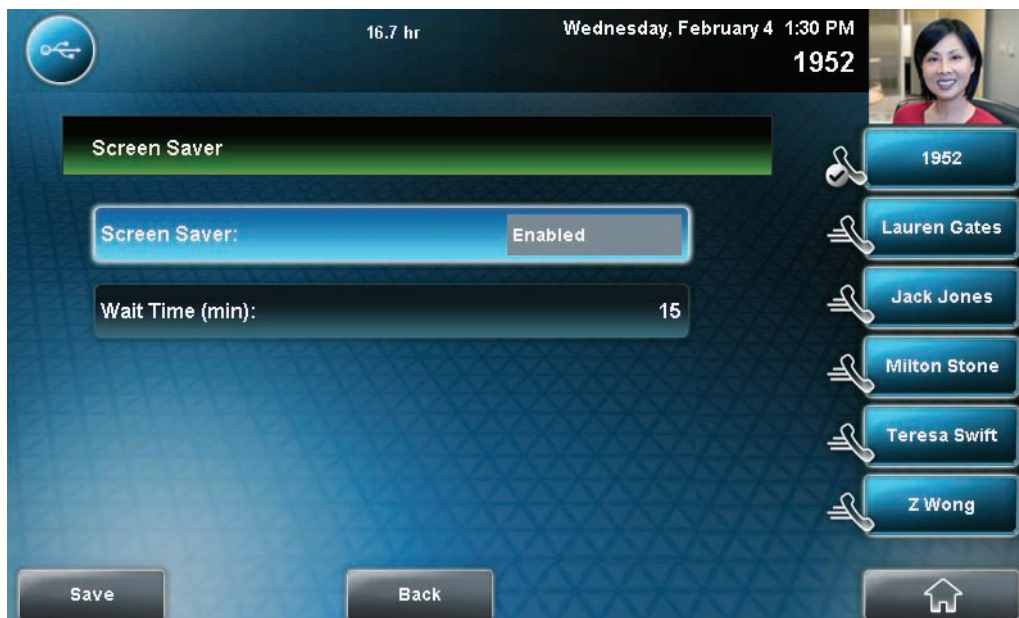

2. Tap the **Screen Saver** field's highlighted box. From the drop-down list, tap **Disabled** to disable the screen saver.
3. Tap the **Save** soft key.
4. Tap  to return to the idle screen.

Displaying the Pictures that are Stored on Your USB Flash Drive

You can view the pictures that are stored on your USB flash drive at any time, without setting up a screen saver that automatically starts each time your phone is idle a certain amount of time. This is called the Picture Frame feature. You can display your pictures as thumbnails, one-by-one (like a slide show), or display just one picture. When you decide to stop viewing your pictures, the idle screen displays, and your pictures will not display again until you choose to display them (unless a screen saver is set up, or you enable a screen saver).



Before you can display your pictures, confirm the following:

- Your pictures are on the USB flash drive, and the USB flash drive is attached to your phone.
- You have specified the folder the pictures are in on your USB flash drive.

For information on how to place pictures on a USB flash drive, connect the USB flash drive to your phone, and specify a folder, see [Setting Up a Screen Saver](#) on page 2-9 .

To display the pictures on your USB flash drive:

1. Do one of the following:





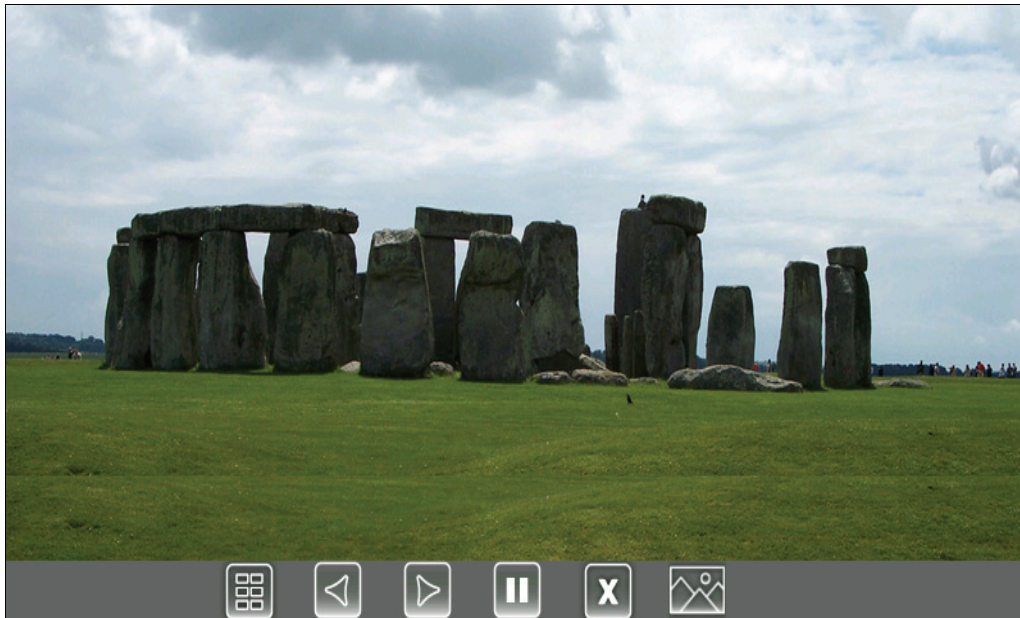

- From the idle screen, tap  > **Picture Frame**.
- Tap  > **Features** > **Removable Storage Media** > **Picture Frame**.
- Press , and then tap the **Picture Frame** icon.

Your pictures will display one-by-one (like a slide show). Six keys display beneath your pictures.

The following figure shows a picture that is stored on a USB flash drive, and the six keys that display so you can display the pictures on your USB flash drive as thumbnails, one-by-one, or one picture only.

The sixth key, , allows you to set the picture as the background image for your phone (see [Setting a Picture on Your USB Flash Drive as the Background Picture on Your Phone](#) on page 2-16).



- To view thumbnails of your pictures, tap .
- To go to the previous picture, tap .
- To go to the next picture, tap .
- To pause and display the current picture only, tap . To display the pictures one-by-one again, tap .
- To stop displaying the pictures and return to the idle screen, tap . The pictures will not display again until you access the Picture Frame feature again (unless you have a screen saver set up, or you enable one).
- To set the picture that currently displays as the background picture for your phone, tap .

Note

To remove the six keys from the touch screen, tap the touch screen. To display the six keys again, tap the touch screen again.

Setting a Picture on Your USB Flash Drive as the Background Picture on Your Phone

You can set a picture that is stored on your USB flash drive as the background picture on your phone. When you set one of your pictures as the background picture, the picture will display as “Local File” in the Backgrounds list (see [Updating the Background Picture](#) on page 2-8).



Before you can set a picture on your USB flash drive as the background picture, confirm the following:

- The picture is on the USB flash drive, and the USB flash drive is attached to your phone.
- You have specified the folder the picture is in on your USB flash drive.





For more information on placing a picture on your USB flash drive, connecting the USB flash drive to your phone, and specifying a folder, see [Setting Up a Screen Saver](#) on page 2-9 .

To set a picture on your USB flash drive as the background picture on your phone:

1. Do one of the following:

- From the idle screen, tap  > **Picture Frame**.
- Tap  > **Features** > **Removable Storage Media** > **Picture Frame**.
- Press , and then tap the **Picture Frame** icon.

Your pictures will display, one-by-one.

2. To set a picture as the background picture for your phone, wait for the picture to display, and then tap . Or, press  or  to display the picture, and then tap .

To re-set the default background image, see [Updating the Background Picture](#) on page 2-8, but select **Default** for the background image.

Changing the Backlight Intensity

Backlight intensity on the phone has three components:

- Backlight On
- Backlight Idle
- Maximum Intensity

You can modify the Backlight On intensity and the Backlight Idle intensity separately. You can select high, medium, low, and off levels for both.

When you modify the Maximum Intensity, you modify the entire backlight intensity scale. For example, if you decrease the Maximum Intensity, the low, medium, and high levels for both Backlight On and Backlight Idle intensities decrease.

The Backlight On intensity applies to following events:

- Any key press
- Incoming calls
- Ending a call, holding a call, resuming a call by the other party
- A voice message received

If you do not press any keys on the phone, after 20 seconds of the backlight turning on, the backlight dims (or changes) to medium in the following cases:

- A call is in progress
- A call is on hold
- There is an incoming call (ringing)
- There is an outgoing call (ringing back)
- Any menu shows on the display

In all other cases, the Backlight Idle intensity applies.

To modify the backlight intensity:

1. Tap  > **Settings** > **Basic** > **Backlight Intensity**.
2. Tap **Backlight On Intensity**.

The Backlight On Intensity screen displays.



3. Tap the intensity you want, tap the **Select** soft key, and then tap the **Save** soft key.

The default level is High.

4. Tap Backlight Idle Intensity.

The Backlight Idle Intensity screen displays.





5. Tap the intensity you want, tap the **Select soft key, and then tap the **Save** soft key.**

The default level is Low.

6. Tap Maximum Intensity.

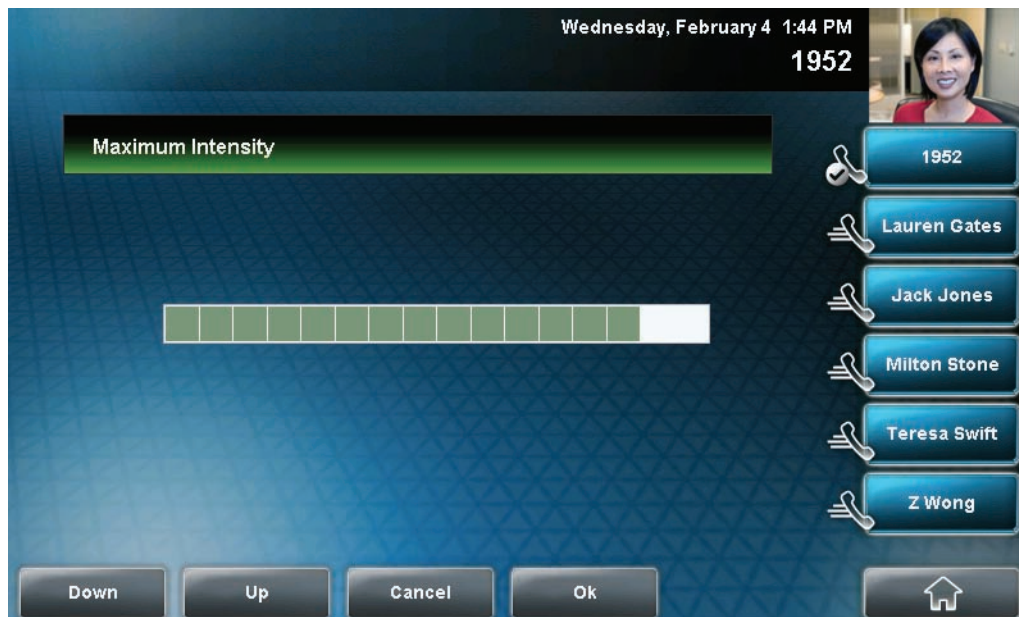
The Maximum Intensity screen displays.



7. Tap the **Up** or **Down** soft keys to increase or decrease the backlight intensity.
8. Tap the **Ok** soft key.
9. Tap  to return to the idle screen.

Updating the Ring Tone

You can select from many different ring types to distinguish lines or to distinguish your phone from your neighbor's phone. You can also set distinctive incoming ring tones for contacts in your local directory so you can identify callers when your phone rings.

Selecting a Ring Tone for Your Phone

You can choose a distinctive ring tone for your phone to identify if when it rings. Or, you can choose distinctive ring tones for different lines on your phone.

To select a ring tone for your phone or a specific line:

1. Tap  > **Settings** > **Basic** > **Ring Type**.

The Ring Type screen displays.

(If multiple lines are configured on your phone, the Line Select screen displays instead, and you have to select the line to which to apply the ring type. Then, the Ring Type screen displays.)



2. Tap the ring type you want, and then tap the **Select** soft key. To hear the ring type before you change it, tap the **Play** soft key.

The default ring type is Low Trill.

3. Tap  to return to the idle screen.

Note

If you set up your phone with a silent ring, tap the ringing Line Key or the **Answer** soft key to answer the call. If your handset is off hook, the call is routed to the handset. If your handset is on hook, the call is routed to the speaker.

Setting Ring Tones for Contacts

Note

Your company's settings may override this feature. For more information, contact your system administrator.

You can set a distinctive ring tone for each contact in your Contact Directory so you can distinguish callers.

To set a distinctive ring tone for a contact:

1. Tap  > **Features** > **Contact Directory**.

The Directory screen displays.



2. Tap the contact for whom you want to assign a distinctive ring tone, and then tap the Edit soft key.

The Edit Contact screen displays.



3. Tap the **Ring Type** field, and then enter a number corresponding to one of the ring types available.

Note

To exit this screen and determine the number associated with a ring type, press the **Menu** key twice, and then tap **Settings > Basic > Ring Type**. Each ring type has a number associated with it.

4. Tap the **Save** soft key.
5. Tap  to return to the idle screen.

Disabling and Stopping Video

You can disable or stop the transmission of near-site video. However, you cannot disable or stop far-site video. If your phone receives far-site video, your phone always displays far-site video.

By default, your phone always transmits near-site video, unless you do the following:

- Stop the transmission of near-site video on a call-by-call basis. During a call, you can choose to start and stop video at any time. For more information, see [Handling Video Calls](#) on page 3-3.
- Disable your phone from automatically transmitting near-site video at the start of all calls. (If you disable your phone in this way, you still have the option to start and stop video during the call). For more information, see [Updating Video Settings](#), below.

If you stop or disable video,  will display next to near-site video.

The following figure shows what the touch screen looks like when you stop or disable video.



The following figure shows what the touch screen looks like when the far-site stops or disables video.

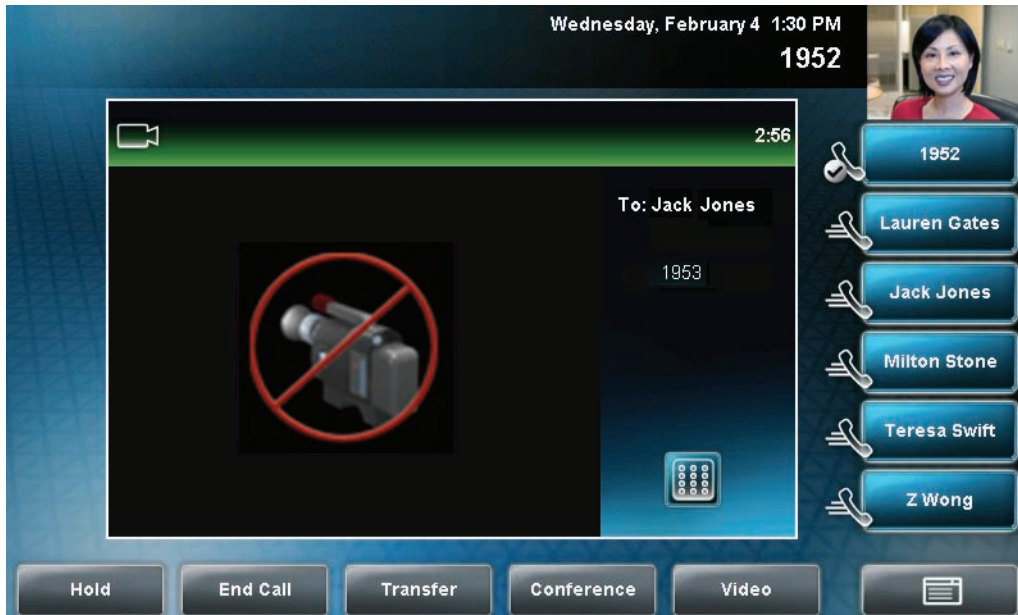

Note

Your system administrator can configure your phone so that your phone cannot transmit and receive video at all, even on a call-by-call basis.

Updating Video Settings

Video settings allow you to update:

- Video Call Settings – to enable or disable near-site video at the start of all calls, and to choose to display incoming video calls on the full screen or in the window in the center of the touch screen. See [Updating Video Call Settings](#) on page 2-25.
- Video Screen Mode – to change the way video appears in the window in the center of the screen and on the full screen. See [Updating the Way Video Displays in the Window in the Center of the Screen and on the Full Screen](#) on page 2-28.
- Local Camera View – to view full screen video with or without the PIP, and whether the PIP should display next to, or over, the full screen video. See [Updating the Way the PIP displays](#) on page 2-29.
- Camera Settings – to change the clarity of near-site video, including the brightness, contrast, and sharpness. See [Updating Camera Settings](#) on page 2-32.

Note

When you adjust video settings, the changes will affect the next call.

Updating Video Call Settings

You can customize video in these ways:

- Disable video so that your phone does not transmit near-site video, for all calls.
- Choose to view all incoming video calls using a full screen layout.

To change the video settings:

1. Tap  > **Settings** > **Basic** > **Video** > **Video Call Settings**.

The Video Call Settings screen displays.

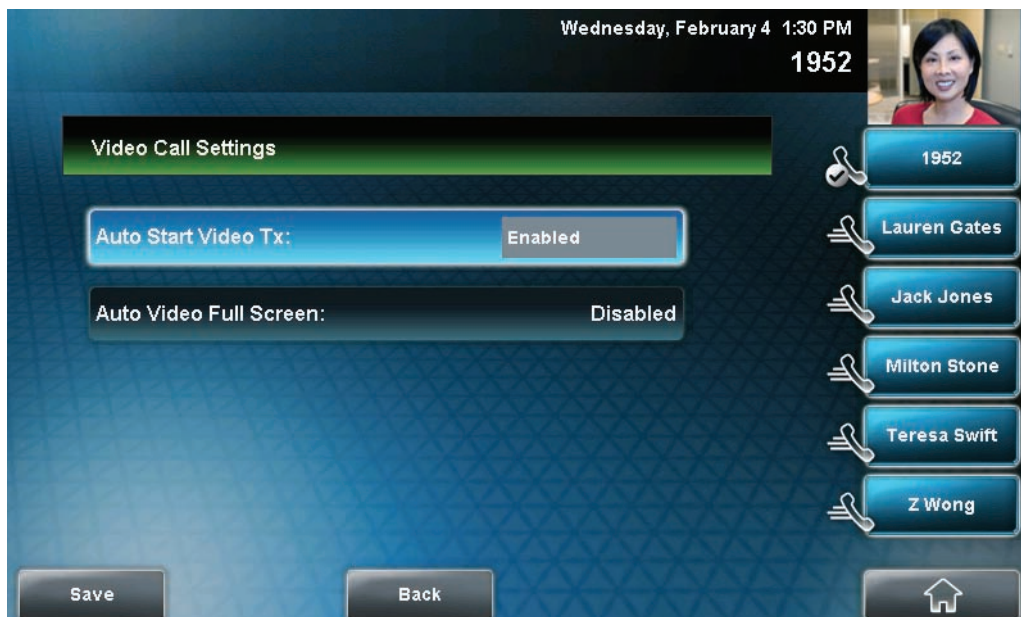

2. Tap, and then adjust, the following video settings:

– Audio Start Video Tx

This setting automatically enables your phone to transmit video at the start of all calls. When disabled, your phone will not automatically transmit video at the start of all calls, and  will display next to near-site video during video calls.

The following figure shows what the touch screen looks like during a video call when the setting is disabled.



The following figure shows what the touch screen looks like when the far site has disabled the setting.

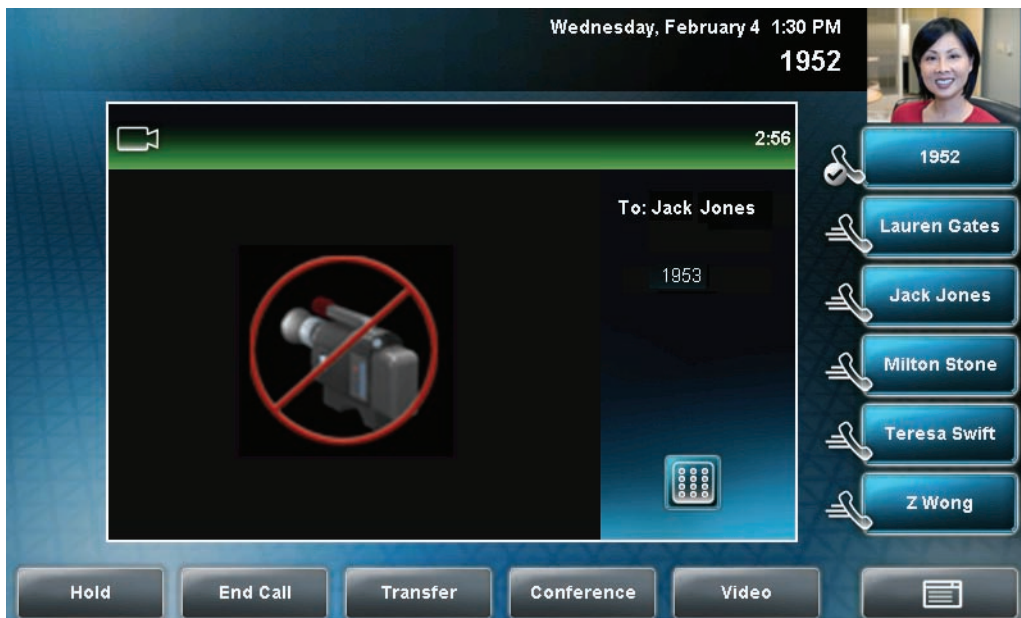

To enable or disable this setting, tap the Auto Start Video Tx field's highlighted box. From the drop-down list, tap **Enabled** or **Disabled**.

The default setting is Enabled.

Note

If you disable this setting, you can still transmit video on a call-by-call basis. To transmit video during a specific call, see [Handling Video Calls](#) on page 3-3. However, your phone will not automatically transmit video at the start of the next call, unless you enable the setting beforehand.

If you enable or disable this setting, the change will affect the next call, not the current call.

– Auto Video Full Screen

This setting automatically enables your phone to display far-site video on the full screen when you answer a call from a video endpoint. When you disable this setting, far-site video will display in the window in the center of the touch screen.

To enable or disable this setting, tap the field name, and then tap the field's highlighted box. From the drop-down list, tap **Enabled** or **Disabled**.

The following figure shows what displays when you enable your phone to display far-site video on the full screen when you answer a call from a video endpoint. (Depending on the video endpoint, you may or may not see black bars.)



Updating the Way Video Displays in the Window in the Center of the Screen and on the Full Screen

Adjust the appearance of video images so that the video that displays in the window in the center of the touch screen, and on the full screen, display normal, full, or cropped images.

Note

Depending on the video endpoint, black bars may appear on the top, bottom, or sides of the video image.

To update the way video displays in the window in the center of the screen and on the full screen:

1. Tap  > **Settings** > **Basic** > **Video** > **Video Screen Mode**.

The Video Screen Mode screen displays.



2. Tap, and then adjust the following settings:

– **Video Screen Mode (Window)**

Adjusts the video image that displays in the window in the center of the touch screen. You can select these settings:

Normal – The video image is displayed using correct proportions. If necessary, black bars appear on the top, bottom, or sides of the window to maintain the correct aspect ratio.

Full – The video image is stretched to fill the window.

Crop – Black bars do not appear, and the video image is re-sized to maintain the correct aspect ratio. Any parts of the image that do not fit within the window are cropped.

To select the setting you want, tap the field name, and then tap the field's highlighted box. From the drop-down list, tap the setting you want.

The default setting is Normal.

– **Video Screen Mode (Full Screen)**

Adjusts the video image that displays on the full screen. You can select these settings:

Normal – The video image is displayed using correct proportions. If necessary, black bars appear on the top, bottom, or sides of the touch screen to maintain the correct aspect ratio.

Full – The video image is stretched to fill the touch screen.

Crop – Black bars do not appear, and the video image is re-sized to maintain the correct aspect ratio. Any parts of the image that do not fit within the touch screen are cropped.

To select the setting you want, tap the field, and then tap the field's highlighted box. From the drop-down list, tap the setting you want.

The default setting is Normal.

3. Tap the **Save** soft key.

Updating the Way the PIP displays

You can update the way the PIP displays. For example, when you are in full screen mode (i.e., viewing the far or near site on the full screen), you can disable the PIP so the PIP doesn't display. When you are in full screen mode, you can also enable the PIP to display next to ("side-by-side" mode), rather than over ("PIP" mode), the full screen video.

The following figure shows the PIP disabled in full screen mode. (Depending on the video endpoint, you may or may not see black bars.)



The following figure shows the PIP when it displays next to (“side-by-side” mode), rather than over, full screen video.



The following figure shows the PIP when it displays over (“PIP” mode), rather than next to, full screen video. (Depending on the video endpoint, you may or may not see black bars.)



To update the way the PIP displays:

1. Tap  > Settings > Basic > Video > Local Camera View.
The Local Camera View screen displays.

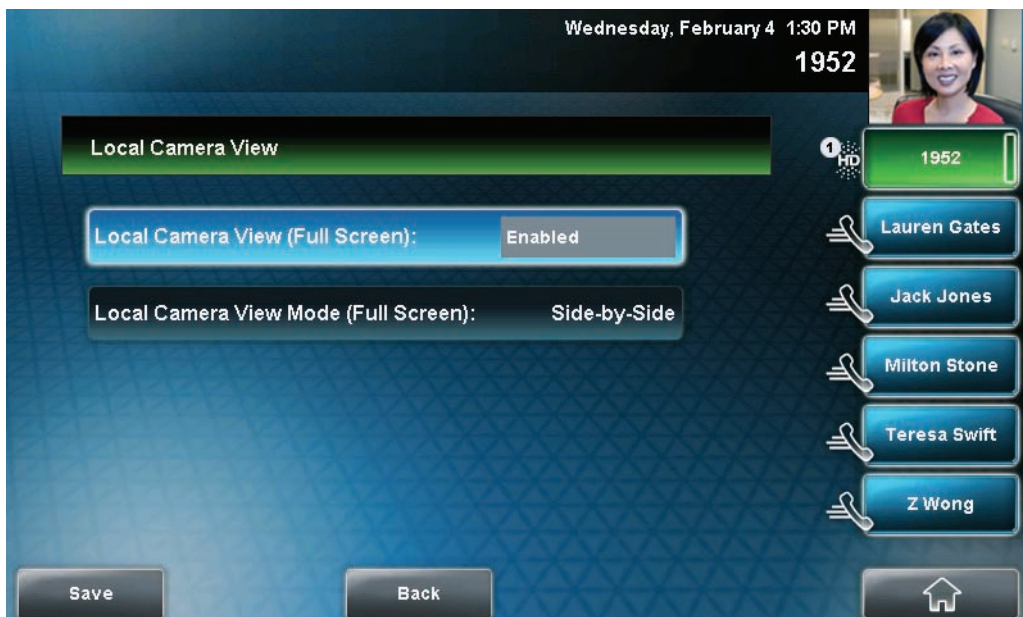

2. Tap, and then adjust the following settings:

– **Local Camera View (Full Screen)**

Enables or disables the PIP from displaying when you view the near or far site on the full screen.

To select the setting you want, tap the field, and then tap the field's highlighted box. From the drop-down list, tap **Enabled** or **Disabled**.

The default setting is Enabled.

– **Local Camera View Mode (Full Screen)**

Sets whether you want the PIP to display over or next to full screen video.

You can select these settings:

Side-by-Side – Displays the PIP next to (rather than over) the full screen video.

PIP – Displays the PIP over the full screen video.

The default setting is side-by-side.

Note

If you select "PIP," as well as update the way full screen video displays (by choosing "Full" or "Crop" mode), the full screen video will display on the entire screen (without black sidebars). To choose "Full" or "Crop" mode, see [Updating the Way Video Displays in the Window in the Center of the Screen and on the Full Screen](#), above.

To select the setting you want, tap the field, and then tap the field's highlighted box. From the drop-down list, tap **Side-by-Side** or **PIP**.

3. Tap the **Save** soft key.

Updating Camera Settings

You can change the clarity of near-site video, including the brightness, contrast, and sharpness levels of the video image. These settings affect how near-site video displays on your phone and on other phones.

Note

If you place your phone so that the camera faces a bright light source (for example, a bright window), you may need to increase the camera's brightness, contrast, and sharpness levels so the far site can see you better. To see how you will look to the far site, view the PIP.

To change the clarity of near-site video:

1. Tap  > **Settings** > **Basic** > **Video** > **Camera Settings**.

The Camera Settings screen displays.



2. Tap, and then adjust, the following camera settings:

Note

If your camera points to a bright light source, increase the brightness, contrast, and sharpness levels so the near site will be more clear.

- **Target Frame Rate** – sets how smooth near-site video displays.
Tap the **Up** or **Down** soft key to set the rate, and then tap the **Save** soft key.
You can set a rate between 5 (least smooth) and 30 (most smooth). The default rate is 25.
- **Brightness Level** – sets how bright near-site video will be.
Tap the **Up** or **Down** soft key to set the level, and then tap the **Save** soft key.
You can set a level between 0 (dimmiest) and 6 (brightest). The default level is 3.

- **Saturation Level**—sets how much color near-site video displays.

Tap the **Up** or **Down** soft key to set the level, and then tap the **Save** soft key.

You can set a level between 0 (lowest) and 6 (highest). The default level is 3.

- **Contrast Level**—sets the difference in brightness between the light and dark areas of near-site video.

Tap the **Up** or **Down** soft key to set the level, and then tap the **Save** soft key.

You can set a level between 0 (no contrast increase) and 4 (noise reduction contrast). The default level is 0.

- **Sharpness Level**—sets the clarity of detail in near-site video.

Tap the **Up** or **Down** soft key to set the level, and then tap the **Save** soft key.

You can set a level between 0 (lowest) and 6 (highest). The default level is 3.

- **Flicker Avoidance**—adjusts the flickering (caused by AC power) of near-site video captured by the camera sensor.

Tap the **Select Environment** field's highlighted box. From the drop-down list, tap **Auto** (to automatically detect flicker), **50 Hz** (flicker avoidance for Europe and Asia), or **60 Hz** (flicker avoidance for North America). Then, tap the **Save** soft key.

The default is Auto.

Updating Power Saving Settings

Your phone is set up with a power-saving mode that turns off the touch screen to conserve energy. Your phone enters power-saving mode after it has been idle for a certain period of time and its camera doesn't detect motion. Your phone will not enter power-saving mode if it detects motion (for example, if you are near the phone), even if the phone has been idle for the period of time you specified.

You can configure the period of time that the phone is idle ("idle timeout") before the touch screen turns off (if the camera does not detect motion). You can configure different idle timeouts for office hours and off hours (evenings and weekends).

During off hours, the touch screen displays “Off Hours Mode” on the status bar.

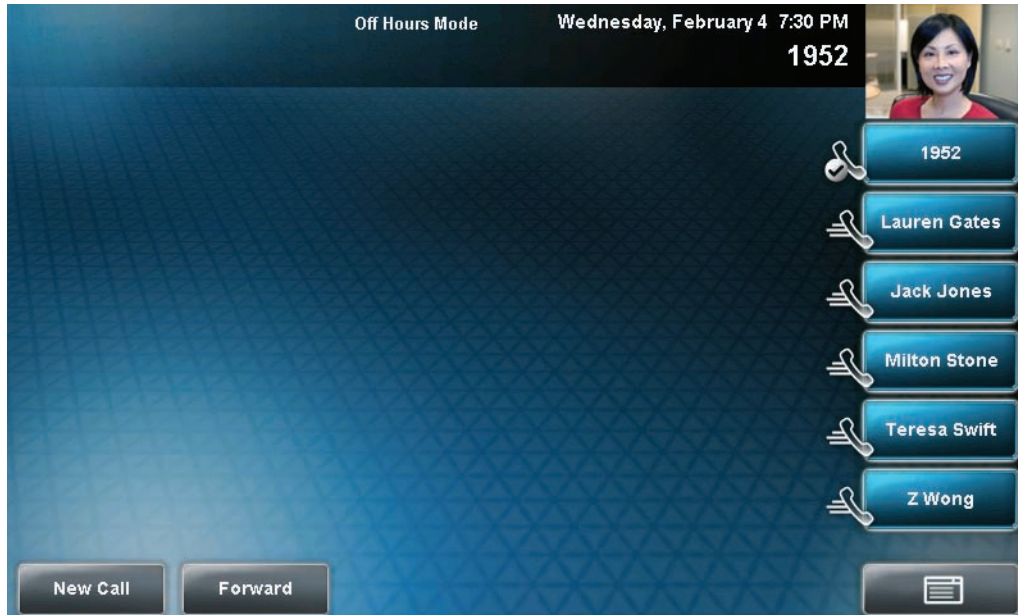

During power-saving mode, the LED on the top-right of the phone slow-blinks red to indicate that the phone has power and is ready to use, but is in power-saving mode. Your phone will exit power-saving mode if the camera detects motion or a phone event occurs (for example, an incoming call or message).

If a screen saver is enabled on your phone, power-saving mode will still occur. For example, if a screen saver is set up to display after the phone is idle for five minutes, and power-saving mode is set up to turn off the touch screen after the phone is idle for 15 minutes, the touch screen will turn off 10 minutes after the screen saver starts (if the camera doesn't detect motion).

The power-saving settings you can update are:

- Office Hours – When you start work and how long you are in the office each day.
- Timeouts – The period of time the phone should be idle before the touch screen turns off.
- User Detection – The sensitivity of the camera to detect motion so that the phone can enter power-saving mode (if it doesn't detect motion) or exit power-saving mode and display the idle screen (if it detects motion).

Updating Office Hours

Update your office hours so the phone will know when you are in the office. Your office hours determine when the phone applies certain timeouts and when the camera should be most sensitive at detecting your presence. When you update your office hours, you specify when you start, and how long you work each day (Monday to Friday).

To update your office hours:

1. Tap  > **Settings** > **Basic** > **Power Saving** > **Office Hours** > **Start Hour**.

The Start Hour screen displays.

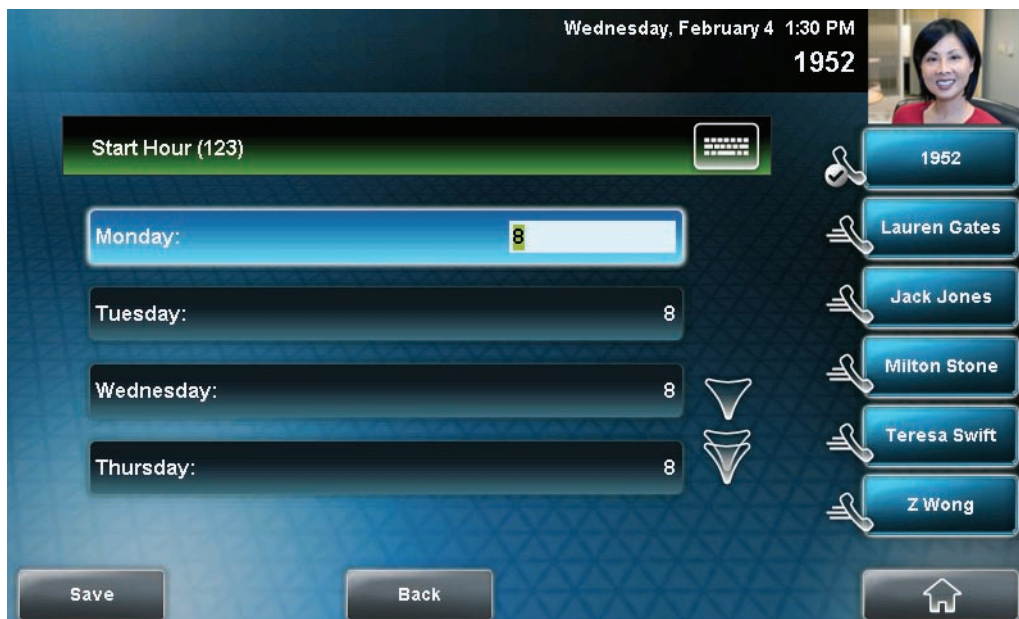

2. Tap the day(s) of the week you want to update, and then enter your start time(s).

Enter a start time using the 24-hour clock. You can enter a start time from 0 to 23. The default start time is 8.

3. Tap the **Save** soft key.

4. Tap **Duration**.

The Duration screen displays.

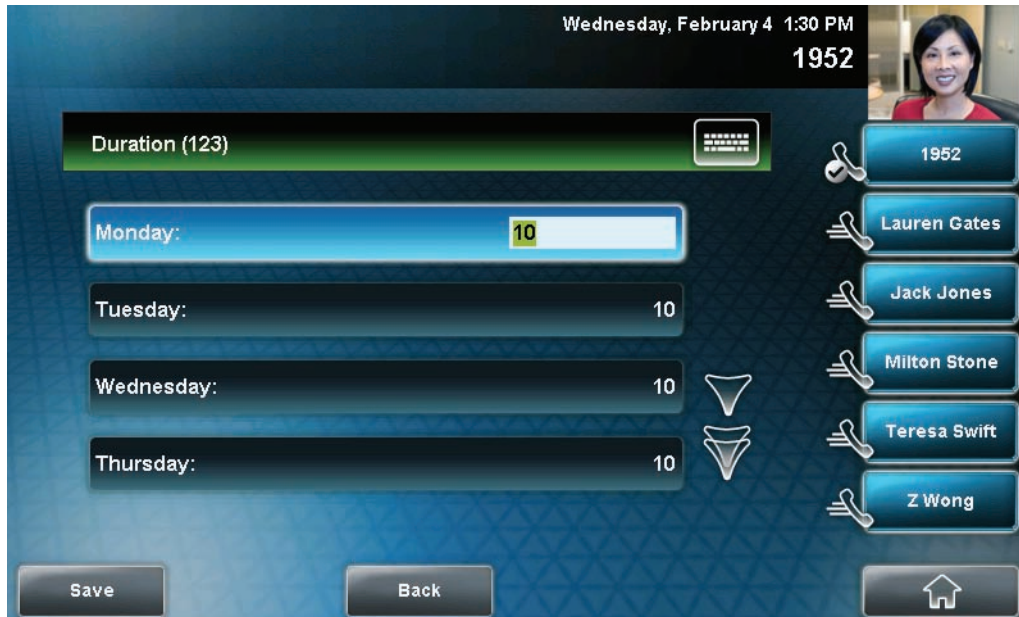

- Tap the day(s) of the week you want to update, and then enter the number of hours you work for a particular day.

You can enter a duration of 0 to 12 hours per day. The default duration is 10 hours per day (for Monday to Friday) and 0 hours per day (for Saturday and Sunday).

- Tap the **Save** soft key.

Updating Timeouts

You can update the period of time the phone will be idle before the touch screen turns off (if the camera doesn't detect motion). You can specify different timeouts for office hours (Office Hours Idle Timeout) and non-office hours (Off Hours Idle Timeout). By default, the Office Hours Idle Timeout is much longer than the Off Hours Idle Timeout.

You can also specify a separate timeout period that applies after you press a key or soft key on the phone (User Input Idle Timeout). You may choose to set a higher User Input Idle Timeout (than the Office Hours and Off Hours Idle Timeouts) so that when you are actively using the phone, power-saving mode won't initiate as often.

Note

If you press a key or tap a soft key (user input) on your phone, the idle timeout period that applies (User Input Idle Timeout or Office Hours/Off Hours Idle Timeout) will be the timeout with the highest value.

To update timeouts:

1. Tap  > **Settings** > **Basic** > **Power Saving** > **Timeouts**.

The Timeouts screen displays.



2. For the **Office Hours Idle Timeout** field, enter the number of minutes the phone should wait after being idle (during office hours) before starting power-saving mode.

You can enter a number between 1 minute and 600 minutes. The default is 10 minutes.

3. Tap **Off Hours Idle Timeout**, and then enter the number of minutes the phone should wait after being idle (during off-hours) before starting power-saving mode.

You can enter a number between 1 minute and 10 minutes. The default is 1 minute.

4. Tap **User Input Idle Timeout**, and then enter the number of minutes the phone should wait after being idle after a key press (during office hours or off-hours) before starting power-saving mode.

You can enter a number between 1 minute and 10 minutes. The default is 10 minutes.

5. Tap the **Save** soft key.

Updating User Detection Settings

You can specify how sensitive the camera should be at detecting motion. If the camera detects motion (for example, if you are near the phone), your phone will not initiate power-saving mode, even if an idle timeout has been reached.

If the camera detects motion, power-saving mode will terminate and the idle screen will display. If the camera sensitivity is high (five or higher), the phone will display the idle screen when you are near the phone. If the camera sensitivity is low (between one and four), you will have to wave your hand at the camera for the idle screen to display. By default, camera sensitivity is set higher during office hours. If you want, you can disable the user detection feature altogether.

Note

The camera will detect any source of motion in front of it, not just a person or people nearby. For example, the camera will detect flying objects or rapidly-changing light conditions. Therefore, even if you are away from the phone, your phone may detect other sources of motion, and won't initiate power-saving mode.

In addition, since your phone's camera detects motion, if you close the camera shutter, point the camera at the ceiling, or set the camera sensitivity to 0, the phone will not detect your presence (even if you are nearby).

To update user detection settings:

1. Tap  > Settings > Basic > Power Saving > User Detection.

The User Detection screen displays.

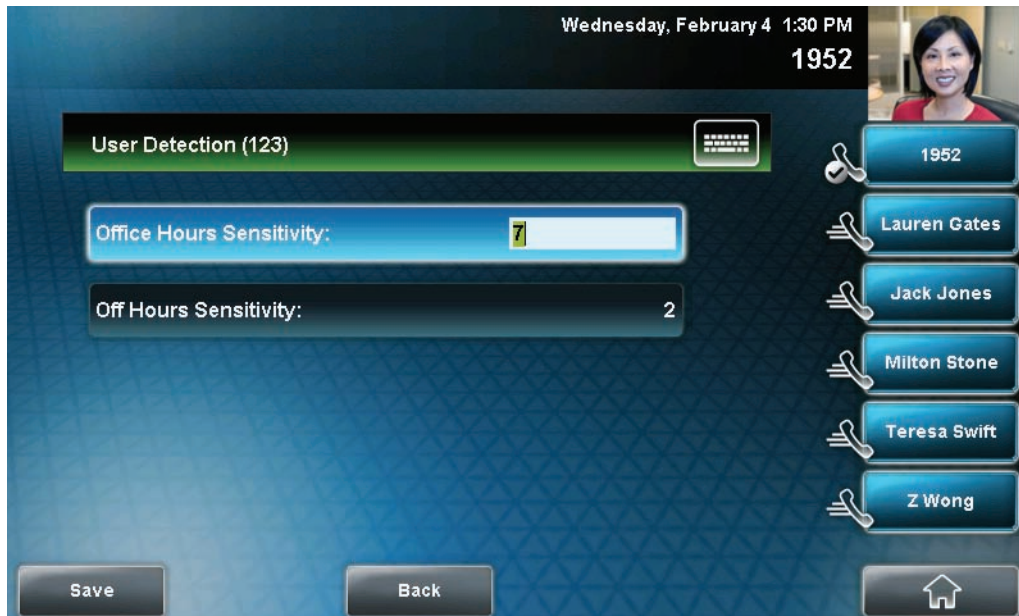

2. For the **Office Hours Sensitivity** field, enter how sensitive you want the camera to be while you are in your office.

You can enter a number between 0 (no sensitivity) and 10 (high sensitivity). The default sensitivity is 7.

If you set a sensitivity between 1 and 4, you will have to wave your hand at the camera to exit power-saving mode. As well, power-saving mode may be initiated when you are in your office, but not close to your phone. (If you enter 0, the user detection feature is disabled and you will have to press a key on your phone to exit power-saving mode.)

3. Tap **Off Hours Sensitivity**, and then enter how sensitive you want the camera to be while you are not in the office.

You can enter a number between 0 (no sensitivity) and 10 (high sensitivity). The default sensitivity is 2.

If you set a sensitivity between 1 and 4, you will have to wave your hand at the camera to exit power-saving mode. As well, power-saving mode may be initiated when you are in your office, but not close to your phone. (If you enter 0, the user detection feature is disabled and you will have to press a key on your phone to exit power-saving mode.)

4. Tap the **Save** soft key.

Muting the Microphone

During a call (including a conference call), press . The Mute

button glows red, and  displays next to near-site video. The other party (or parties) cannot hear you.



Microphone Mute applies to all modes: Handset, Headset, and Speakerphone. You can still hear all other parties while mute is enabled.

To turn off Microphone Mute, press  again. The red light



behind the Mute button turns off, and  no longer displays next to near-site video.

Adjusting the Volume

To adjust the speaker volume:

>> During a call, press either  or .

To adjust the ringer volume:

>> When the phone is in the idle state, press either  or .

Note

To conform to regulatory requirements, handset and headset volume will return to a preset level after each call, but your system administrator can change this. Speakerphone volume settings will be maintained across calls.

Using Call Lists

Your phone maintains lists of missed, received and placed calls. Each list can hold up to 100 entries.

If you miss one or more calls, the status bar will display an icon, , with a counter indicating the number of new missed calls you have. To view information about the missed call(s), tap the icon on the touch screen, or navigate (see [Viewing Call Lists](#) on page 2-42), to your Missed Calls list. After you view the missed calls, the icon on the touch screen disappears.

The following figure shows the missed calls icon on the touch screen.

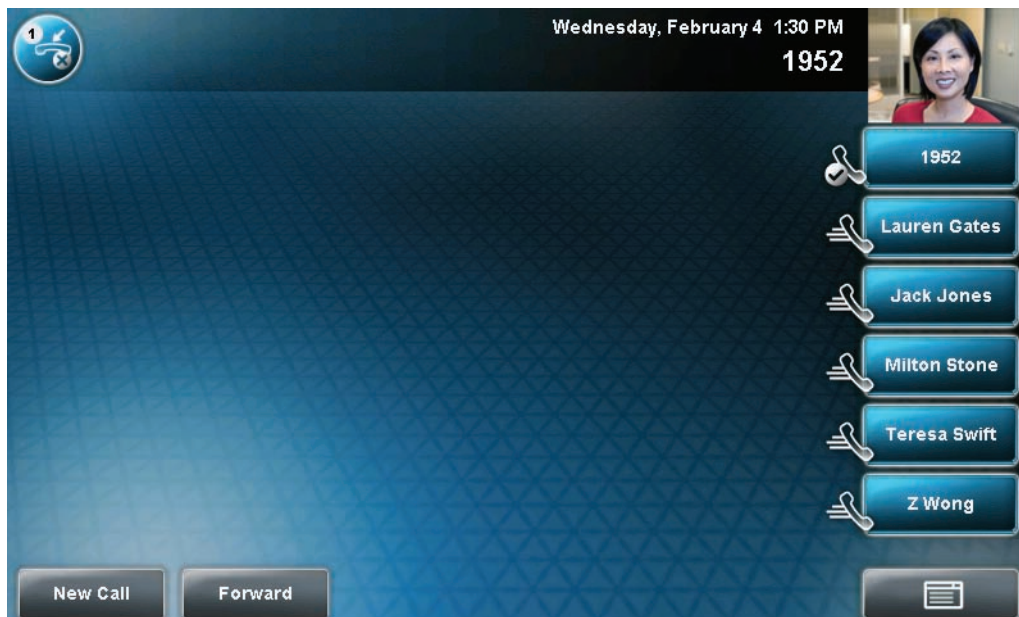

Viewing Call Lists

You can access any call list from the Call Lists menu, or you can quickly access missed calls from the idle screen.

To view a call list:

>> Do one of the following:

- Tap  > **Features** > **Call Lists** > **Missed Calls, Received Calls, or Placed Calls**.

or

- From the idle screen, use these shortcuts:
 - To view the received calls list, press the **Left** arrow key.
 - To view the missed calls list, press the **Down** arrow key. Or, if you haven't viewed a recently-missed call yet, tap the missed call icon,



, that displays on the status bar on the touch screen.

- To view the placed calls list, press the **Right** arrow key.

Managing Call Lists

You can clear all the records in a call list, or just one record. You can also choose a record in a list and return the call, store the call details in your local Contact Directory, or view detailed information about the particular call.

To manage a call list:

1. Tap  > **Features** > **Call Lists**.

The Call Lists screen displays.



2. Do one of the following:

- To clear the records in a call list, tap **Clear**, and then tap either **Missed Calls**, **Received Calls** or **Placed Calls**.

A message displays indicating that the call list is cleared. For example, "Missed Calls Cleared!"

Note

To manually clear all calls in all call lists, restart the phone. See [Restarting Your Phone](#) on page 4-33.

- To view and manage a call list, tap either **Missed Calls**, **Received Calls** or **Placed Calls**. Your call list information displays.

To manage your call list, tap one of the calls in the list. You can do the following:

- To place the call, tap the **Dial** soft key.
- To edit the phone number (if necessary) before you place the call or store the call details in your Contact Directory, tap the **Edit** soft key.
- To return to the call list, tap the **Back** soft key.
- To remove the call from the list, tap the **Clear** soft key.

- To store the contact in your local Contact Directory, tap the **Save** soft key.
 - To view information about the call, such as the phone number, the time and duration of the call, and the name of the caller, tap the **Information** soft key.
3. Tap  to return to the idle screen.

Managing Contacts

You can store a large number of contacts in your phone's local Contact Directory. Contact your system administrator for the exact number.

You can dial and search for contacts in this directory. You may be able to add, edit, and delete contacts. Contact your system administrator to see if you have read-only access to your local Contact Directory, or if you can update it.

If your system administrator sets up Corporate Directory on your phone, you may have read-only access to portions of your Corporate Directory. Your system administrator determines which contacts you can see. You can search for contacts in the Corporate Directory, and add contacts from the Corporate Directory to your local Contact Directory. For more information, see [Searching for Contacts in a Corporate Directory](#) on page 2-55 and [Adding Contacts to Your Contact Directory from a Corporate Directory](#) on page 2-52.

To view your local Contact Directory:

>> Tap  > **Features** > **Contact Directory**.

The Directory screen displays, listing all the contacts in your directory.

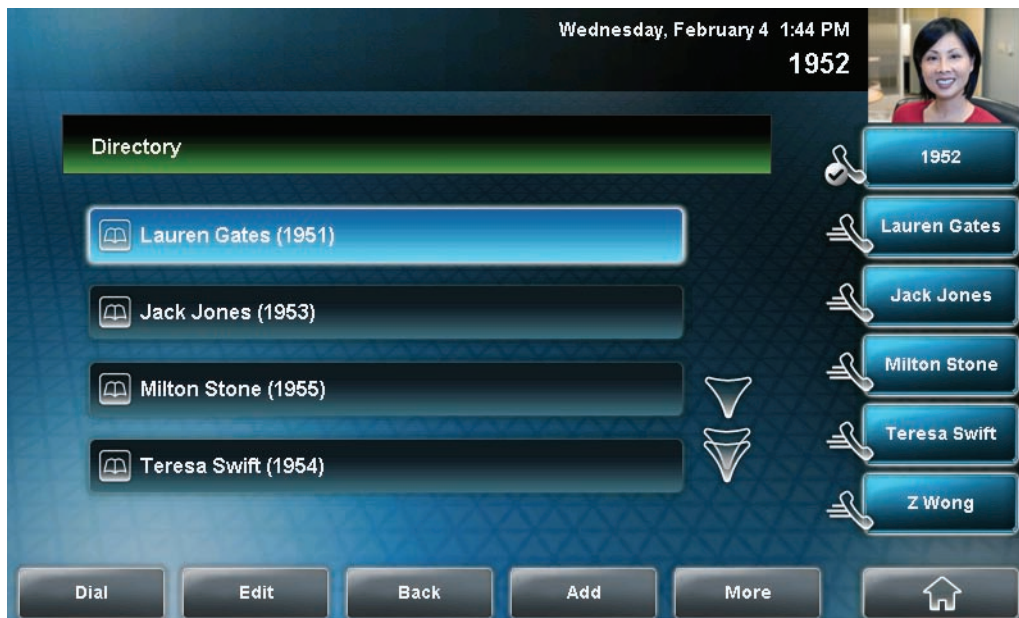

To view your Corporate Directory:

>> Tap  > Features > Corporate Directory.

The Corporate Directory screen displays, listing all the contacts in your Corporate Directory.

The following figure shows a sample Corporate Directory.

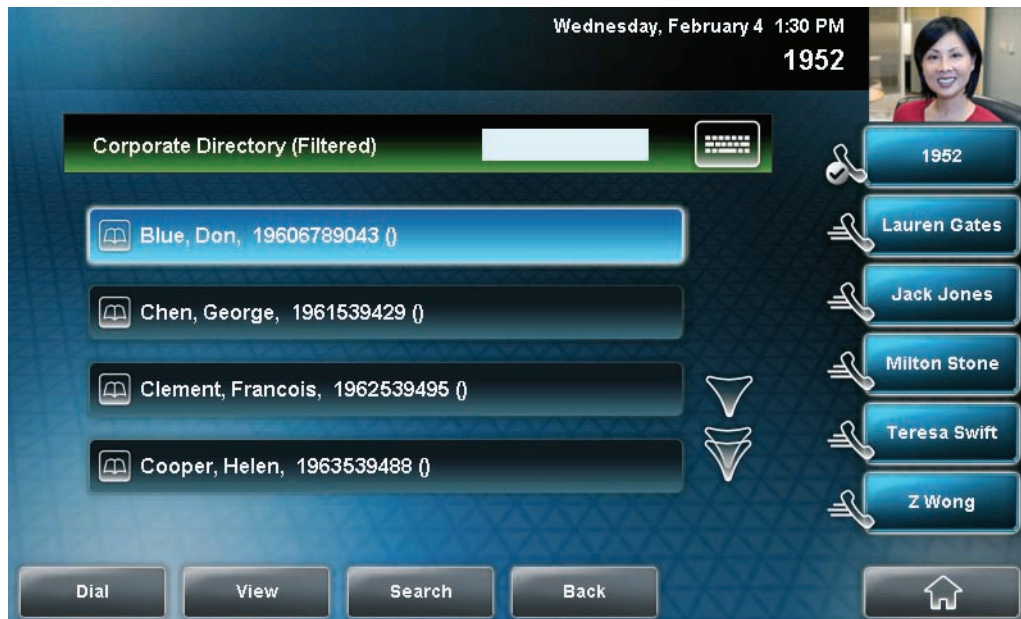

You cannot update the contacts in your Corporate Directory. You can only search for and dial contacts, and add contacts from your Corporate Directory to your local Contact Directory.

Adding Contacts to Your Local Contact Directory

You can add contacts to your local Contact Directory in the following ways:

- Manually (if you have permission to update your local Contact Directory)
- From a call list
- From a Corporate Directory (if this is set up on your phone)

Note

You cannot update Corporate Directory from your phone.

Adding Contacts Manually

You can update your local Contact Directory manually, instead of importing contact information from a call list or a Corporate Directory.

To add a contact manually:

1. Tap  > Features > Contact Directory.

The Directory screen displays.



2. To add a contact to your phone's database, tap the **Add** soft key. The Add To Directory screen displays.



3. Enter the contact information. Enter the following information:

Note

Your phone may not display all the following fields (for example, the Watch Buddy and Block Buddy fields). For more information, see your system administrator.

- (Optional.) In the **First Name** field, enter the first name of the contact (see [Entering Data and Editing Fields](#) on page 1-27.)
You can enter a maximum of 32 characters.
- (Optional.) Tap the **Last Name** field, and then enter the last name of the contact (see [Entering Data and Editing Fields](#) on page 1-27.)
You can enter a maximum of 32 characters.
- (Required.) Tap the **Contact** field, and then enter the contact's phone number.
You can enter a maximum of 32 characters. The phone number must be unique, and must not already exist in the directory. If you save an entry with a non-unique phone number, the entry will not be saved.
- (Optional.) Tap the **Speed Dial Index** field, and then update the speed dial index number.
The speed dial index number is automatically assigned to the next available index value. If you want, you can change the speed dial index value. The speed dial index value can be any value between the next available number and a maximum value of 9999.

If you assign a speed dial index number that is already taken, the message “Speed dial index already exists” displays.

Contacts with a speed dial index number can be automatically assigned to a Speed Dial Key for one-touch dialing. For more information, see [Managing Speed Dial Keys](#) on page 3-38.

- (Optional.) Tap the **Label** field, and then enter a label for the contact. You can enter a maximum of 32 symbols, letters, or numbers.

If you specify a label, the label will be the first item that displays for the contact in the Contact Directory and on the Speed Dial Information screen (before the contact’s first and last names, if specified). The label will also display on the contact’s Speed Dial Key.

In the following figure, the label “Manager” has been assigned to Lauren Gates. As a result, Lauren Gates’ Speed Dial Key displays “Manager” instead of “Lauren Gates.”

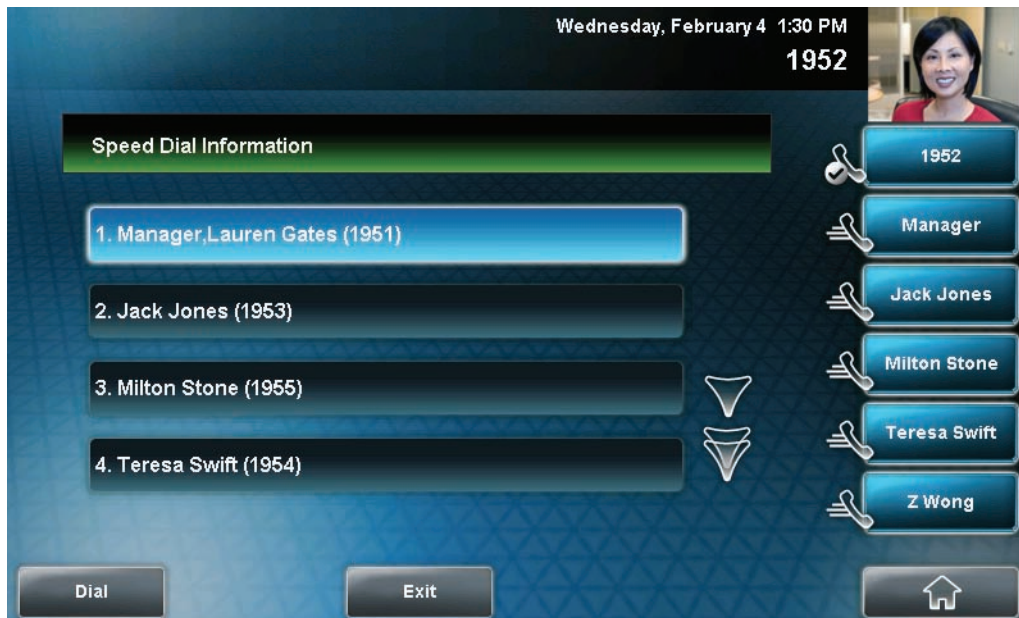

- (Optional.) Tap the **Ring Type** field, and then enter the number that corresponds to the ring type you want to use for the contact.

To find the number associated with a ring type, see [Updating the Ring Tone](#) on page 2-20.

- (Optional.) Tap the **Divert Contact** field, and then enter the phone number of the third party to which you want this contact’s calls sent.

You can enter a maximum of 32 characters.

- (Optional.) Tap the **Auto Reject** field, and then tap the field's highlighted grey box. From the drop-down list, tap **Enabled** or **Disabled**. (The default setting is **Disabled**.)

If you set the Auto Reject field to enabled, each time the contact calls, the call will be directed to your voice and video mail system (if one is set up).

Note

If you do not have a voice and video mail system set up, enabling the Auto Reject field will have no effect. Each time the contact calls, your phone will ring (unless you choose to divert the contact's calls, or enable call forwarding or Do Not Disturb on your phone).

- (Optional.) Tap the Auto Divert field, and then tap the field's highlighted grey box. From the drop-down list, tap **Enabled** or **Disabled**. (The default setting is **Disabled**.)

If you set the Auto Divert field to enabled, each time the contact calls, the call will be directed to the third party you specified in the Divert Contact field.

- (Optional.) Tap the Watch Buddy field, and then tap the field's highlighted grey box. From the drop-down list, tap **Enabled** or **Disabled**. (The default setting is **Disabled**.)

If you set the Watch Buddy field to enabled, you can monitor the contact's status. For more information on monitoring status, see [Using Buddy Lists](#) on page 4-6.

- (Optional.) Tap the Block Buddy field, and then tap the field's highlighted grey box. From the drop-down list, tap **Enabled** or **Disabled**. (The default setting is **Disabled**.)



If you set the Block Buddy field to enabled, the contact cannot monitor your status. For more information on monitoring status, see [Using Buddy Lists](#) on page 4-6.

4. Tap the **Save** soft key.
5. Tap  to return to the idle screen.

Adding Contacts from Call Lists

You can save call information from a call list to your local Contact Directory. The contact's first and last names (if available) and contact number are saved.

To add a contact to the local Contact Directory from a call list:

1. Do one of the following:
 - To select a call list, tap  > **Features** > **Call Lists** > **Missed Calls**, **Received Calls**, or **Placed Calls**.
 - or
 - From the idle screen, press the **Left** arrow key, the **Down** arrow key, or the **Right** arrow key to quickly view a call list.
2. If the call with the call information you want to save is not already highlighted, tap the call.
3. To save the caller to your Contact Directory, tap the **Save** soft key.
The message "Saved" displays.
If the contact already exists in your Contact Directory, "Contact already exists" displays.
4. Tap  to return to the idle screen.

Note

You may want to go to the Contact Directory to see if the contact was saved correctly and to add any missing contact information. To view your Contact Directory, see [Managing Contacts](#) on page 2-44. To update missing contact information, see [Adding Contacts Manually](#) (step 3) on page 2-47.

Adding Contacts to Your Contact Directory from a Corporate Directory

You can save any contact listed in your Corporate Directory (if it is set up on your phone) to your local Contact Directory. The contact's first and last names (if available) and contact number are saved.

To add a contact to your local Contact Directory from a Corporate Directory:

1. Tap  > Features > Corporate Directory.

The Corporate Directory screen displays.

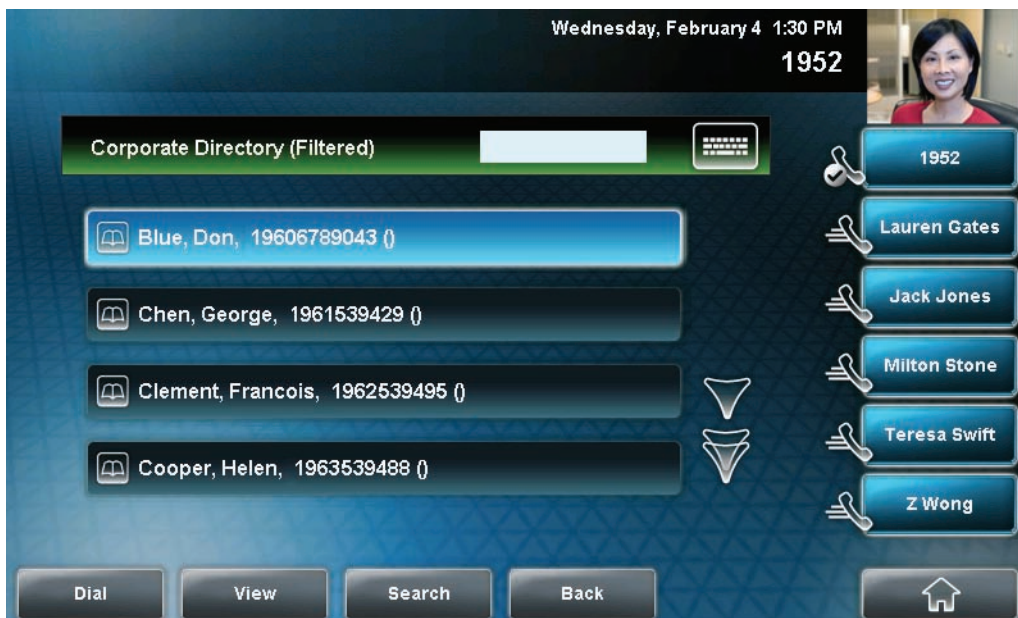



2. Search for the contact.

For information on how to search for a contact, see [Searching for Contacts in a Corporate Directory](#) on page 2-55.

- If the contact you want to save is not already highlighted, tap the contact's entry.

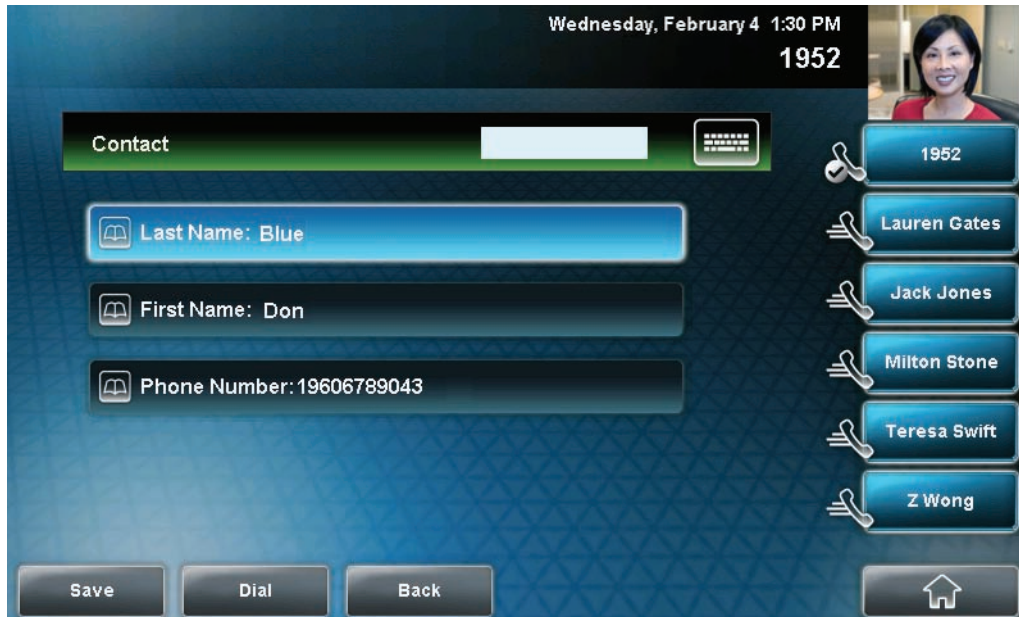
The Contact screen displays.



- To save the contact to the local Contact Directory, tap the **Save** soft key. "Saved" displays on the screen. Only the first name, last name, and phone number are saved.
If the contact already exists in your local Contact Directory, "Contact already exists" displays.
- Tap  to return to the idle screen.

Note

You may want to go to the Contact Directory to see if the contact was saved correctly and to add additional contact information. To view your Contact Directory, see [Managing Contacts](#) on page 2-44. To update contact information, see [Adding Contacts Manually](#) (step 3) on page 2-47.

Searching for Contacts

You can search for contacts in your local Contact Directory, or in a Corporate Directory (if this is set up on your phone).

Searching for Contacts in Your Local Contact Directory

Search for a contact by scrolling through the directory, or entering specific search criteria.

To search for a contact in the local Contact Directory:

1. Tap  > **Features** > **Contact Directory**.

The Directory screen displays.

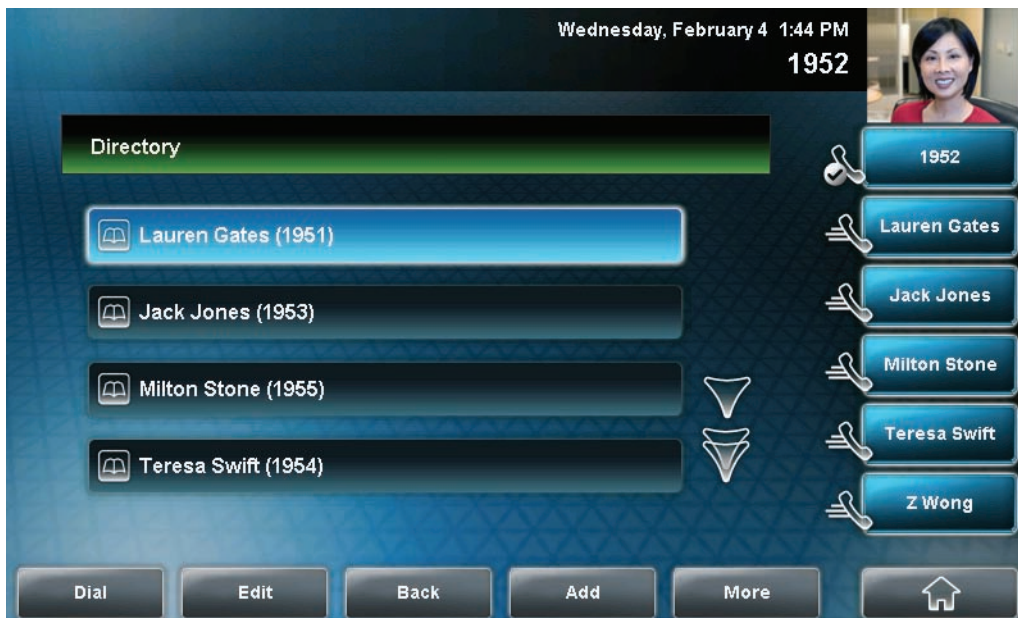

2. Tap the **Search** soft key. Then, enter the first few characters of the contact's first or last name, and then tap the **Search** soft key again.

The screen displays a list of successful matches.

3. Tap  to return to the idle screen.

Searching for Contacts in a Corporate Directory

Search for a contact by scrolling through the directory, or entering specific search criteria.

Note

You can enable your phone to save Corporate Directory search results, and to remember the last person you viewed in the directory. Whenever you re-display Corporate Directory, the last person you viewed will display. If you searched for a person, the results of the last search you submitted will display. To enable this feature, press the **Menu** key, and then tap **Settings > Basic > Preferences > Corporate Directory > View Persistency**. Tap **Enabled**, tap the **Select** soft key, and then tap the **Back** soft key.

To search for a contact in the Corporate Directory:

1. Tap  > **Features > Corporate Directory**.

The Corporate Directory screen displays.

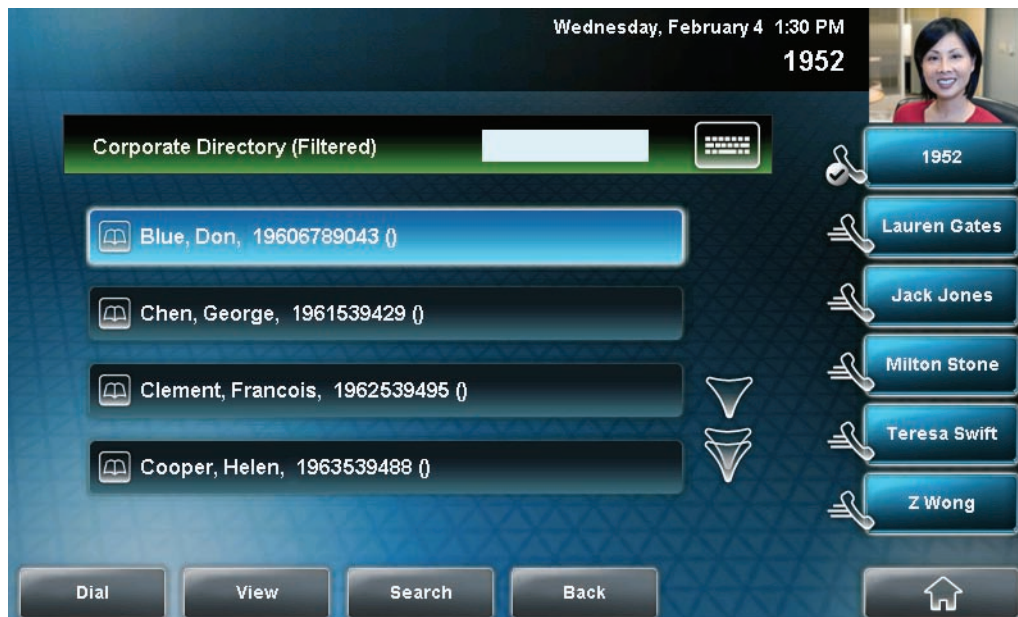

2. Tap the **Search** soft key. Then, enter the first few characters of the contact's first or last name, and then tap the **Submit** soft key.

The screen displays a list of successful matches.

3. Tap  to return to the idle screen.

Updating Contacts in Your Local Contact Directory

You can update contact information for contacts in your local Contact Directory. You cannot update information for contacts in your Corporate Directory.

To update a contact in your local Contact Directory:

1. Tap  > **Features** > **Contact Directory**.

The Directory screen displays.



2. Tap the contact whose information you want to update. Or, search for the contact (see [Searching for Contacts in Your Local Contact Directory](#) on page 2-54).

3. Tap the **Edit** soft key.
The Edit Contact screen displays.



4. Update the contact information.
For information on the fields you can update, see [Adding Contacts Manually](#) (step 3) on page 2-47.
5. Tap the **Save** soft key.
6. Tap  to return to the idle screen.

Deleting Contacts from Your Local Contact Directory

You can delete contacts from your local Contact Directory, but not from your Corporate Directory.

To delete a contact from the local Contact Directory:

1. Tap  > **Features** > **Contact Directory**.

The Directory screen displays.



2. Tap the contact you want to delete. Or, search for the contact (see [Searching for Contacts in Your Local Contact Directory](#) on page 2-54).
3. Tap the **Delete** soft key.
The contact is deleted from the directory.
4. Tap  to return to the idle screen.

Placing Calls to Contacts

You can place calls to contacts from your local Contact Directory or from your Corporate Directory (if this is set up on your phone).

To place a call to a contact in the local Contact Directory:

1. Tap  > **Features** > **Contact Directory**.

The Directory screen displays.

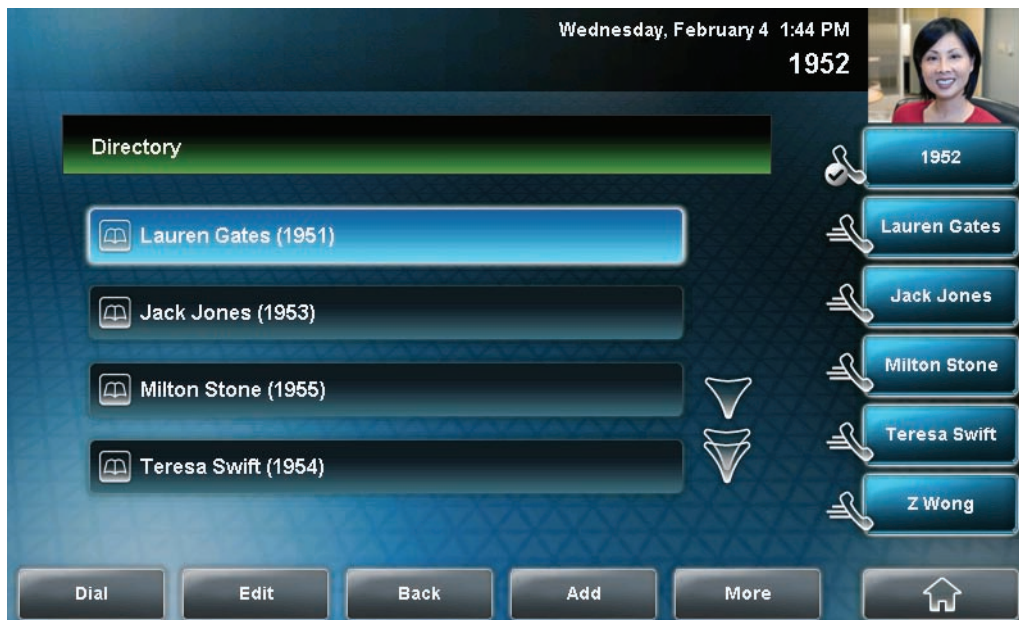

2. Tap the contact you want to call. Or, search for the contact (see [Searching for Contacts in Your Local Contact Directory](#) on page 2-54).
3. Tap the **Dial** soft key.

To place a call to a contact in the Corporate Directory:

1. Tap  > **Features** > **Corporate Directory**.

The Corporate Directory screen displays.

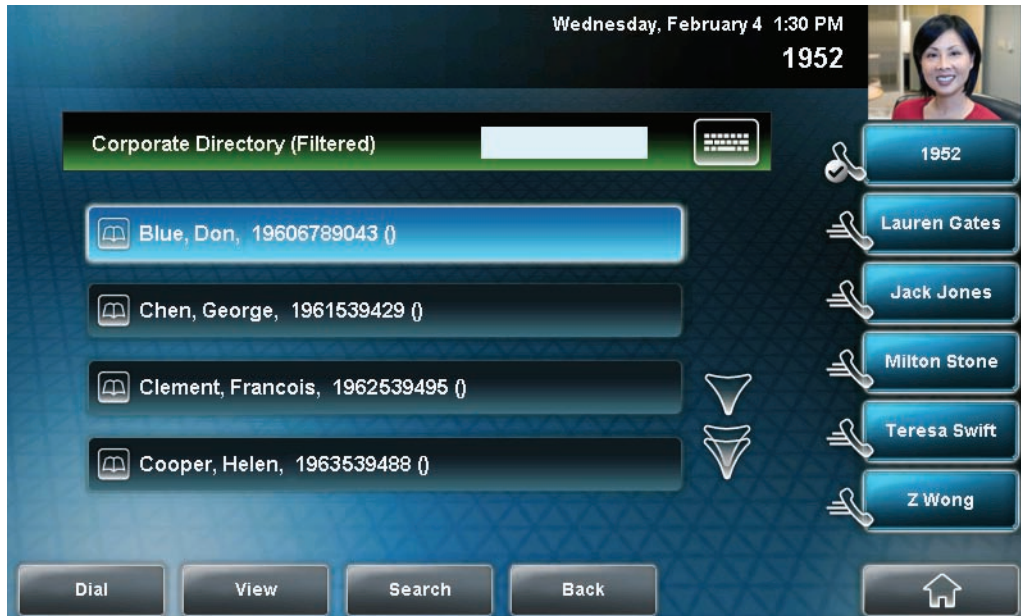

2. Tap the contact you want to call. Or, search for the contact (see [Searching for Contacts in a Corporate Directory](#) on page 2-55).
3. Tap the **Dial** soft key.

Managing Incoming Calls

You can manage incoming calls from the contacts in your directory by doing the following:

- Setting up a distinctive ring tone for a contact.
- Rejecting calls from a particular contact by sending the call to your voice and video mail system. (If you do not have a voice and video mail system set up, the call will still ring on your phone.)
- Diverting calls from a particular contact to another party.

Distinguishing Calls

You can customize your phone so that you can distinguish callers by certain ring tones. For information on setting a distinctive ring tone for a particular contact, see [Setting Ring Tones for Contacts](#) on page 2-21.

Rejecting Calls

You can customize your phone so that incoming calls from a particular party are immediately sent to your voice and video mail system. (If you do not have one set up, the call will still ring on your phone.)

Note

Rejecting calls is not available on shared lines.

To send incoming calls from a particular contact directly to voice/video mail:

1. Tap  > **Features** > **Contact Directory**.

The Directory screen displays.



2. Tap the contact whose information you want to update, and then tap the **Edit** soft key.

The Edit Contact screen displays.



3. Tap the **Auto Reject** field, and then tap the field's highlighted grey box. From the drop-down list, tap **Enabled**.
4. Tap the **Save** soft key.
5. Tap  to return to the idle screen.

Diverting Calls

You can customize your phone so that incoming calls from a particular party are transferred directly to a third party.

To divert incoming calls from a contact to a third party:

1. Tap  > **Features** > **Contact Directory**.

The Directory screen displays.

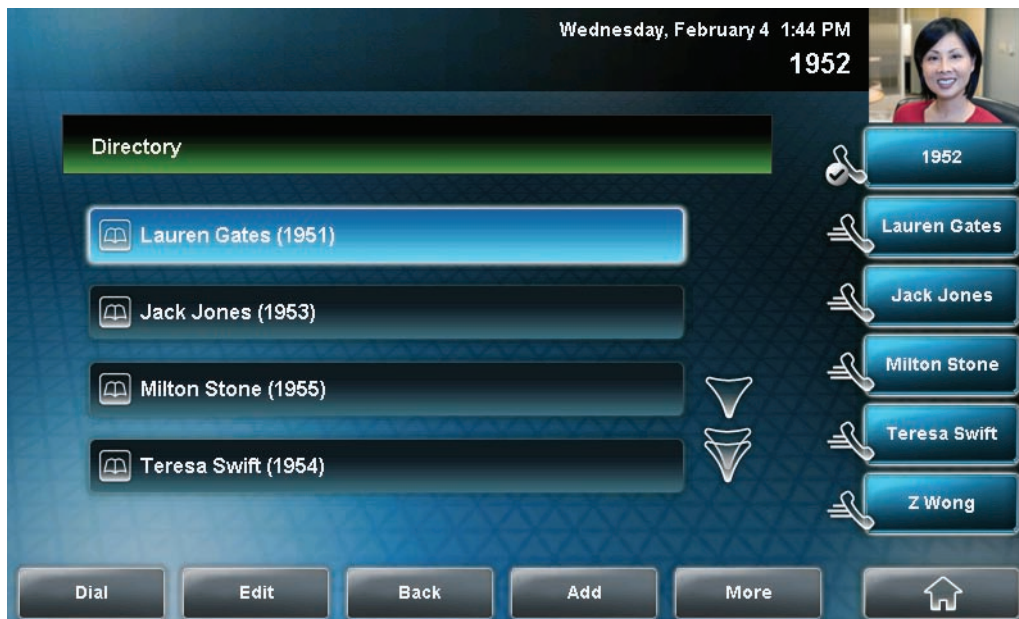

2. Tap the contact for whom you want to transfer calls.
The Edit Contact screen displays.



3. Tap the **Divert Contact** field, and then enter the number of the party to whom you want to divert the call.
4. Tap the **Auto Divert** field, and then tap the field's highlighted grey box. From the drop-down list, tap **Enabled**.
5. Tap the **Save** soft key.
6. Tap  to return to the idle screen.





System Customizations

The following section details how your system administrator can customize your phone. For more information on the following customizations, see your system administrator.

Supporting Multiple Lines

Your phone can support up to six different lines. Lines are assigned to the Line Keys on your phone. Typically, the top-most Line Key is reserved for the principal directory number (DN) of the phone.

When the phone is idle, Line Keys can display the following icons. (For information on icons that display when the phone has a call, see [Phone Icons](#) on page 1-22).

| Line Key Icon | Displays for ... |
|-----------------------------------------------------------------------------------|---------------------------------------------------------------------------------------------------------------------|
|  | Registered, private lines. |
|  | Registered, shared lines. For more information, see Supporting Shared Lines on page 2-68. |
|  | Unregistered lines. |
|  | Lines that have the Always call forwarding type enabled (see Forwarding Calls on page 3-28). |
|  | Lines that have Do Not Disturb enabled (see Enabling Do Not Disturb on page 3-33). |

Your phone can handle a maximum of 24 calls, distributed across all lines. If your phone has two lines, and one line has 24 calls, your phone cannot accept any other calls.

You can set up any available key (that is, one that is not assigned to a line) as

a Speed Dial Key. Speed Dial Keys display  .

The following figure shows a phone set up with one phone line (1952). Since one Line Key is taken, there are five keys available that you can assign as Speed Dial Keys. In this example, five Speed Dial Keys are set up.



The following figure shows a phone set up with six different phone lines (1952, 1953, 1954, 1955, 1956, and 1957). In this case, there are no available keys that you can assign as Speed Dial Keys.

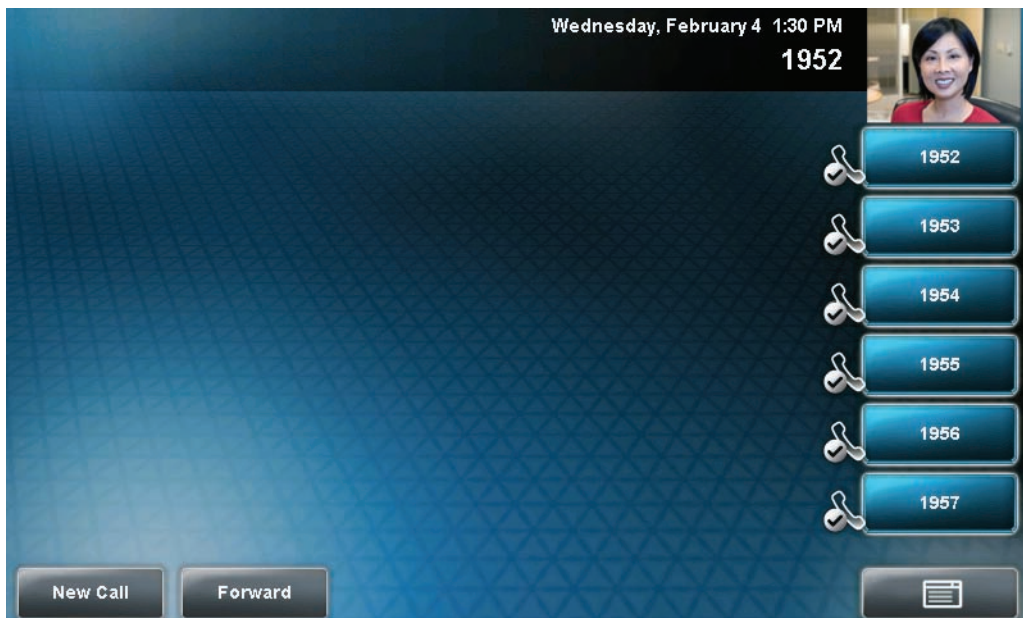

Supporting Multiple Line Keys Per Line

Your system administrator can assign each phone line to a single Line Key, or to multiple Line Keys.

Incoming and outgoing calls for a phone line will be distributed evenly across all Line Keys that are assigned to the phone line. For example, if you have two Line Keys set up for DN 1952, and you have an active call for 1952 on the first Line Key, an incoming call for 1952 will go to the second Line Key.

The following figure shows a phone that is set up with one phone line (DN 1952) that is assigned to three Line Keys. In this case, incoming and outgoing calls for line 1952 will be distributed evenly among the three Line Keys. There are three available keys that are set up as Speed Dial Keys.



Your phone can be set up to have a combination of lines with a single Line Key and lines with multiple Line Keys.

The following figure shows a phone set up with two lines (1952 and 1953) that are each assigned to a Line Key, and a third line (1954) assigned to three Line Keys. There is one available key that is set up as a Speed Dial Key.

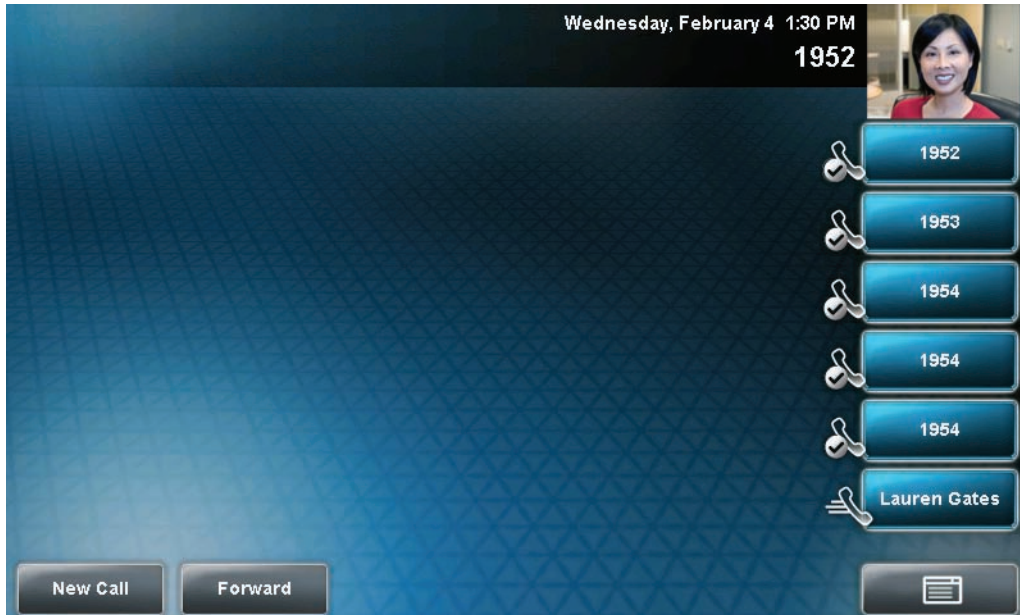

Supporting Shared Lines



Note Shared lines is an optional feature and may not be supported on your particular system. For more information, contact your system administrator.

Note Call Forwarding is not available on shared lines.
Do Not Disturb (DND) on shared lines disables the ringing option only. You will still see a visual notification.

Your system administrator can set up your phone to support shared lines. If two phones share a line, an incoming call to that number will cause both phones to ring. The call can be answered on either phone, but not on both.

Calls on shared lines can be transferred, put on hold, or added to a conference.

The following table shows the Line Key icons and status indicators that display for shared lines.

| Line Key Icon | Shared Line Status | Line Key Status Indicator |
|-----------------------------------------------------------------------------------|-----------------------|---------------------------|
|  | Idle | (No indicator) |
|  | Active call | Solid red |
|  | Call or calls on hold | Flashing red |

In the following figure, line 1952 is shared and line 1953 is private.

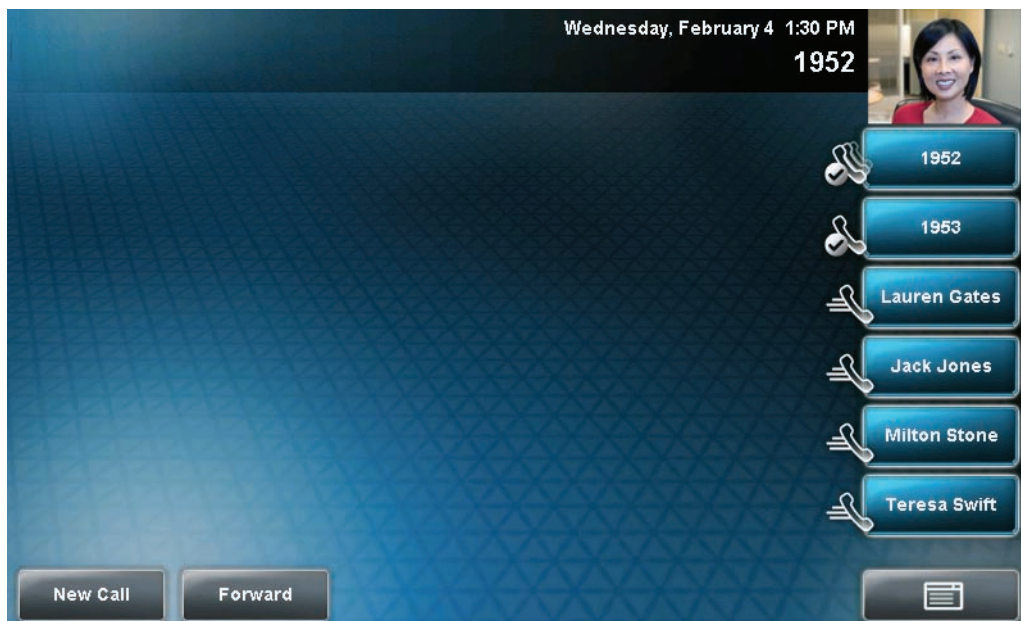

Using the Basic Features of Your Phone

This chapter provides basic operating instructions for the phone. The topics include:

- [Handling Calls](#) on page 3-2
- [Placing Calls](#) on page 3-6
- [Answering Calls](#) on page 3-12
- [Ending Calls](#) on page 3-15
- [Redialing Numbers](#) on page 3-15
- [Placing Calls on Hold](#) on page 3-16
- [Hosting Conference Calls](#) on page 3-18
- [Transferring Calls](#) on page 3-25
- [Forwarding Calls](#) on page 3-28
- [Enabling Do Not Disturb](#) on page 3-33
- [Managing Speed Dial Keys](#) on page 3-38
- [Accessing Voice and Video Mail](#) on page 3-42

To customize your phone, see [Customizing Your Phone](#) on page 2-1. To read about the phone's advanced features, see [Using the Advanced Features of Your Phone](#) on page 4-1.

If you require additional information or assistance with your new phone, contact your system administrator.

Handling Calls

At any time, at most one active call may be in progress on your phone. The active call is the one that has audio or video associated with it. There may be multiple other calls on hold, or in an “Incoming call” or “Ringing” state.

Your phone can handle a maximum of 24 concurrent calls. At most, your phone can handle one active call with 23 calls on hold, or 24 calls on hold.

Your phone displays all active incoming and outgoing calls in a large window in the center of the screen. Inactive calls (calls on hold, or incoming calls that you don’t immediately answer) for a particular Line Key display in a row above the soft keys (the “inactive call group”).

The following figure shows one active and four calls on hold for Line Key 1952.



To select a call on hold, tap the call on hold. New soft keys will display that apply to the selected call. If there are more than three calls on hold, tap



to view and select the additional calls on hold. You can also press the **Right** arrow key or the **Left** arrow key to view and select a call on hold.

The touch screen only displays calls for one Line Key at one time. The calls that currently display on the touch screen are associated with the Line Key that is green.

To display and access the calls on another Line Key, tap that Line Key. When you tap a Line Key, the first call on hold in the inactive call group for that Line Key will automatically resume.

The number of calls associated with a Line Key is indicated by a counter,



, on the Line Key.

A Line Key will either be green or blue:

- Green – Indicates that the Line Key has an active call or an incoming call. A green Line Key is associated with the calls that currently display on the touch screen (active or inactive).
- Blue – Indicates that the Line Key doesn't have an active call, or has an incoming call that has been minimized and placed in the inactive call group. The calls associated with a blue Line Key do not currently display on the touch screen.

Line Keys also have a status indicator (a vertical bar on the far-right of the

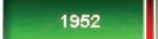
Line Key), . The status indicator can be:



- Solid green – A dial-tone is available, dialing is in progress, or a call is active.
- Flashing green – An incoming call.
- Solid red – A remote shared line is active.
- Flashing red – A call (one or more) is on hold.

Handling Video Calls

Note

Your phone can exchange video with a video endpoint other than a Polycom VVX 1500 phone. For a list of compatible endpoints, see the *Administrator's Guide for the Polycom SoundPoint IP/SoundStation IP Family* available at <http://www.polycom.com/support/voice/>. For more information, see your System Administrator.

Your phone displays video in two windows: a small picture-in-picture (PIP) window located on the top-right of the screen, and a larger window centred in the middle of the touch screen. By default, the near site displays in the PIP, and the far site displays in the window in the center of the touch screen. Information about the call, such as the phone number of the party with whom you are talking and the duration of the call, appears next to the far site when it is displayed in the window in the center of the touch screen.



The following figure shows the near site in the PIP, and the far site, together with call information, in the larger window in the center of the touch screen.



You can tap the PIP to swap the windows the sites display in. When the near site displays in the window in the center of the touch screen, "Local camera" displays next to it.

The following figure shows the near site in the window in the center of the touch screen and the far site in the PIP.



During a video call, you can tap the **Video** soft key or press  to display soft keys that allow you to access video features. The Video soft key is only available when a video call is active. If you press  during an audio-only call, the video soft keys will not display.

During a video call, you can tap the Video soft key to display the following video soft keys:

- **Stop Video/Start Video**—Starts and stops the transmission of near-site video. When you tap the **Stop Video** soft key, the far-site will no longer see you.

When you tap the **Stop Video** soft key, the stop video icon, , displays next to the near site, in either the PIP or in the larger window in the center of the touch screen.

Note

If you want, you can disable video across all calls, not just for the current call. For information on disabling video for all calls, see [Disabling and Stopping Video](#) on page 2-23.

You cannot start and stop far-site video. When your phone receives far-site video, your phone will always display the far site.

- **Full Screen**—Displays the video that is in the center of the screen on the full screen. The PIP still displays in the corner, but the soft keys are hidden. (Depending on the video endpoint, you may or may not see the black bars.)



To display the site in the center of the touch screen and to access soft keys again, tap the touch screen outside of the PIP. (If you tap the PIP, you will just swap the windows the sites display in.)

Note

You don't have to access the video soft keys to display video on the full screen. During a video call, tap the window in the center of the touch screen to display the site on the full screen. To display the site in the center of the touch screen again, tap the touch screen outside of the PIP. (If you tap the PIP, you will just swap the windows the sites display in.)

- **Swap**—Switches the windows the sites display in. For example, the site in the PIP will display in the window in the center of the touch screen, and the site in the window in the center of the touch screen will display in the PIP.

Note

You don't have to access the video soft keys to swap the windows the sites display in. During a video call, tap the PIP to swap the windows the sites display in. To swap windows again, tap the PIP again.

If you want, you can set up your phone to automatically display the far site on the full screen. For more information, see [Updating Video Settings](#) on page 2-24.

- **Back**—Displays the call soft keys again (Hold, End Call, Transfer, and Conference).

For more information on using video and updating video settings, see [Updating Video Settings](#) on page 2-24.



Placing Calls

You can place a call in various ways using your phone:

- Using the handset
- Using the speakerphone
- Using the headset

You can dial the number first, and then choose the method to speak to the other party (handset, speakerphone, or headset), or choose the method first, and then dial the number. You can also place a call using a URL or IP address.

During a call, you can alternate between handset, headset, or speakerphone

modes by picking up the handset, or pressing  or . For

example, if you are using the handset, you can switch to headset mode by

pressing , or switch to speakerphone mode by pressing .

Your phone monitors the duration of all calls through a local call timer. You can view the call timer for the active call and for calls on hold.

In the figure below, the active call to Jack Jones has lasted for 21 minutes, 19 seconds. The calls to James and Jacklyn have lasted for 41 minutes, 21 seconds and 41 minutes, 39 seconds respectively.

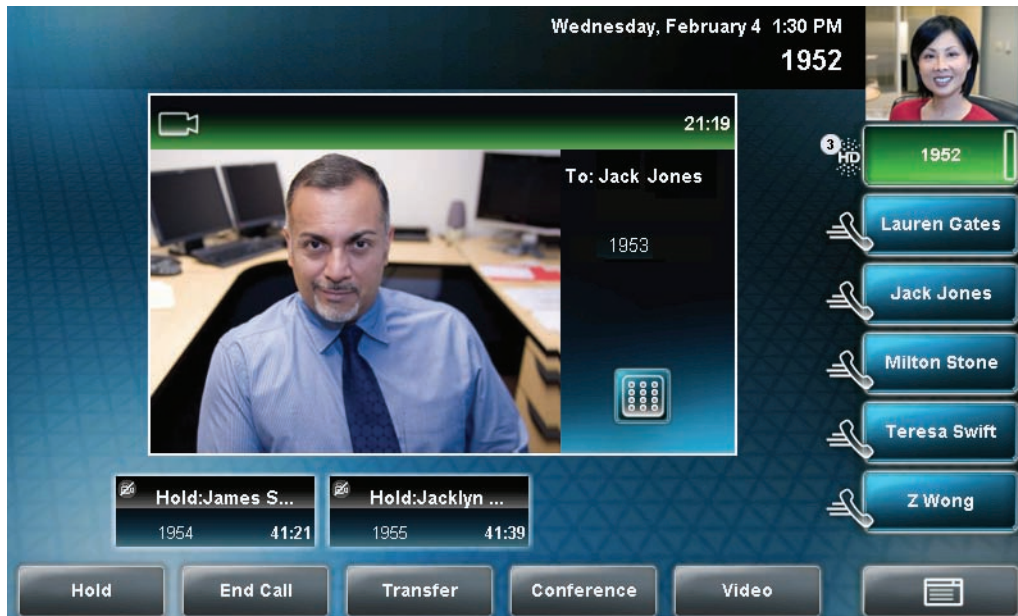

Note

Instead of entering a phone number from memory, you can access call lists, directories, and speed dial lists to display and dial numbers for you. You can also redial numbers. For more information, see [Using Call Lists](#) on page 2-41, [Managing Contacts](#) on page 2-44, [Placing Calls Using Speed Dial](#) on page 3-10, and [Redialing Numbers](#) on page 3-15.

Place Calls Using the Handset

Dialing Numbers Using the Handset

To dial a number using the handset:

>> Do one of the following:

- Pick up the handset, and then enter the phone number.

Note

Your system administrator sets up your phone to automatically place the call after you enter a certain number of digits. If your phone does not automatically place the call after you enter a phone number, tap the **Send** soft key.

or

- Enter the phone number, tap the **Dial** soft key, and then pick up the handset.

Dialing URLs or IP Addresses Using the Handset

To dial a URL or IP address using the handset:

1. Pick up the handset.
2. Tap the **URL** soft key.
3. Enter the URL or IP address. (See [Entering Data and Editing Fields](#) on page 1-27).
4. Tap the **Send** soft key.

Placing Calls Using the Speakerphone

Note

If your speakerphone does not work, your system administrator may have disabled the speakerphone on your phone. You must handle calls using the handset or a headset.

If your system administrator disables the speakerphone on your phone, “Handsfree mode disabled” appears on the touch screen after you press the **SP PHONE** key.

Dialing Numbers Using the Speakerphone

To dial a number using the speakerphone:

>> With the handset on-hook, do one of the following:

- Tap the **New Call** soft key or the Line Key, or press  to obtain a dial tone. Then, enter the phone number.

Note

Your system administrator sets up your phone to automatically place the call after you enter a certain number of digits. If your phone does not automatically place the call after you enter a phone number, tap the **Send** soft key.

or

- Enter the phone number, and then tap the **Dial** soft key or the Line Key, or press .

Dialing URLs or IP Addresses Using the Speakerphone

To dial a URL or IP address using the speakerphone:

1. Tap the **New Call** soft key or the Line Key, or press .
2. Tap the **URL** soft key.
3. Enter the URL or IP address. (See [Entering Data and Editing Fields](#) on page 1-27).
4. Tap the **Send** soft key.

Placing Calls Using the Headset

Note

To permanently enable your headset, see [Enabling Headset Memory Mode](#) on page 2-7.

Dialing Numbers Using the Headset

To dial a number using the headset:

>> With the optional headset connected, do one of the following:

- Tap the **New Call** soft key or the Line Key to obtain a dial tone. Then, press , and then enter the phone number.

Note

Your system administrator sets up your phone to automatically place the call after you enter a certain number of digits. If your phone does not automatically place the call after you enter a phone number, tap the **Send** soft key.

or

- Enter the phone number, tap the **Dial** soft key, and then press



Dialing URLs or IP Addresses Using the Headset

To dial a URL or IP address using the headset:

1. Tap the **New Call** soft key or the Line Key to obtain a dial tone.
2. Press .
3. Tap the **URL** soft key.
4. Enter the URL or IP address. (See [Entering Data and Editing Fields](#) on page 1-27).
5. Tap the **Send** soft key.

Placing Calls Using Speed Dial

Note

A contact may not have a speed dial number. To find out what a contact's speed dial index number is, or to assign or update a speed dial index number, see [Updating Contacts in Your Local Contact Directory](#) on page 2-56.

You can quickly “speed dial” a contact by doing one of the following:

- Tapping the contact's Speed Dial Key.

Not all contacts have a Speed Dial Key. For information on Speed Dial Keys, see [Managing Speed Dial Keys](#) on page 3-38.

- Accessing the Speed Dial Information screen.

To place a call to a contact using speed dial:

>> Do one of the following:

- Tap the contact's Speed Dial Key.

The following figure shows the location of Speed Dial Keys on the touch screen. Speed Dial Keys display .

In the following figure, Speed Dial Keys are assigned to Lauren Gates, Jack Jones, Milton Stone, Teresa Swift, and Z Wong.

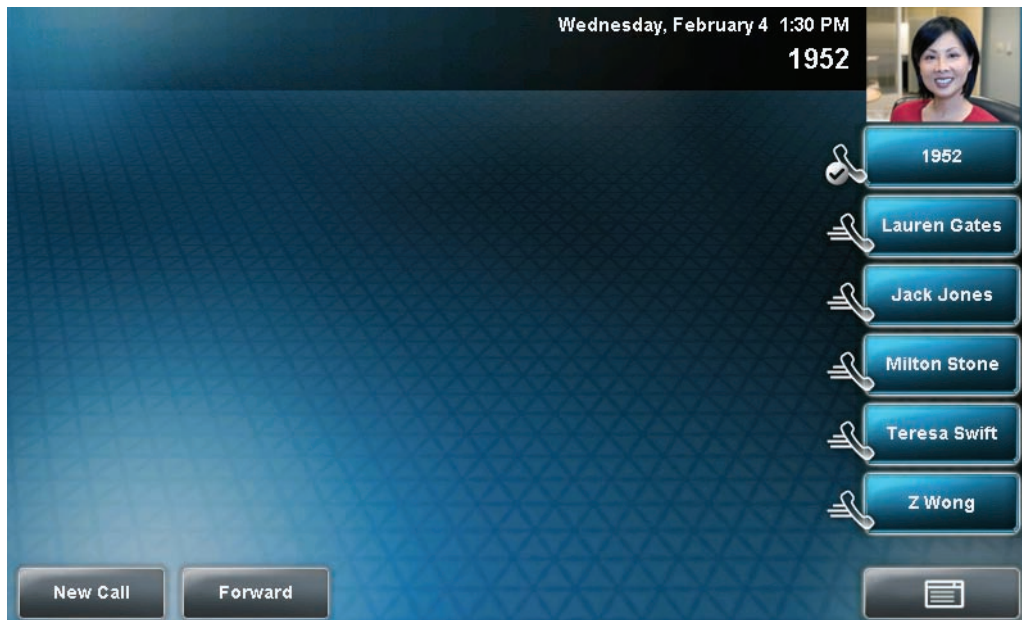

or

- From the idle screen, press the **Up** arrow key. From the Speed Dial Information screen, tap the contact.

or

- If the contact has a speed dial index number that is equal to or less than 99, enter the speed dial index number from the idle screen, and then

press  (on the phone console). From the Speed Dial Information screen, tap the **Dial** soft key.

The call is placed.

Answering Calls

When you are not in another call, you can answer a call in three ways:

- Using the handset
- Using the speakerphone
- Using the headset

Note

Your phone distributes incoming calls for lines that have multiple Line Keys evenly across all Line Keys.

Note

If you don't want to answer a call, or you want to delay answering a call, do the following:

- To remove the incoming call window in the center of the touch screen, minimize it, and place it in the inactive call group (so you can still answer it, if you want), tap the **Ignore** soft key.
- To remove the incoming call window and the opportunity to answer the call, tap the **Reject** soft key (for private lines), the **Silence** soft key (for shared lines) or press the **DND** key (Do Not Disturb) when your phone rings. The Do Not Disturb mode stays active until you press the **DND** key again.
- To forward incoming calls to another phone, tap the **Forward** soft key (see [Forwarding Calls Dynamically](#) on page 3-33). (If your phone is set up with shared lines, there is no **Forward** soft key.)

Note

If you set up your phone with a silent ring, tap the Line Key with the status indicator that is flashing green, or tap the **Answer** soft key, to answer the call. If your handset is off-hook, the call is routed to the handset. If your handset is on-hook, the call is routed to the speaker.

Answering When Not in Another Call

In all cases, the active call will appear on the screen and display the call duration and who the call is from.

The following figure shows an active video call.



To answer a call using the handset:

>> Pick up the handset.

To answer a call using the speakerphone:

Note

If your speakerphone does not work, your system administrator may have disabled the speakerphone on your phone. Handle calls using a handset or headset instead. If your system administrator disables the speakerphone on your phone, "Handsfree mode disabled" appears on the touch screen after you press the **SP PHONE** key.

>> With the handset on-hook, do one of the following:

- Tap the incoming call window that displays in the middle of the touch screen.
(After 10 seconds, the incoming call is placed in the inactive call group, and you have to tap the **Answer** soft key to answer it.)
- Tap the **Answer** soft key.
- Tap the Line Key with the status indicator that is flashing green.
- Press  .

To answer a call using the headset:

>> Do one of the following:

- Press  .

or

- If Headset Memory Mode is activated, tap the Line Key with the status indicator that is flashing green, or tap the **Answer** soft key.

Answering When in Another Call

If you have an active call and an incoming call arrives (on the same or a different Line Key), the following happens:

- A call waiting tone beeps.
- The status indicator on the Line Key indicator associated with the incoming call flashes green.
- The call counter for the Line Key associated with the incoming call increments by one (showing the number of calls associated with the Line Key, including the incoming call).
- Caller information for the incoming call displays in a window in the center of the touch screen, and the Line Key associated with the incoming call glows green. After a certain length of time, the window is minimized and placed in the inactive call group, and the Line Key associated with the call glows blue (if there is an active call on another Line Key).

To answer an incoming call when you are in another call:

>> Tap the Line Key with the status indicator that is flashing green, or tap the **Answer** soft key. The original call is automatically placed on hold, and the incoming call becomes the active call.

Note

If you wait too long, the incoming call window is minimized and placed in the inactive call group (along the bottom of the touch screen), and the active call reappears in the window in the center of the touch screen. To answer the incoming call, tap the Line Key with the status indicator that is flashing green, or tap the **Hold** soft key to place the active call on hold, and then tap the **Answer** soft key.

To answer an incoming call on a shared line:

1. Tap the Line Key with the status indicator that is flashing green, or tap the **Answer** soft key.
2. Tap the **Hold** soft key or press  .

Note



If you wait too long, the incoming call window is minimized and placed in the inactive call group (along the bottom of the touch screen), and the active call reappears in the window in the center of the touch screen. To answer the incoming call, tap the Line Key with the status indicator that is flashing green, or tap the **Hold** soft key to place the active call on hold, and then tap the **Answer** soft key.

Anyone on another phone configured to use the same shared line may take the call by tapping the Line Key associated with the held call (represented by a flashing red status indicator).

Ending Calls

To end a call:

>> Do one of the following:

- Tap the **End Call** soft key.
- If you are in handset mode, replace the handset.
- If you are in speakerphone mode, press  .
- If you are in headset mode, press  .

Redialing Numbers

Redial a number by pressing  , or accessing your placed calls list.

To redial the last call placed from your phone:

>> Press  .

A call to your last placed call is attempted.

To redial a previously placed call:

1. Do one of the following:

- Tap  > **Features** > **Call Lists** > **Placed Calls**.

or

- From the idle screen, press the **Right** arrow key.

The Placed Calls list displays.





2. Tap the call you want to dial, and then tap the **Dial** soft key.

Note

You can also place a call from the Missed Calls and Received Calls lists. To access the Missed Calls list, press the **Down** arrow key. To access the Received Calls list, press the **Left** arrow key.

Placing Calls on Hold

To place a call on hold, tap the **Hold** soft key or press  during an active call. When you place a call on hold, the following happens:

- The hold icon, , will display on the Line Key.
- The Line Key status indicator will flash red.
- The call's window is minimized and placed in the inactive call group (above the soft keys). The inactive call window displays "Hold."

The following figure shows a call with Joan Smith on hold. The hold icon, and the flashing red status indicator, display on the Line Key.

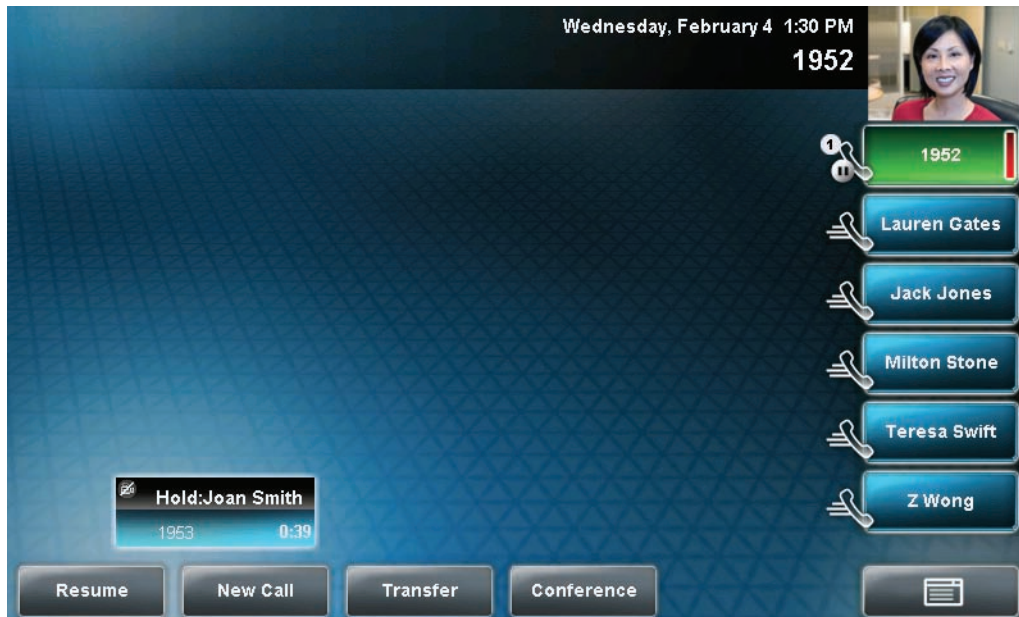

Tap the **Resume** soft key, or press  again, to retrieve the call.

If you have more than one call on hold, tap the call you want to resume, and then tap the **Resume** soft key. If you tap the Line Key, the first call in the inactive call group for the Line Key will automatically resume.

Note

The Hold feature typically generates music or a beeping tone. Therefore, avoid placing a conference call on hold.

Multiple Calls on Hold

Your phone displays all calls for a Line Key by displaying multiple windows on the screen. The phone only displays the calls for one Line Key at a time.



The active call (if any) displays in a window in the center of the touch screen. Held calls or incoming calls display in minimized windows above the phone's soft keys (the "inactive call group"). The Line Key associated with the displayed calls is green. The Line Key displays a counter showing the number of calls for the Line Key. If all the calls for a Line Key are inactive, the status indicator for the Line Key glows red. If the Line Key has an active call, the status indicator glows green.

The following figure shows one active call and four calls on hold for Line Key 1952.



To select a call on hold, tap the call on hold. New soft keys will display that apply to the selected call. To resume the call, tap the **Resume** soft key or press



If there are more than three calls on hold, tap  or  to display additional calls on hold. You can also press the **Right** arrow key or the **Left** arrow key to select a call on hold.

To access the calls on another Line Key, tap that Line Key. When you tap a Line Key, the first call on hold in the inactive call group for that Line Key will automatically resume.

Hosting Conference Calls

You can create a conference with two other parties using the phone's local conference feature. During a conference call, your phone can exchange video with only one conference participant (even if more than one participant can send video). The participant with whom you exchange video depends on how you set up the conference. You also have the option of choosing the participant with whom to exchange video (see [Managing Conference Call Participants](#) on page 3-22).

During a conference, you have access to the conference management feature. This feature allows you to manage each participant in the conference call. You can mute, hold, and remove individual participants, as well as choose the conference participant with whom to exchange video. For more information, see [Managing Conference Call Participants](#) on page 3-22.

This section provides the following instructions:

- [Setting Up Conference Calls](#) on page 3-19
- [Holding and Resuming Conference Calls](#) on page 3-21
- [Ending Conference Calls](#) on page 3-22
- [Splitting Conference Calls into Two Calls on Hold](#) on page 3-22
- [Managing Conference Call Participants](#) on page 3-22
- [Handling Video During Conference Calls](#) on page 3-25

Setting Up Conference Calls

Note

Your system administrator configures the maximum number of parties allowed in a conference call. The default value is three (including yourself). For more information, contact your system administrator.

You can set up a conference in one of two ways:



- Using the Conference soft key or . The participant with whom you will exchange video is the participant you most recently added to the conference (if the party can exchange video).
- Using the **Join** soft key, if you have an active call and one call on hold (on the same or another Line Key). The participant with whom you will exchange video is the party who was previously on hold (if the party can exchange video).

Note

If the site for which you view video changes to a different site after you set up a conference, the message “Video can only be active with one party at a time” displays.

To choose the participant with whom to exchange video, see [Managing Conference Call Participants](#) on page 3-22.

To set up a conference call using the Conference soft key or key:

1. Call the first party. See [Placing Calls](#) on page 3-6.
2. Tap the **Conference** soft key or press  to create a new call. The active call is placed on hold.
The Conference with: screen displays.
3. Call the second party. See [Placing Calls](#) on page 3-6.
4. When the second party answers, tap the **Conference** soft key or press  again to join all parties in the conference.

Note

If configured for single key-press conferences, you do not need to tap the Conference soft key again.

If the second participant can exchange video, you will exchange video with the second participant. If the second participant cannot exchange video, but the first participant can, you will exchange video with the first participant.

The Conference window displays.



To set up a conference call with an active call and a call on hold:

Note

You can only set up a conference with an active call and a call on hold if you only have one call on hold. If you have more than one call on hold, you have to set up a conference using the Conference key or soft key.

>> If you have an active call and a call on hold (either on the same Line Key or a different Line Key), tap the **Join** soft key.

The Conference screen displays.



A conference is created with the active call, the call on hold, and yourself. The conference call takes place on the Line Key from which you handled the last active call.

If the participant who was previously on hold can exchange video, you will exchange video with that participant. If the participant who was on hold cannot exchange video, you will exchange video with the other participant.

Holding and Resuming Conference Calls

When you place a conference call on hold, you place all other conference participants on hold.

To place a specific participant on hold, see [Managing Conference Call Participants](#) on page 3-22.

To place a conference call on hold:

>> During a conference call, tap the **Hold** soft key.

The other parties in the conference call are placed on hold. The Conference window is minimized and placed in the inactive call group.

To resume the conference call, tap the **Resume** soft key. To end the conference call and place all other conference call participants on hold, tap the **Split** soft key.

Ending Conference Calls

You can end a conference, and your connection to the other parties, by tapping the End Call soft key. When you tap the End Call soft key, the other participants remain connected.

To end a conference call:

>> During a conference call, tap the **End Call** soft key.

The other parties remain connected.

Splitting Conference Calls into Two Calls on Hold

When a conference is established, a Split soft key is available. When you split a conference, you end the conference and place all parties on hold. The Split soft key is available during conference calls, and when a conference call is on hold.

To split a conference call:

>> During a conference call, tap the **Split** soft key. (If a conference call is on hold, tap the conference call window, and then tap the **Split** soft key.)

The conference ends, and all calls are split into individual calls and put on hold.

Managing Conference Call Participants

When you manage conference call participants, you can do the following:

- Mute a participant.
- Place a participant on hold.
- Remove a participant from the conference.
- Obtain information about a participant.
- Choose the participant with whom to exchange video.

To manage a participant, tap the window of the participant you want to manage. The soft keys update to show Far Mute, Hold, Remove, Information, and Back.

The following figure shows the soft keys that display when you manage a conference call participant. If the participant you tapped is not the participant with whom you are exchanging video, the Select Video soft key also displays.

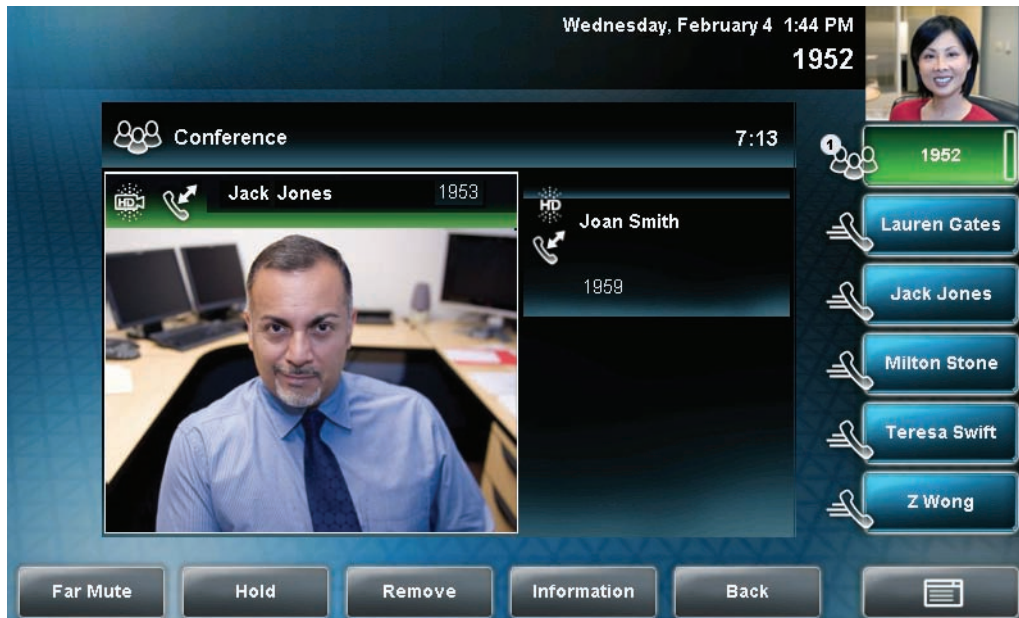

To manage a conference call:

1. During a conference call, tap the window of the conference call participant you want to manage.

The soft keys update so you can manage the participant.

You can access the following soft keys:

- **Far Mute** – Mutes the selected participant. The muted participant can hear all participants, but no participant can hear the muted participant.
- **Select Video** – Selects the conference call participant as the “active” conference participant. This is the participant with whom you will exchange video.



(The Select Video soft key does not display if you are currently exchanging video with the selected participant, or if the participant is not calling from a video endpoint.)

- **Hold** – Places a selected participant on hold. The held participant cannot hear any parties and no participant can hear the held participant.
- **Remove** – Removes the selected participant from the conference, ends the conference call, and creates an active call between you and the other participant.
- **Info** – Provides additional information about the selected participant.
- **Back** – Displays the conference call soft keys again (Hold, End Call, Manage, Split, Video).

2. Do one of the following:

- To mute a participant, tap the participant, and then tap the **Far Mute** soft key.

The muted participant can hear all participants, but no participant can hear the muted participant. The far mute icon, , displays in the participant's window.

(If you press  instead of tapping the **Far Mute** soft key, all other participants can hear each other, but they cannot hear you. The mute icon, , displays next to near-site video.)

To un-mute the party, tap the **UnMute** soft key.

- To select a party as the “active” conference participant (the participant with whom you will exchange video), tap the participant, and then tap the **Select Video** soft key.
- To place a participant on hold, tap the participant, and then tap the **Hold** soft key.

The held participant cannot hear any participants and no participant can hear the held participant.

To return the participant to the conference, tap the **Resume** soft key.

(If the held participant taps the Hold soft key or presses  on their phone, the participant will still be held within the conference even if you tap the **Resume** soft key.)

To place a conference call on hold, see [Holding and Resuming Conference Calls](#) on page 3-21.

- To remove a participant from the conference, tap the **Remove** soft key.

Handling Video During Conference Calls

During a conference call that includes a video endpoint, you can tap the **Video** soft key (if you aren't managing a conference participant) or press



to display soft keys that allow you to start and stop near-site video, display video on the full screen, or swap the windows that near-site and far-site video display in. For more information, see [Handling Video Calls](#) on page 3-3.

Transferring Calls

A call can be transferred in one of three ways:

- Consultative transfer – The party to whom you want to transfer the call answers their phone before you transfer the call or hang up. You can consult with them before completing the transfer. You also have the option of transferring the call before the party answers.
 - [Performing a Consultative Transfer](#) on page 3-25.
- Blind transfer – The call is automatically transferred after you dial the number of the party to whom you want to transfer the call. You do not have the option of talking to the party.
 - [Performing a Blind Transfer](#) on page 3-27.
- Attended transfer – Conference call parties are automatically connected to each other after you exit a conference.
 - Set up a conference call and then end your participation. For more information, see [Ending Conference Calls](#) on page 3-22.

Performing a Consultative Transfer



Perform a consultative transfer if you want to talk to the party to whom you are transferring the call. Or, you can choose not to talk to the party. In this case, you wait for the party's ring-back sound, and then transfer the call.

To transfer a call:

1. During a call, tap the **Transfer** soft key or press . The active call is placed on hold.

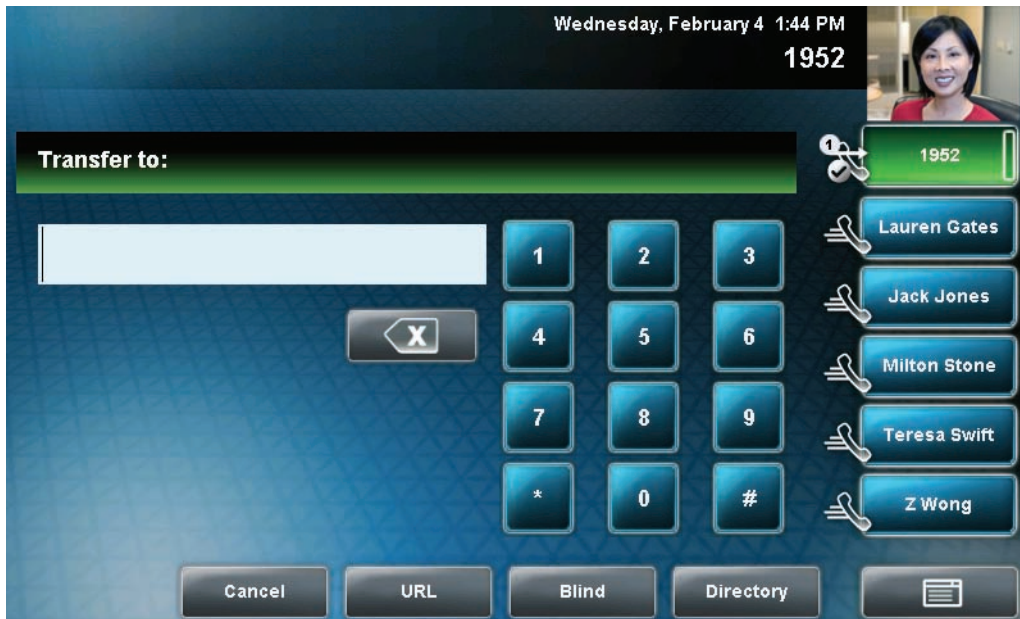
The Transfer to: screen displays.



2. Place a call to the party to whom you want to transfer the call. See [Placing Calls](#) on page 3-6.
3. When you hear the ring-back sound, tap the **Transfer** soft key or press . If you want to talk privately to the person to whom you are transferring the call before the transfer is complete, wait until the person answers the call, talk to the person, and then tap the **Transfer** soft key or press .

If you are using a handset, the transfer can be completed by putting the handset on the cradle.

You can cancel the transfer before the call connects by tapping the **Cancel** soft key.

Performing a Blind Transfer

When you use a blind transfer, you transfer a call without speaking to the party to whom you are transferring the call. The call is automatically transferred as soon as you dial the party's number.

To perform a blind transfer:

1. During a call, tap the **Transfer** soft key or press  .

The Transfer to: screen displays, with the Blind soft key.

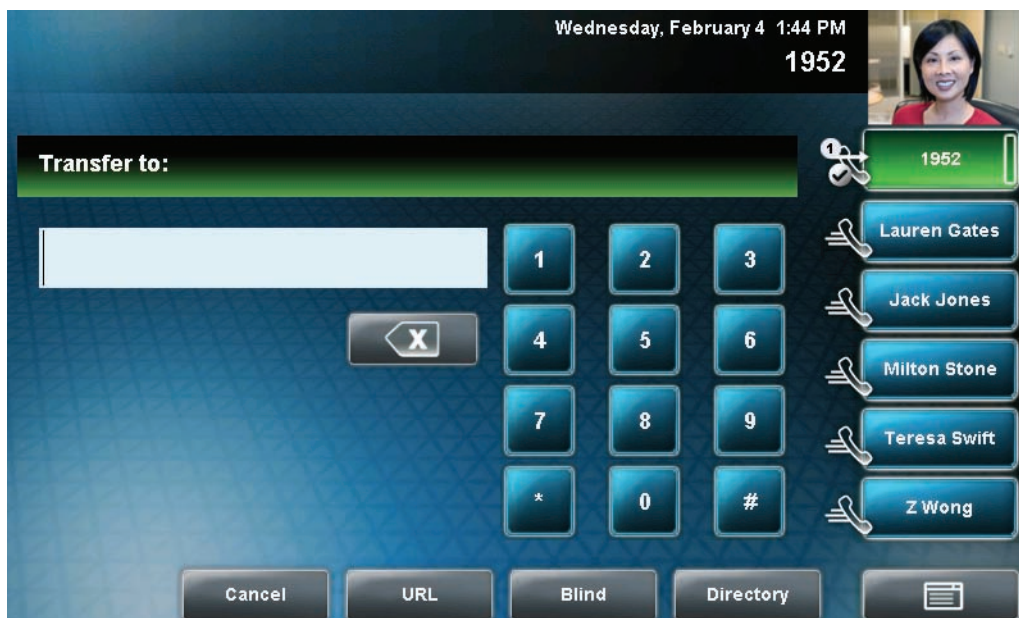

2. Tap the **Blind** soft key.

The Blind transfer to: screen displays.

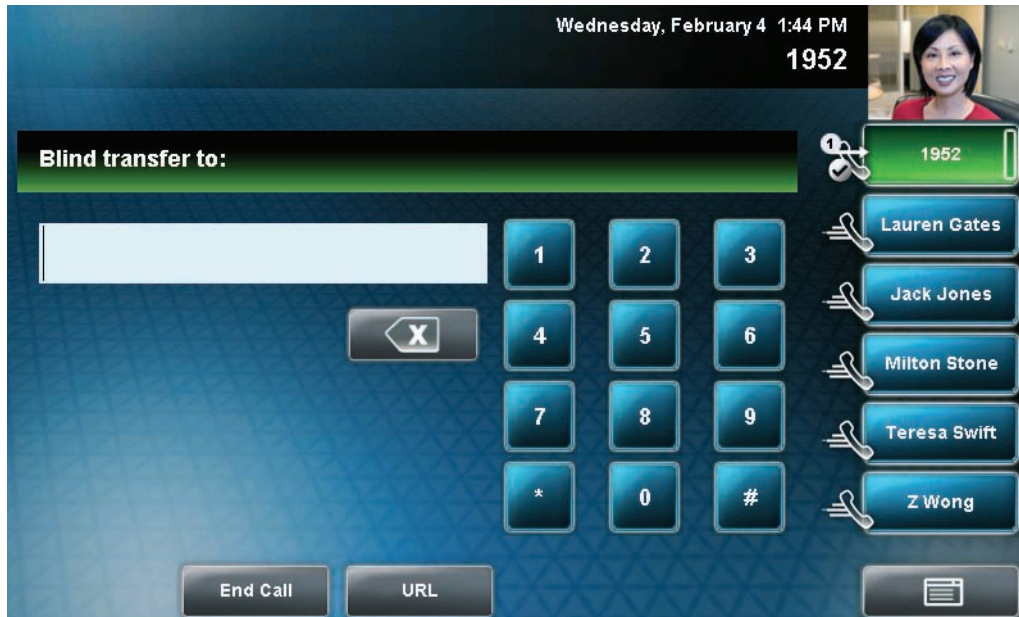

3. Place a call to the party to whom you want to transfer the call. See [Placing Calls](#) on page 3-6.

The call automatically transfers to the party you specified.

Forwarding Calls

Note

Your company's settings may override this feature. For more information, contact your system administrator.
Call forwarding is not available on shared lines.

You can set up your phone to forward incoming calls to another party (static forwarding) or you can forward a call as your phone rings (dynamic forwarding). Your phone will forward calls even if you enable the Do Not Disturb feature.

You can also reject calls from a particular contact (by sending the call to your voice and video mail system), or divert calls from a particular contact to another party. For more information, see [Managing Incoming Calls](#) on page 2-60.

Forwarding Calls Staticly

You can set up your phone to forward all calls to another number.

To forward all incoming calls to another party:

1. Do one of the following:

– Tap  > **Features** > **Forward**.

or

– From the idle screen, tap the **Forward** soft key.

If your phone is set up with a single line, the Forwarding Type Select screen displays.



If your phone is set up with multiple lines, the Line Select screen displays.

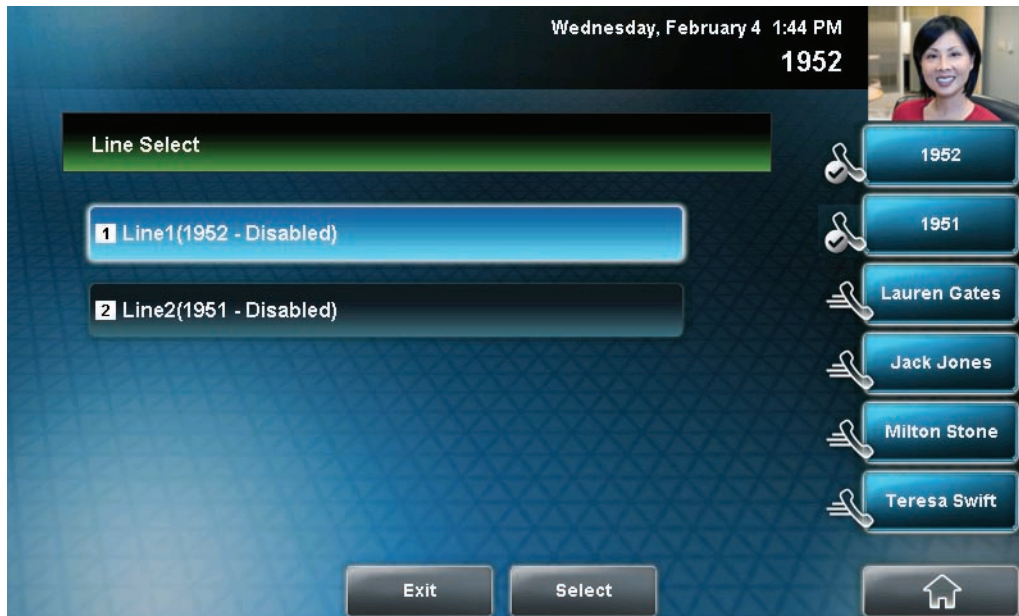

Tap the line for which you want to forward calls. The Forwarding Type Select screen displays.

2. Tap the forwarding type you want. The options are:
 - **Always** – To forward all incoming calls.
 - **No Answer** – To forward all unanswered incoming calls.
 - **Busy** – To forward calls that arrive when you are already in a call.
3. Do one of the following:
 - If you selected **Always**, enter a number to forward all future incoming calls to.
 - If you selected **No Answer**, do the following:
 - In the **Contact** field, enter a number to forward all unanswered incoming calls to.
 - Tap the **Forward After Rings** field, and then enter how many rings to wait before forwarding the call (one ring is approximately six seconds). A value of 2 is recommended.
 - If you selected **Busy**, enter a number to forward all future incoming calls to when you are already in another call.

Note

You can also enter the URL or IP address. For more information on using a URL or IP address, see [Placing Calls](#) on page 3-6.

4. Tap the **Enable** soft key to confirm call forwarding.

If you chose to always forward calls, the Line Key displays the forwarding icon, , to indicate that the **Always** forwarding type is enabled. If you enabled the Busy or No Answer forwarding type, the Line Key icon does not change.

The following figure shows Line 1952 with the **Always** forwarding type enabled.



To disable call forwarding:

1. Do one of the following:
 - Tap  > **Features** > **Forward**.
 - or
 - From the idle screen, tap the **Forward** soft key.

If your phone is set up with a single line, The Forwarding Type Select screen displays.



If your phone is set up with multiple lines, the Line Select screen displays.

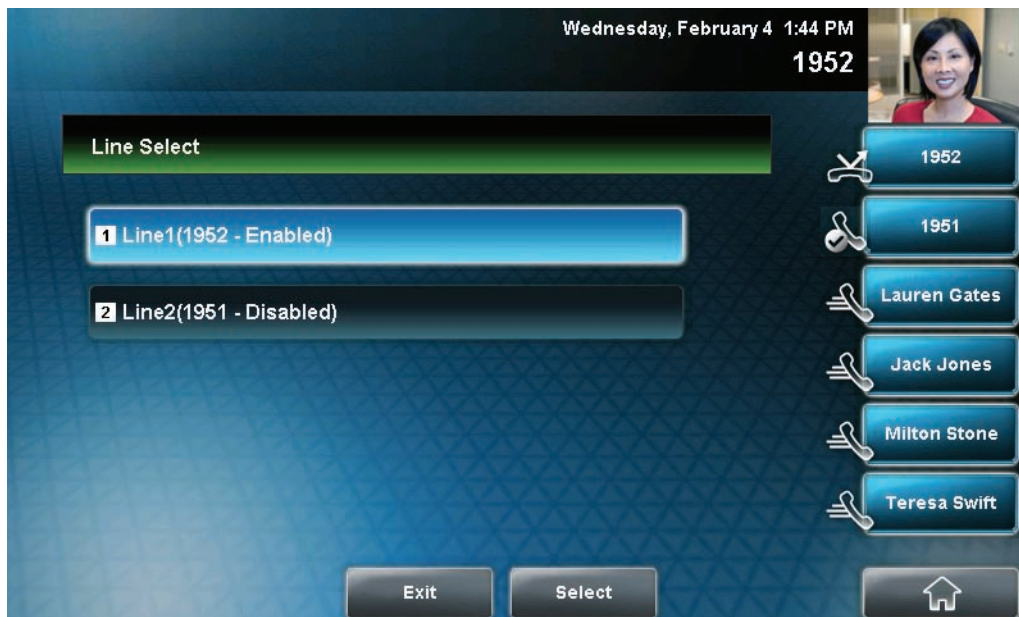

Tap the line for which you want to disable call forwarding. The Forwarding Type Select screen displays.

2. Tap the forwarding type you want to change, and then tap the **Disable** soft key.

Forwarding Calls Dynamically

You can manually forward a call to another number while your phone rings.

To forward an incoming call to another party:

1. While your phone rings, tap the **Forward** soft key.
2. Enter the phone number to forward the incoming call to.

Your phone displays the last number you forwarded calls to (either statically or dynamically).

3. Tap the **Forward** soft key.

The incoming call is forwarded to the other party. If call forwarding is disabled, all future calls will not be forwarded and forwarding will remain disabled.

Enabling Do Not Disturb

Note

Do Not Disturb is an optional feature that your system administrator sets up. Your system may not support it. For more information, contact your system administrator.

To prevent the phone from ringing, press . When you enable Do Not



Disturb, the Do Not Disturb icon, , displays on the status bar and on

each Line Key, and the Do Not Disturb button, , glows red.

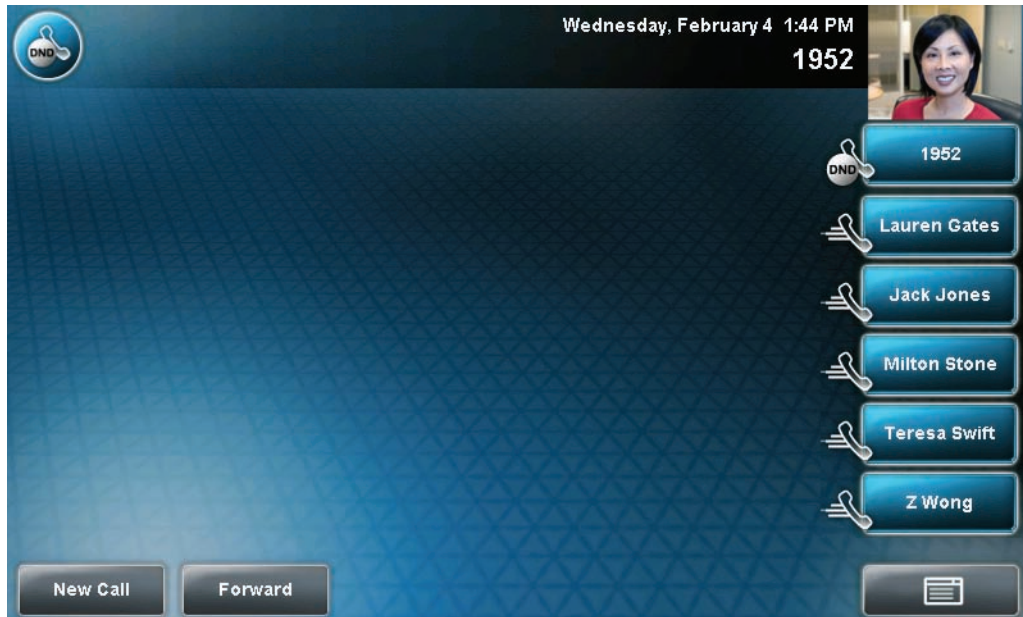
The following figure shows the Do Not Disturb icon on the status bar and on the Line Key.



Calls you receive while Do Not Disturb is enabled are logged in your Missed Calls list (see [Using Call Lists](#) on page 2-41). If you have chosen to forward your calls to another number, calls will be sent to that number if you enable the Do Not Disturb feature.

To disable Do Not Disturb, tap  or press .

Multiple Lines and Do Not Disturb

Note

By default, the Do Not Disturb feature applies to all lines on your phone (that is, you cannot apply the feature to a particular line). For more information, contact your system administrator.

Your system administrator can enable your phone so that you can enable Do Not Disturb on a line-by-line basis. The Do Not Disturb icon, , will display on each Line Key for which Do Not Disturb is enabled.

To enable Do Not Disturb for a particular line:

1. Press  .

The Line Select screen displays.

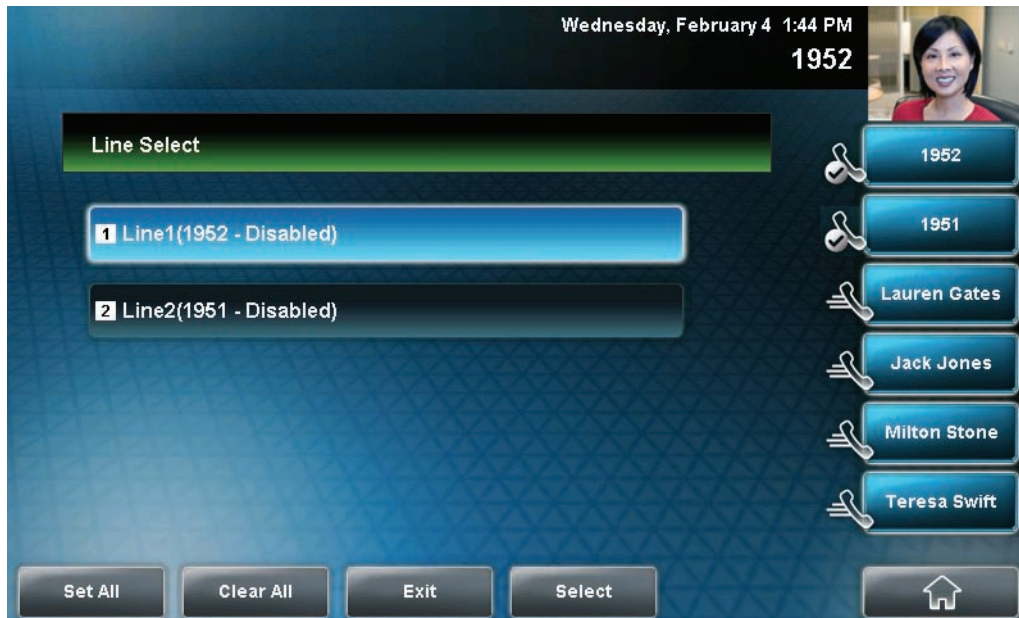
**Note**

You can automatically enable or disable Do Not Disturb for all lines. To automatically enable Do Not Disturb for all lines, tap the **Set All** soft key. To automatically disable the feature for all lines, tap the **Clear All** soft key. After you tap the Set All or Clear All soft key, the idle screen displays.

2. Tap the line for which you want to apply Do Not Disturb.
The Do Not Disturb screen displays.

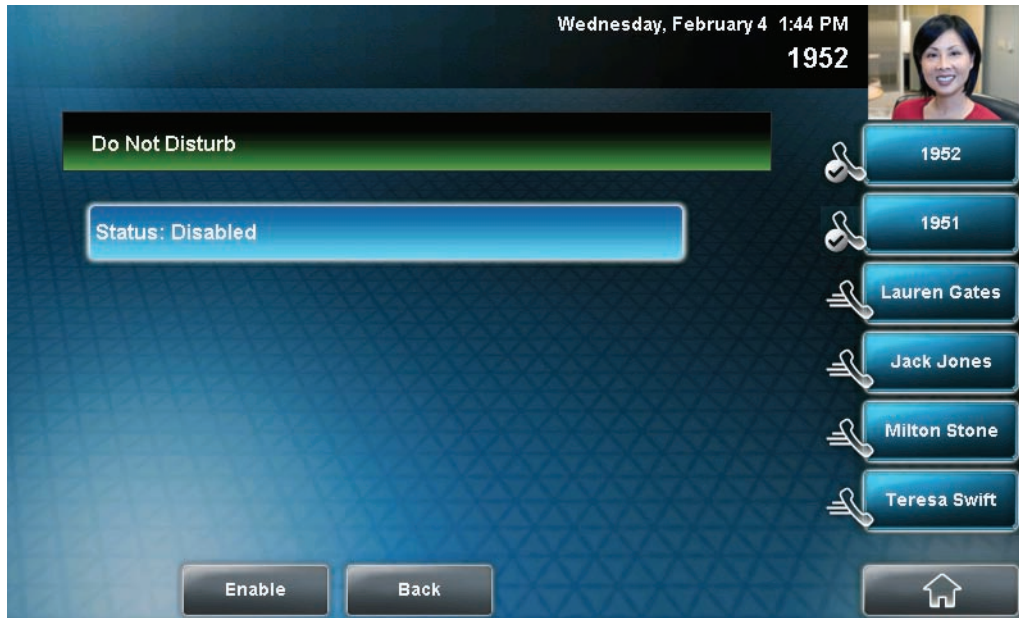

3. Tap the **Enable** soft key.

The Do Not Disturb icon, , displays on each Line Key for the line you selected.

The following figure shows Do Not Disturb enabled for one line only.

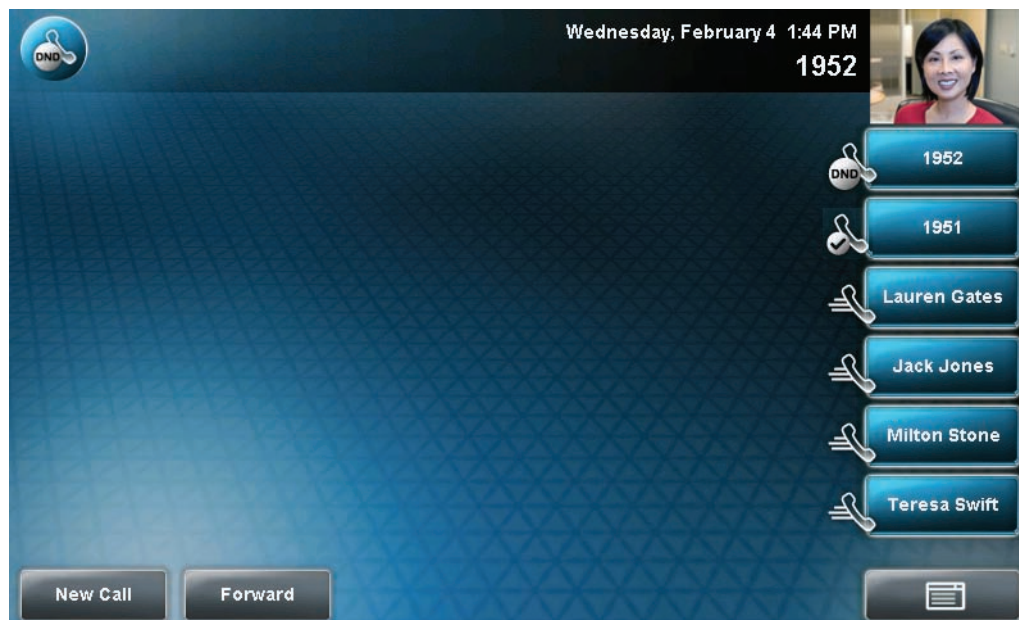

To disable Do Not Disturb for a particular line:

1. Tap  or press .

The Line Select screen displays.

**Note**

You can automatically enable or disable Do Not Disturb for all lines. To automatically enable Do Not Disturb for all lines, tap the **Set All** soft key. To automatically disable the feature for all lines, tap the **Clear All** soft key. After you tap the Set All or Clear All soft key, the idle screen displays.

2. Tap the line for which you want to disable Do Not Disturb.
The Do Not Disturb screen displays.



3. Tap the **Disable** soft key.

Managing Speed Dial Keys

You can associate contacts with Speed Dial Keys for single touch dialing of frequently used numbers. Speed Dial Keys display .

The following figure shows a phone with two Line Keys (1951 and 1952), and four Speed Dial Keys (assigned to Lauren Gates, Jack Jones, Milton Stone, and Teresa Swift).



When a new entry is added to the Contact Directory, it is automatically assigned a speed dial index number, as well as the next available position under the Line Key(s). The phone populates all available positions with the contacts that have the lowest speed dial index numbers.

Speed Dial Keys display consecutively according to the speed dial index number (the lowest speed dial index number displays first). To re-order Speed Dial Keys, see [Updating Speed Dial Keys](#) on page 3-40.

For information on assigning or updating speed dial index numbers, see [Updating Contacts in Your Local Contact Directory](#) on page 2-56. For information on placing calls using speed dials, see [Placing Calls Using Speed Dial](#) on page 3-10.

Adding Speed Dial Keys

Each time you add a contact to your Contact Directory, a speed dial index number is automatically assigned to the contact. If a position is available under the Line Key(s), the contact is automatically assigned to it, and you can place a call to the contact by tapping the Speed Dial Key.

To assign a new Speed Dial Key:

1. Tap  > **Features** > **Contact Directory**.
2. Tap the **Add** soft key.
3. Add contact information for the new contact (see [Adding Contacts to Your Local Contact Directory](#) on page 2-46).

The speed dial index can be any value between the next available number and a maximum value of 9999.

If you assign a speed dial index number that is already taken, the message “Speed dial index already exists” displays.



Polycom recommends that you assign speed dial index values consecutively. For example, if you assign the third position to the speed dial index value “2,” assign the fourth position to the speed dial index value “3.”

4. Tap the **Save** soft key.
5. Tap  to return to the idle screen.

Updating Speed Dial Keys

Update a Speed Dial Key to remove or re-order the Speed Dial Keys on your phone. You update a Speed Dial Key by updating a contact’s speed dial index number. If you delete a speed dial index number for a contact, the contact’s Speed Dial Key is replaced by the contact who has the closest speed dial index number.

To update a speed dial index for an existing contact:

1. Tap  > **Features** > **Contact Directory**.
2. Tap the contact whose speed dial index you want to update, and then tap the **Edit** soft key.

The Edit Contact screen displays.



3. Tap the **Speed Dial Index** field, and then enter or update the speed dial index number.

The speed dial index can be any value between the next available index value and a maximum value of 9999.

4. Tap the **Save** soft key.
5. Tap  to return to the idle screen.

Accessing Voice and Video Mail



Note

Voice and video mail is an optional feature that your system administrator sets up. Your system may not support it. For more information, contact your system administrator.

Screen options may vary with your application. Voice/video mail may be accessible with a single key press. Contact your system administrator about this option.

You can access voice and video mail messages from your phone. Your mail is saved in a centralized location.

Your phone may indicate mail by the following:

- An icon, , on the status bar. The icon has a counter indicating the number of unviewed messages you have.
- An icon, , next to the Line Key.
- A fast flashing LED indicator.
- An audible alert (if your phone is on-hook).

To listen to voice or video messages:

1. Do one of the following:

- To review new messages, tap  > **Message Center**.

or

- To review old messages, tap  > **Features** > **Messages** >

Message Center. Or, press , and then tap **Message Center**.

The Messages screen displays.

(If multiple lines are set up on your phone, the Line Select screen displays instead, and you have to tap the line for which to listen to messages. Then, the Messages screen displays.)

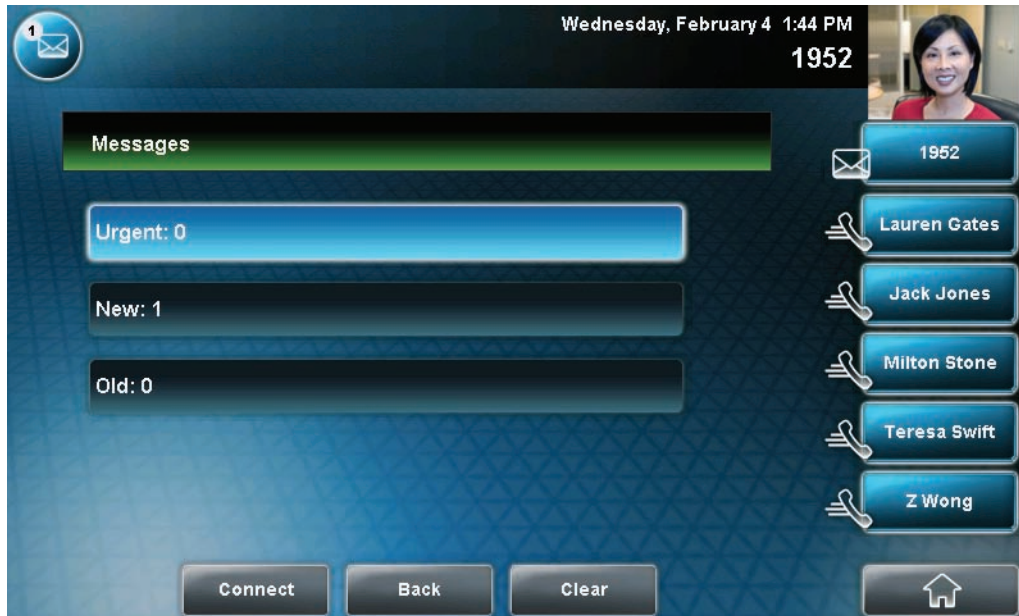

2. To access your mail, tap the **Connect** soft key, and then follow the voice or visual prompts on the screen.

To remove all messages from your mailbox, tap the **Clear** soft key.

3. Tap  to return to the idle screen.

Using the Advanced Features of Your Phone

This chapter shows you how to use the advanced features of the Polycom VVX 1500 desktop phone. The topics include:

- [Using Instant Messaging](#) on page 4-1
- [Using Buddy Lists](#) on page 4-6
- [Using the Busy Lamp Field](#) on page 4-16
- [Recording Calls](#) on page 4-17
- [Playing Back Recorded Calls](#) on page 4-23
- [Using the Launch Pad](#) on page 4-30
- [Restarting Your Phone](#) on page 4-33

To customize your phone, refer to [Customizing Your Phone](#) on page 2-1. To read about the phone's basic features, refer to [Using the Basic Features of Your Phone](#) on page 3-1.

If you require additional information or assistance with your new phone, contact your system administrator.



Using Instant Messaging

Note

Instant messaging is an optional feature that your system administrator enables. Your system may not support it. For more information, contact your system administrator.

You can send and receive instant messages using your phone. Instant messaging is supported in real-time.

Your phone may indicate instant messages by the following:

- An icon, , on the status bar. The icon has a counter indicating the number of unviewed messages you have.
- An icon, , next to the Line Key.
- A fast flashing LED indicator.
- An audible alert (if your phone is on-hook).

Reading and Managing Instant Messages



Messages display in the order they are received (the first message received displays first).

To read instant messages:

Note

Screen options may vary with your application. Instant messaging may be accessible with a single key press. Contact your system administrator about this option.

1. Do one of the following :

- Tap  > **Instant Messages**.
- Tap  > **Features** > **Messages** > **Instant Messages**.
- Press , and then tap **Instant Messages**.

The Instant Messages screen displays.

(If multiple lines are configured on your phone, the Line Select screen displays instead, and you have to select the line to retrieve messages from. Then, the Instant Messages screen displays.)

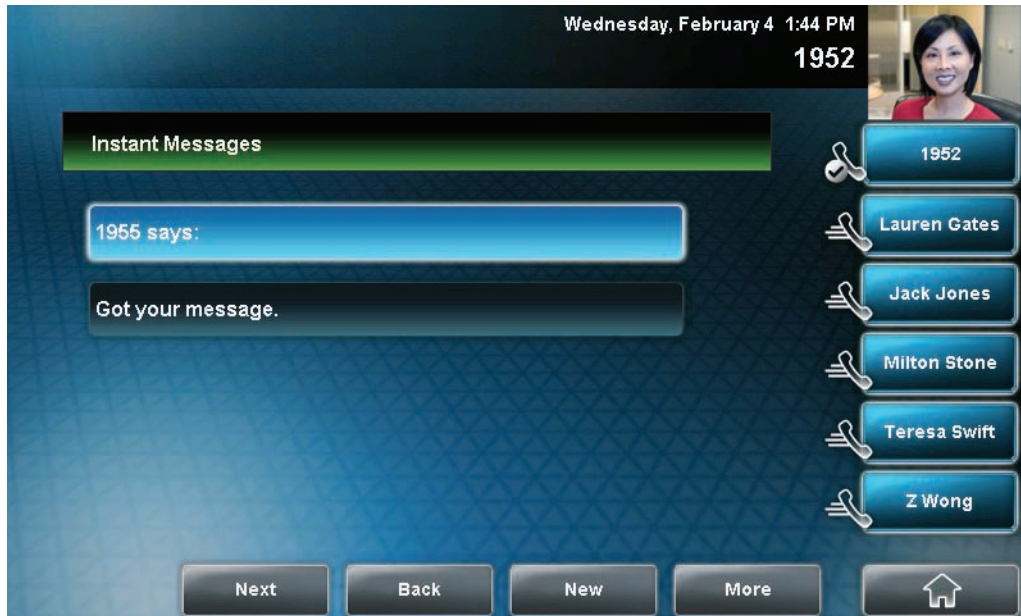

2. From the Instant Messages screen, you can do the following:
 - Tap the **Next** or **Previous** soft key to view a specific message. The first message received displays first.
 - To create a new message, tap the **New** soft key (see [Sending Instant Messages](#) on page 4-3).
 - To reply to the message, tap the **Reply** soft key (see [Sending Instant Messages](#) on page 4-3, step 3).
 - To delete the message, tap the **Delete** soft key.
3. Tap  to return to the idle screen.

Sending Instant Messages



When you send a message, you can either select a message from a preset list of short messages (for example, “Call me” and “Can’t chat now”), or you can use the dialpad to type a custom message.

To send an instant message:

Note

Screen options may vary with your application. Instant messaging may be accessible with a single key press. Contact your system administrator about this option.

1. Do one of the following:

- Tap  > **Instant Messages**.
- Tap  > **Features** > **Messages** > **Instant Messages**.
- Press , and then tap **Instant Messages**.

The Instant Messages screen displays.

(If multiple lines are configured on your phone, the Line Select screen displays instead, and you have to select the line to send the message from. Then, the Instant Messages screen displays.)

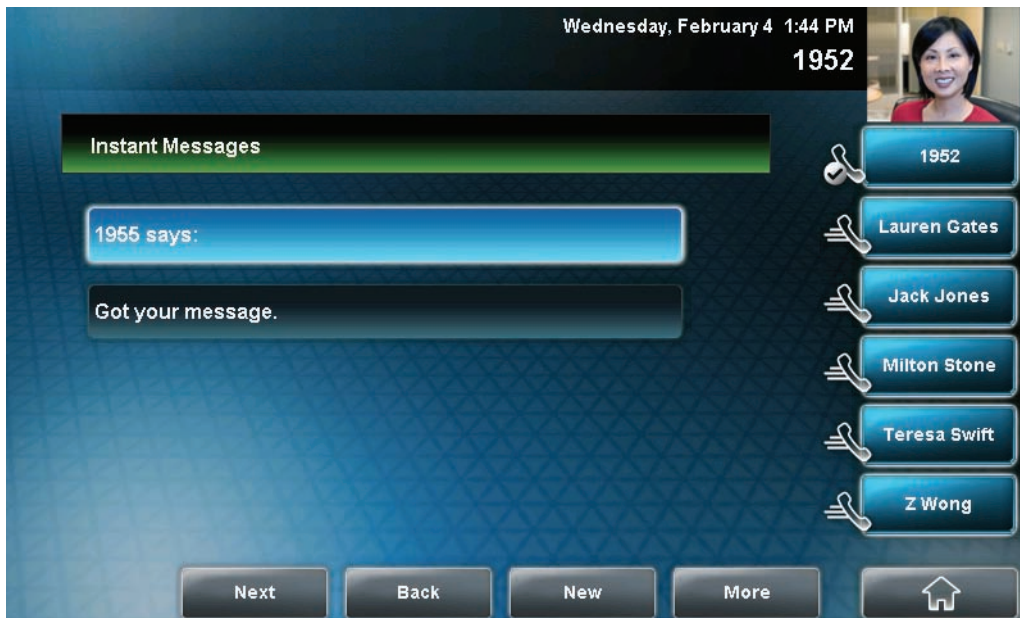

2. Tap the **New** soft key, enter the phone number, URL, or IP address to send the message to, and then tap the **Ok** soft key.

The phone number, URL, or IP address you entered displays on the screen.



3. Do one of the following:
 - To choose a pre-scripted message, tap the **Select** soft key. From the Message Select screen, tap the message you want.
 - or
 - To compose a custom message, tap the **Edit** soft key, and then enter your message. (For information on entering data, see [Entering Data and Editing Fields](#) on page 1-27.)
4. Tap the **Send** soft key.
5. Tap  to return to the idle screen.

Using Buddy Lists

Note

Monitoring the status (presence) of contacts is an optional feature that your system administrator enables. Your system may not support it. For more information, contact your system administrator.

A buddy list is a list of users/devices whose status, or “presence,” you can monitor. Users update their presence setting (for example, “Be right back,” “Out to lunch,” or “Busy”), and you can view their status in real time from your phone’s Buddy Status screen, or from the idle screen (if your buddy has a Speed Dial Key on your phone). If you like, you can block others from monitoring your status.

Your phone can “watch” the status of up to eight other phones, or 48 buddies. These phones form your “Buddy List.” Your phone can be monitored by up to eight other phones.

If your phone is configured to work with Microsoft Office Live Communications Server 2005, the behavior of presence settings and buddy lists is different. For more information, see [Integrating With Microsoft Live Communications Server 2005](#) on page 4-14, or contact your system administrator.

Updating Your Presence Settings

Your presence setting indicates your status (either online, busy, be right back, away, out to lunch, offline, or do not disturb). Update your presence setting so that other users can monitor your status from their phones.

When you select a presence setting (other than online), the setting displays on the status bar on your phone.

To update your presence settings:

1. Do one of the following:
 - Tap the **My Status** soft key.
 - or
 - Tap  > **Features** > **Presence** > **My Status**.

The My Status screen displays.

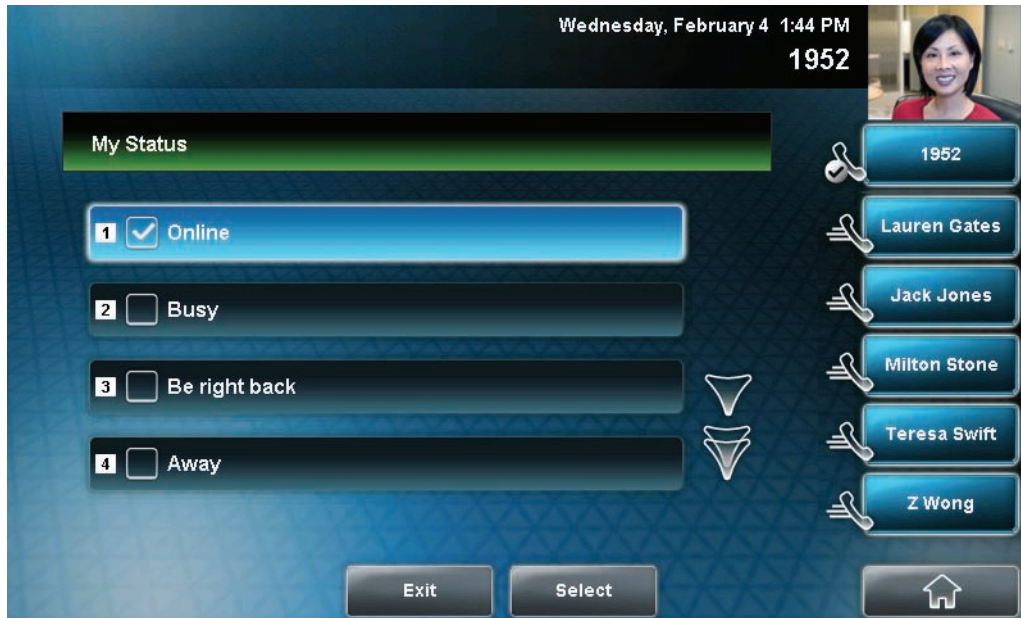

2. Tap the status you want, and then tap the **Select** soft key.

This affects information sent to phones watching you. Presence information will also be sent to watching phones when you go off-hook or enable Do Not Disturb.

3. Tap  to return to the idle screen.

The status you selected displays on the status bar (unless you selected Online).

The following figure shows what the touch screen looks like when you assign a presence status (in this case, “Busy”). If you assign the status “Online” (the default status), the presence status does not display on the screen.

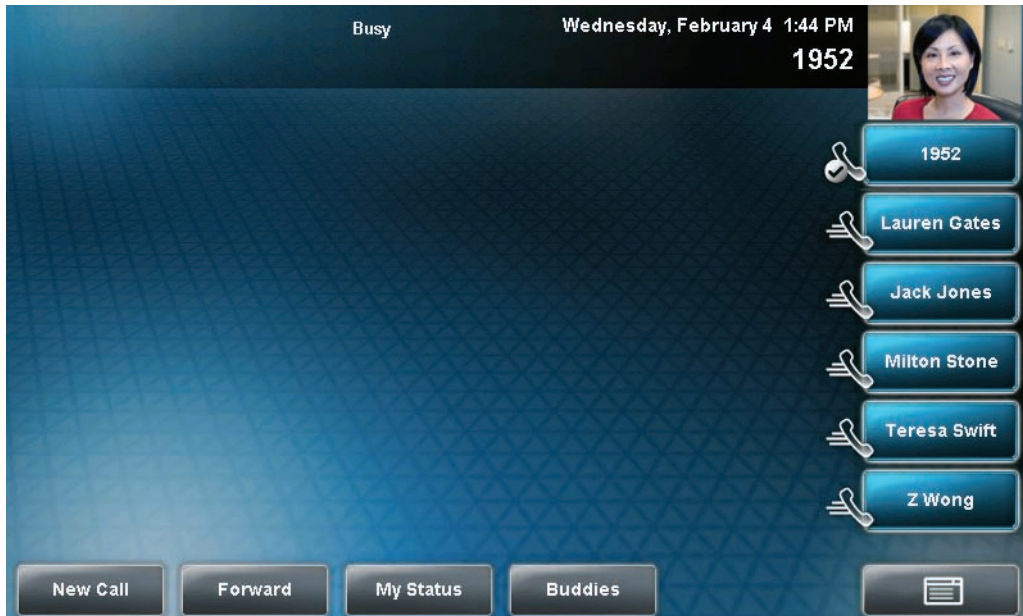

Managing Buddies

Manage your buddies by selecting the contacts whose presence you want to monitor. These contacts form your buddy list. You add contacts to your buddy list from your local Contact Directory.

When you select a buddy, a Speed Dial Key is automatically assigned to the buddy (if one is available), and the Speed Dial Key will display the buddy's status. If the contact you choose as a buddy already has a Speed Dial Key, the contact's Speed Dial Key will display the buddy's status.

Note

If your call server is Microsoft Live Communications Server 2005, see [Integrating With Microsoft Live Communications Server 2005](#) on page 4-14.

Updating Your Buddy List

Update your buddy list by updating the contacts in your local Contact Directory.

To update your buddy list:

1. Tap  > **Features** > **Contact Directory**.

The Directory screen displays.



2. Tap the contact you want to monitor or stop monitoring, and then tap the **Edit** soft key.

The Edit Contact screen displays.

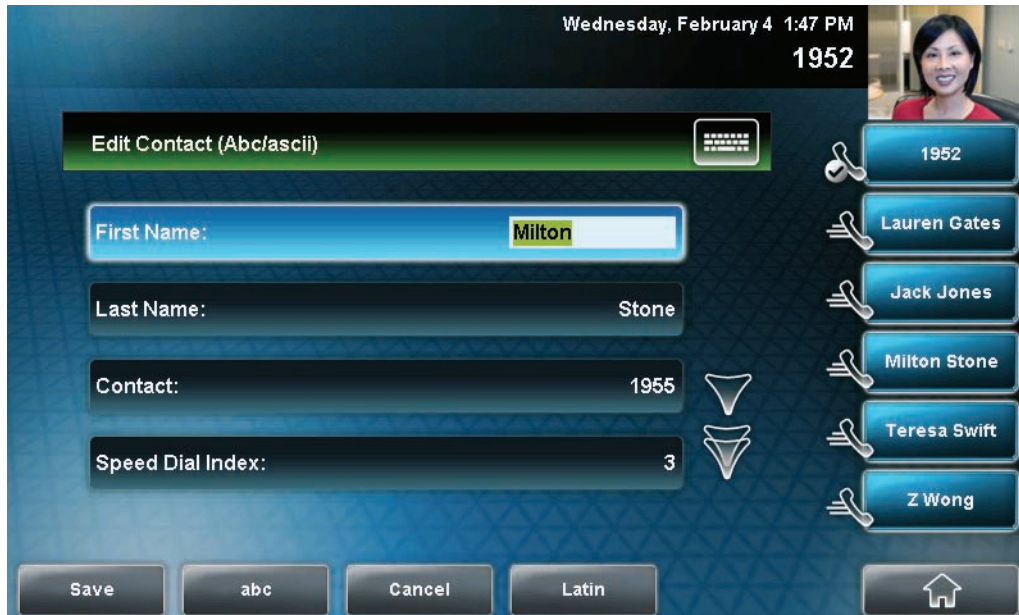

3. Tap the **Watch Buddy** field, and then tap the field's highlighted grey box. From the drop-down list, tap **Enabled** or **Disabled**.

When Watch Buddy is enabled, the contact is added to your buddy list and you can monitor the contact's status.

When Watch Buddy is disabled, the contact is removed from your buddy list and you cannot monitor the contact's status.

The default for Watch Buddy is Disabled.

4. Tap the **Save** soft key.
5. Tap  to return to the idle screen.

If you enable the Watch Buddy setting for a contact, the contact will display on your Buddy Status screen, and on the idle screen (if your buddy has a Speed Dial Key). To view your Buddy Status screen, tap the **Buddies** soft key from the idle screen.

Blocking and Unblocking Contacts from Viewing Your Status

Block a contact in your Contact Directory if you don't want the contact to view your status. If you unblock a contact, the contact can add you to their buddy list and view your status.

Note

To view a list of contacts that can and cannot monitor your status, do the following:

- To view contacts that cannot view your status, press the **Menu** key, and then tap **Features > Presence > Blocked List**.
- To view contacts that can view your status, press the **Menu** key, and then tap **Features > Presence > Watcher List**.

To block or unblock a contact from viewing your status:

1. Tap  > **Features > Contact Directory**.

The Directory screen displays.



2. Tap the contact you want to block or unblock.
The Edit Contact screen displays.



3. Tap **Block Buddy**, and then tap the field's highlighted grey box. From the drop-down list, tap **Enabled** or **Disabled**.

When Block Buddy is enabled, the contact cannot watch your status. The contact will display in your Blocked List.

When Block Buddy is disabled, the contact can watch your status. The contact will display in your Watcher List.

The default for Block Buddy is Disabled.

4. Tap the **Save** soft key.
5. Tap  to return to the idle screen.

Note

You can use your Blocked List to unblock a contact, rather than updating the Contact Directory. Press the **Menu** key, and then tap **Features > Presence > Blocked List**. From the Blocked List screen, tap the contact you want to unblock, and then tap the **Unblock** soft key. The contact can now watch your phone, and will display in your Watcher List.





Monitoring Buddies

You can monitor the status of all the contacts in your buddy list from the idle screen (if your buddy has a Speed Dial Key), or from the Buddy Status list.

Monitoring Buddies from the Idle Screen

Your phone automatically assigns a buddy to a Speed Dial Key (if one is available). The Speed Dial Key displays an icon and status indicator (a vertical bar on the far-right of the key) that indicate the buddy's status.

The following table shows the presence icons and status indicators that display on the Speed Dial Key to indicate a buddy's status.

| Buddy Status | Speed Dial Key Icon | Status Indicator |
|------------------------------------|-------------------------------------------------------------------------------------|------------------|
| Online |  | (No indicator) |
| Busy/Do Not Disturb |  | Solid red |
| Away/Be Right Back Out to Lunch |  | Flashing red |
| Offline |  | Solid red |

The following figure shows a phone that is monitoring two buddies: Lauren Gates and Jack Jones. Lauren Gates is Online, and Jack Jones is either Away, Out to Lunch, or Be Right Back.



Monitoring Buddies from the Buddy List

If you can't monitor all your buddies from the idle screen (because you have more buddies than available Speed Dial Keys), use the Buddy Status list.

To monitor a contact in your buddy list:

>> Do one of the following:

- Tap the **Buddies** soft key.

or

- Tap  > **Features** > **Presence** > **Buddy Status**.

The Buddy Status screen displays, listing the status of all your buddies.

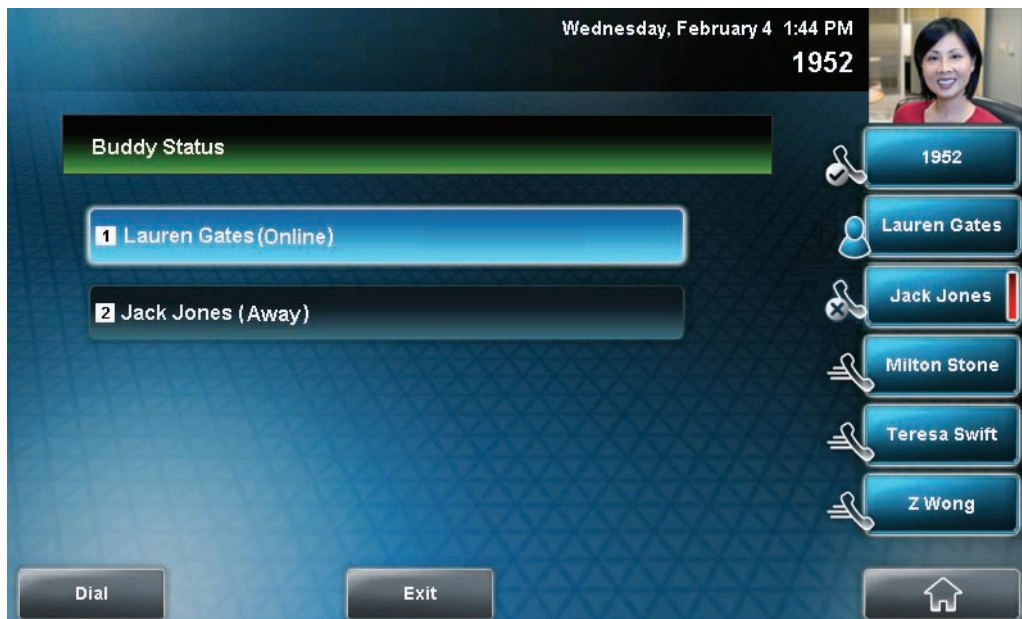



Integrating With Microsoft Live Communications Server 2005

Your system administrator can configure your phone to work with Microsoft Live Communications Server 2005 and communicate with others using Microsoft Office Communicator and Windows Messenger. From your phone, you can invite, join, control, and monitor integrated multipoint audio and video conferences.

Any contact you add through your buddy list will appear as a contact in Microsoft Office Communicator and Windows Messenger. Any contact you add as a contact in Microsoft Office Communicator and Windows Messenger will appear in your buddy list. You can access your Privacy List on the phone to allow or disallow your contacts from monitoring your presence.

To view and change your presence, see [Updating Your Presence Settings](#) on page 4-6. For more information on integrating with Microsoft Live Communications Server 2005, contact your system administrator.

To add a contact to your buddy list:

1. Tap  > **Features** > **Presence** > **Buddy Status**.
2. Tap the **Add** soft key.
3. Enter the phone number of the contact.
4. Tap the **Submit** soft key.
5. Tap  to return to the idle screen.

To view and change your privacy list:

1. Tap  > **Features** > **Presence** > **Buddy Status** > **Privacy List**.
2. Tap the contact whose access you want to update.
3. Tap the **Edit** soft key.
4. Tap the **Access** field, and then tap the field's highlighted grey box. From the drop-down list, tap **Enabled** or **Disabled**.

When Access is enabled, you allow the contact to see your presence.

When Access is disabled, you prevent the contact from seeing your presence.

The default for Access is Disabled.

5. Tap  to return to the idle screen.

For more information, see the Microsoft Office Communicator and Windows Messenger documentation.



Using the Busy Lamp Field

Note

Busy Lamp Field (BLF) is an optional feature that your system administrator sets up. Your system may not support it.

The BLF feature allows you to monitor a line on another phone so you can tell if the other line is idle or busy (has an active call). The lines you can monitor display under your phone's Line Key(s). The number of lines you can monitor is determined by the number of lines your phones has. For example, if your phone has one line assigned to one Line Key, then you can monitor up to five other lines.

The following table shows the BLF icons and status indicators that display when you monitor a line on another phone.

| BLF Status | Line Key Icon | Status Indicator |
|------------|------------------------------------------------------------------------------------|------------------|
| Idle |  | (No indicator) |
| Busy |  | Solid red |

The following figure shows two remote lines. Line 1953 is idle and Line 4002 is busy.

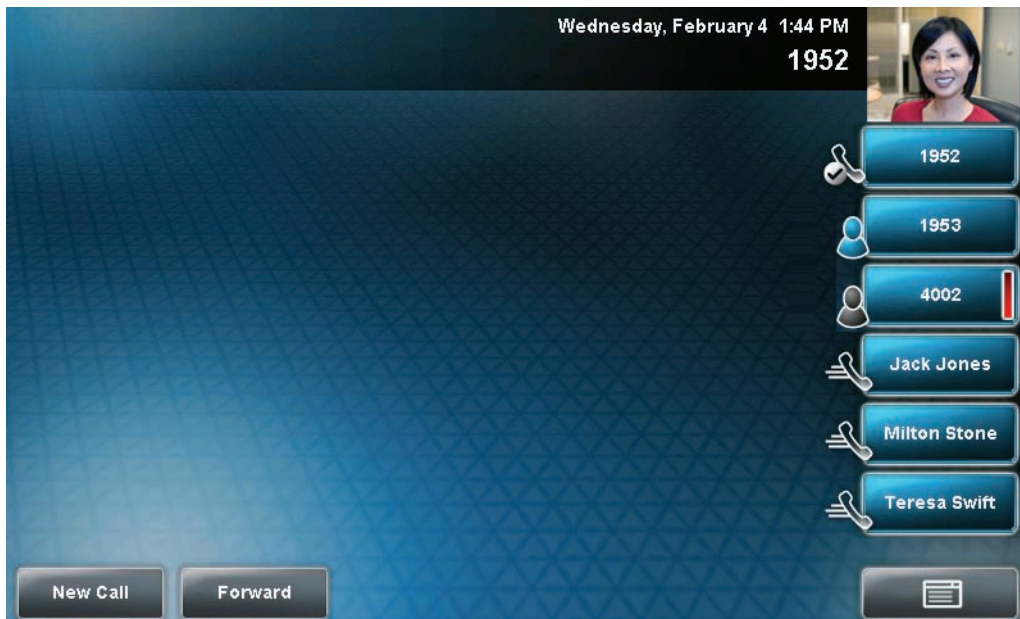

Recording Calls

Note

Recording calls is an optional feature that your system may not support. For more information, contact your system administrator.

When you record a video call, your phone will only record the audio component.



For a list of supported USB devices to record phone audio, see Technical Bulletin 38084, *Supported USB Devices for SoundPoint IP 650/670 and Polycom VVX 1500 Phones*, at http://www.polycom.com/support/voice/soundpoint_ip/VoIP_Technical_Bulletins_public.html.

If the Call Recording and Playback feature is available, and you connect a USB device to the USB port on your phone, you can record active calls (audio component only) on your phone. Recordings are stored as **.wav** files on the USB device. You can record up to four hours in one file. The approximate time remaining for recording (the free space on the USB device) is shown on the status bar of the phone screen.

The following figure shows that you have 16.7 hours of free space on your USB device.



The **Record** soft key controls recording and is available:

- When there are one or more calls connected to your phone (you may need to tap the **More** soft key to see it)
- During an active call
- When calls are on hold
- During a consultative transfer or conference call

The **Record** soft key is not available:

- When there are no connected calls on your phone
- When you place a new call (to transfer or to conference)
- When the phone prompts you to answer an incoming call

If you put an active call on hold, recording pauses. Recording continues if the called party puts you on hold. Recording stops if all active calls end, no matter who ends the calls.

If you press  while recording, only the called parties are recorded.

Tones and indications (for example, dialing of digits or ringing from another party's phone) that occur before a call connects are not recorded. Local tones and indications (for example, DTMF tones when dialing) are not recorded. However, tones from another party's phone may be recorded.

You control recording by tapping the Start, Pause, Resume, and Stop soft keys. All active calls that occur on your phone between the time you tap the Start soft key and the Stop soft key are recorded, alternating in the same **.wav** file.

For example, on October 4, 2007 at 11:22 am, you place a call to party A. After party A answers, you start recording the call. While you speak with party A, an incoming call arrives. You place party A on hold and speak with party B. When you finish speaking with party B, you return to speaking with party A. While speaking with party A again, another incoming call arrives. You place party A on hold and speak with party C. When you finish speaking with party C, you return to speaking with party A. You end your call with party A, and recording stops.

Your conversations with parties A, B, and C are all recorded in the same **.wav** file as follows:

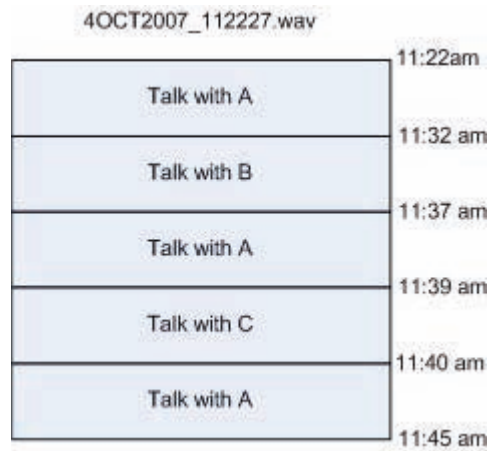

If you record, or attempt to record, a call, the following messages may appear on your screen:

- If there is insufficient free space on the USB device when you tap the Start soft key, recording does not start and the following message displays:
"USB device is full. Recording cancelled."
- If the USB device becomes full during recording, recording stops and the following message displays:
"USB device is full. Recording stopped."
- If you remove the USB device during recording, recording stops and the following message displays:
"USB device removed unsafely. Recording cancelled."
- If you attach an unsupported USB device, the following message displays (along with information about the unsupported product):
"Unsupported USB device attached."



Polycom recommends that you do not remove the USB device while recording. The file being recorded will be incomplete and cannot be played back later. There is a small probability that the USB device itself may be damaged by this action.

Note

If you connect the USB device to your phone and the message "Unsupported USB device attached" displays, see your system administrator about the USB devices your phone supports.

Note

You may be required by federal, state, and/or local laws to notify some or all called parties when you record calls (either one-party or all-party consent). You can find specific information about US state requirements at <http://www.rcfp.org/taping/>. Telephone call recording regulations in other countries vary widely. Polycom recommends checking with the local government's telecommunications authority and government legal agencies.

You can find other information that may useful at:

- <http://www.fcc.gov/cgb/consumerfacts/recordcalls.html>
- <http://www.privacyrights.org/fs/fs9-wrtp.htm>

This section includes the following topics:

- [Recording Calls](#)
- [Recording Conferences](#)
- [Pausing and Resuming Recording](#)

To play back recorded calls, see [Playing Back Recorded Calls](#) on page 4-26.

Recording Calls

To record a call:

1. During a call, tap the **Record** soft key.
The Start soft key displays.



2. To start recording, tap the **Start** soft key.
 “*R*” displays on the status bar while the phone records.



To access the top-level soft keys (for example, Hold, End Call, Transfer, and Conference), tap the **Back** soft key. To access the Stop and Pause soft keys again, tap the Record soft key.

3. To stop recording, do one of the following:
 - Tap the **Stop** soft key. Then, tap the **Back** soft key to access the top-level soft keys.
 - or
 - To end the call, tap the **Back** soft key, and then tap the **End Call** soft key.
 - or
 - To end the call, hang up.

Recording Conferences

You can record conference calls in the same way as other calls with the following exceptions:

- All parties in a conference call are recorded. If one of the conference parties presses , that party is not recorded.
- When a conference call is placed on hold, recording is paused. You can place or answer other calls, which will be recorded in the same file. When the conference call is resumed, recording of the conference resumes.

Pausing and Resuming Recording

You can pause recording by tapping the Pause soft key. When you tap the Resume soft key, recording continues within the same .wav file.

To pause a recording:

>> Tap the **Pause** soft key.

“*P*” displays on the status bar when you pause recording.



To resume a recording:

>> Tap the **Resume** soft key.

“*R*” displays on the status bar when you restart recording.





Playing Back Recorded Calls

Note



Call Playback is an optional feature and may not be supported on your particular system. For more information, see your system administrator.

If the Call Recording and Playback feature is available, and a removable USB device is connected to your phone, you can play back calls that you recorded on your phone.

You can browse the recorded files, stored as **.wav** files, on the USB device. You can also open, rename, and delete the recorded files. If there are no supported **.wav** files on the USB device, the message “Unsupported wav file format” appears on the screen.

Playback occurs in real time. To adjust the volume of the receiver audio during playback, press  or  .

Playback stops if you tap the **Back** soft key, or press the **Left** arrow key, ,

, or .

If the handset is off-hook when you tap the **Play** soft key, you will hear audio through the handset. If the handset is on-hook when you tap the **Play** soft key, you will hear audio through the speaker. If you lift the handset while you listen through the speaker, you will hear the audio through the handset.

You cannot open a **.wav** file while a call is in progress or if you have placed a call. The message “Active call, action aborted” displays in either case. If all

calls are on hold, you can start playback. If you press  for the selected call or the particular Line Key for the held call, playback stops and the call resumes.

You cannot place a call while playback is in progress using the dialpad. However, you can place a call using a speed dial key or Line Key. You can answer calls while playback is in progress (see [Answering a Call While Playing Back Recorded Calls](#) on page 4-28).

You can also play back recorded files on other devices, such as a Windows® or Apple® based computer using an application capable of playing **.wav** files.

If an error occurs while playback is in progress, playback stops. If you remove the USB device during recording, recording stops and the message “Storage media removed unsafely. Recording cancelled” displays. If you attach an unsupported USB device, the message “Unsupported USB device attached” appears.



Polycom recommends that you do not remove the USB device while playing back files. There is a small probability that the USB device itself may be damaged by this action.

Note

If you connect your USB device to your phone and the message “Unsupported USB device attached” displays, contact your system administrator about which USB devices are supported. To see a list of supported USB devices to record phone audio, see Technical Bulletin 38084, *Supported USB Devices for SoundPoint IP 650/670 and Polycom VVX 1500 Phones*, at http://www.polycom.com/support/voice/soundpoint_ip/VoIP_Technical_Bulletins_public.html.

This section includes information on:

- [Browsing Recorded Calls](#)
- [Playing Back Recorded Calls](#)
- [Answering a Call While Playing Back Recorded Calls](#)

Browsing Recorded Calls

To browse the recorded files:

1. Do one of the following:

- Tap  > **Browse Recordings**.

or

- Tap  > **Features** > **Removable Storage Media** > **Browse Recordings**.

The Browse Recordings screen displays.



2. Tap the recording you want to rename, delete, or play back.

You can rename, delete, or play back the selected **.wav** file by tapping the **Rename**, **Delete**, or **Open** soft keys.

3. Tap  to return to the idle screen.

Playing Back Recorded Calls

To play back a recorded call:

1. Do one of the following:

– Tap  > **Browse Recordings**.

or

– Tap  > **Features** > **Removable Storage Media** > **Browse Recordings**.

The Browse Recordings screen displays.



2. Tap the file you want to play back, and then tap the **Open** soft key. The filename you selected displays. The length of the file (in hours, minutes, and seconds) and the size of the file also display.

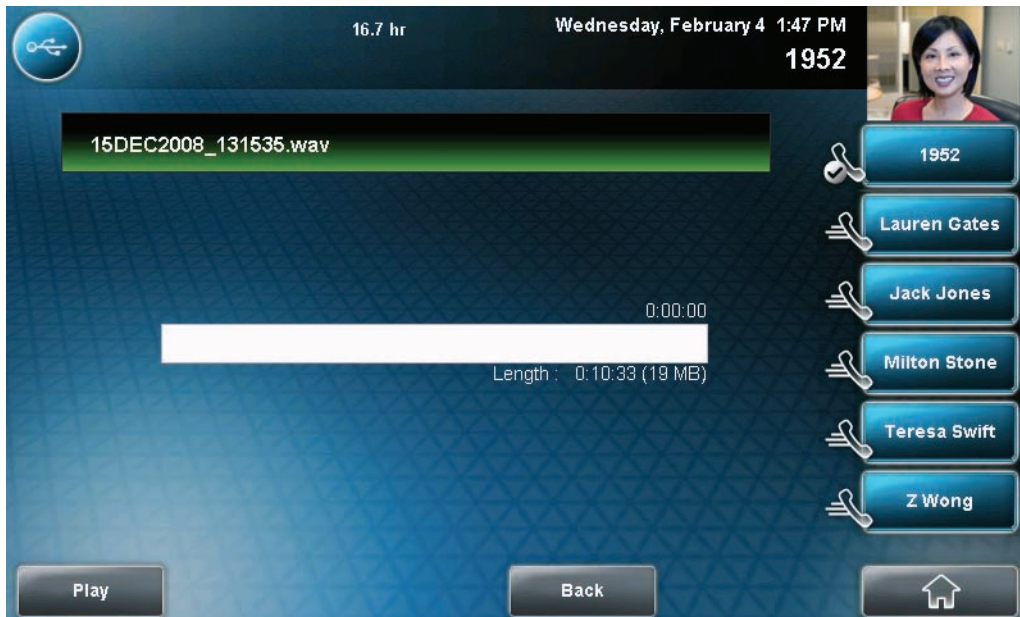

3. Tap the **Play** soft key. "Playing" displays on the screen. The position indicator (in hours, minutes, and seconds) above the progress bar changes as the file plays back in real time.

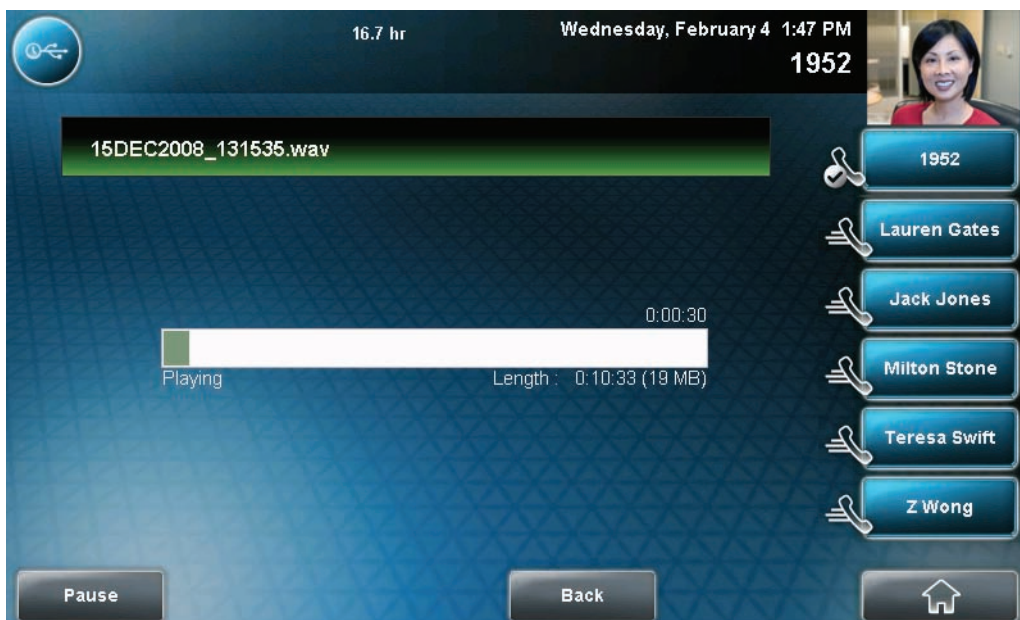

While the recording plays, you can do the following:

- To pause the playback, tap the **Pause** soft key.
“Paused” displays below the position indicator.

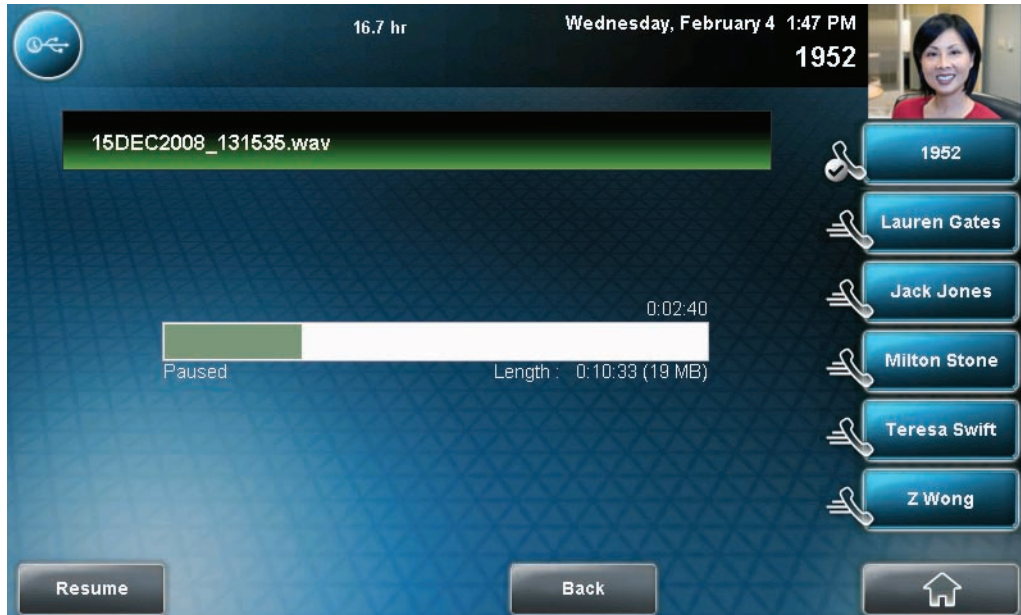

To resume the playback, tap the Resume soft key.

- To stop playing back the file, tap the **Back** soft key.

4. Tap  to return to the idle screen.

Answering a Call While Playing Back Recorded Calls

If you are playing back a file and an incoming call arrives, playback pauses and the phone rings. If you don't answer your phone, playback remains paused, and you must tap the Resume soft key to continue playback.

To answer a call using the speakerphone:

>> Do one of the following:

- If you were listening to the file with the handset or headset, press



- If you were listening to the file with the speakerphone, tap the Line Key with the flashing green status indicator.
- If you were listening to the file with the speakerphone, tap



, and then tap the **Answer** soft key.

When the call ends, the idle screen displays.

To answer a call using the handset:



>> Do one of the following:

- If you were listening to the file with the speakerphone or a headset, lift the handset.
- If you were listening to the file through the handset, hang up the handset, and then pick it up again.
- If you were listening to the file through the handset, tap the Line Key with the flashing green status indicator.
- If you were listening to the file through the handset, tap , and then tap the **Answer** soft key.

When the call ends, the idle screen displays.

To answer a call using the headset:

>> Do one of the following:

- If you were listening to the file with the speakerphone or a headset, press  .
- If you were listening to the file with the headset, tap the Line Key with the flashing green status indicator.
- If you were listening to the file with the headset, tap , and then tap the **Answer** soft key.

Note

If you use a digital headset with an answer button, or an analog headset with an electronic switch, use the button or switch to answer the incoming call.

When the call ends, the idle screen displays.

If you decide to reject the incoming call, tap the **Resume** soft key, and playback will resume. For more information, see [Playing Back Recorded Calls](#) on page 4-26.

Using the Launch Pad

Your phone's Launch Pad allows you to access local or web applications such as the Picture Frame application, local directories, and information feeds from your phone. Your system administrator can customize the applications you see.

By default, Launch Pad displays the following applications:

- Picture Frame (if the Picture Frame feature is enabled for your phone) – to display the pictures you have on a USB flash drive. Using the Picture Frame application, you can display your pictures as thumbnails, one-by-one (like a slide show), or display just one picture. You can also use the Picture Frame application to set one of your pictures as the background image on your phone. (For information on how to use Picture Frame, see [Displaying the Pictures that are Stored on Your USB Flash Drive](#) on page 2-14.)
- My Info Portal (hosted by Polycom) – to give you access to a variety of information feeds (for example, sports, news, weather, stock, and traffic). My Info Portal demonstrates the use of web services with your phone using Polycom XML APIs. Before you use My Info Portal, you have to enable it (see [Enabling My Info Portal](#) on page 4-32).

Your system administrator can set up your phone so that you can view feeds from the idle screen, as well as from Launch Pad.

Note

When you view feeds (either from Launch Pad or from the idle screen), your phone is considered idle, and a screen saver (if it is set up) will still display.

Accessing Launch Pad

You access Launch Pad from the Applications menu.

To access applications using the Launch Pad:

1. Tap  > **Applications**, or press .

The Launch Pad's main window displays.

By default, the Picture Frame application (if it is enabled for your phone) and My Info Portal application display. Your system administrator may have configured other applications or information to display.

Note

If you previously exited a Launch Pad application without first returning to the Launch Pad's main window, or if a Launch Pad window times out, the next time you access Launch Pad, the last window you viewed will display, not the Launch Pad's main window. To display the Launch Pad's main window, tap the **Home** or **LaunchPad** soft key.

The following figure shows the Launch Pad's main window.



2. Do one of the following:

- To launch Picture Frame, tap the Picture Frame icon.

For information on how to use Picture Frame, see [Displaying the Pictures that are Stored on Your USB Flash Drive](#) on page 2-14.

- To launch My Info Portal, tap the My Info Portal icon, and then tap the feed you want to view. (If you haven't enabled the My Info Portal application yet, you will have to set up an account before you can access the application. See [Enabling My Info Portal](#) on page 4-32).
- To launch another application, tap it.

For information on using other applications, see your system administrator.

From Launch Pad, you can do the following:

- To display the Launch Pad's main window (with all the Launch Pad applications), tap the **Home** soft key.
- To refresh the Launch Pad window so you can access an updated application, tap the **Refresh** soft key.
- To launch the previous application you viewed, tap the **Back** soft key.
- To return to the idle screen, tap the **Exit** soft key.

Enabling My Info Portal

Before you can access the applications under My Info Portal, you have to sign up for a My Info Portal account.

Note

Information you provide when you set up an account is securely transmitted using the HTTPS security protocol.

To enable My Info Portal:

1. Tap  > **Applications**, or press .

The Launch Pad's main window displays.

Note

If you previously exited a Launch Pad application without first returning to the Launch Pad's main window, or if a Launch Pad window times out, the next time you access Launch Pad, the last window you viewed will display, not the Launch Pad's main window. To display the Launch Pad's main window, tap the **Home** or **LaunchPad** soft key.



2. Tap the **My Info Portal** icon.
3. From the My Info Portal - Welcome screen, tap **Sign Up**, and then enter your account information. (For information on how to enter data, see [Entering Data and Editing Fields](#) on page 1-27.)
4. After you enter your account information, tap **Sign Up**.

If you tap **Main Menu**, you can now access the My Info Portal applications, and then view the information you want.

If your system administrator has set up My Info Portal to display on your idle screen, you will see information feeds from the idle screen.

Restarting Your Phone

Periodically, you may need to restart your phone so the phone can accept a new configuration.

Note

If your phone malfunctions, you may be able to restore normal operation without restarting it. Before you restart your phone, contact your system administrator. Call lists are automatically cleared when you restart the phone.

To restart the phone:

1. Tap  > **Settings** > **Basic** > **Restart Phone**.

The Restart Phone screen displays. The message “Are you sure?” displays.

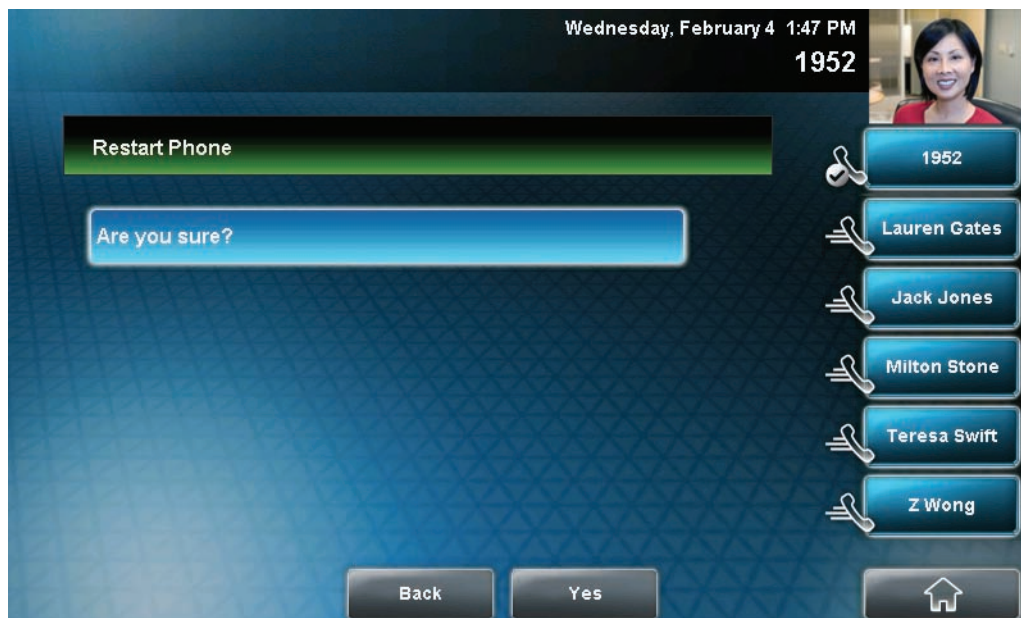

2. If you still want to restart the phone, tap the **Yes** soft key.

The restart process begins. The process ends when the idle screen displays.

Troubleshooting Your Phone

This chapter contains general troubleshooting information to help you solve any problems you might encounter when you use your Polycom VVX 1500 phone. The tables in this chapter list possible trouble symptoms, the likely causes of these problems, and the recommended corrective actions to take.

Problems are grouped as follows:

- [Power and Startup](#)
- [Controls](#)
- [Access to Screens and Systems](#)
- [Calling](#)
- [Displays](#)
- [Audio](#)

To obtain more detailed troubleshooting information, you can access certain menus on your phone that test your phone hardware. For more information, see [Testing Phone Hardware](#) on page 5-7.

If you require additional assistance, contact your system administrator.



Power and Startup

| Symptom | Problem | Corrective Action |
|-------------------------|-------------------------|-------------------------------------------------------------------------------------------------------------------------------------------------------------------------------------------------------------------------------------------------------------------------------------------------------------------------------------------------------------------------------------------------------------------------------------------------------------------------------------------------------------------------------------------------------------------------------|
| There are power issues. | The phone has no power. | Do one of the following steps: <ul style="list-style-type: none">• Verify that no lights appear on the phone when it is powered up.• Check if the phone is properly plugged into a functional AC outlet, if applicable.• Make sure that the phone isn't plugged into a plug controlled by a light switch that is off.• If the phone is plugged into a power strip, try plugging it directly into a wall outlet instead.• Try the phone in another room where the electricity is known to be working on a particular outlet. |



Controls

| Symptom | Problem | Corrective Action |
|----------------------------|--------------------------------------------|------------------------------------------------------------------------------------------------------------------------------------------------------------------------------------------------------------------------------------------------------------------------------------------------------------------------------------------------------------------------------------------------------------------------------------------------------------------------------------------------------------------------------------------------------------------------------------------------------------------------------------------------------------------------------------------------------------------------------------------------------------------------------------------------------------------------------------------------------------------------------------------------------------------------------------------------------------------------------------------------------------|
| The dialpad does not work. | The dialpad on the phone does not respond. | <p>Do one of the following steps:</p> <ul style="list-style-type: none"> • Check for a response from other feature keys or from the dialpad. • Place a call to the phone from a known working telephone. Check for display updates. • Check if the LAN port is active or inactive. Tap  > Status > Network > Ethernet. From the Ethernet page, scroll to LAN port and verify that it is active. • Check the termination at the switch or hub end of the network LAN cable. Ensure that the switch/hub port connected to the telephone is operational (if not accessible, contact your system administrator). • Before restarting your phone, contact your system administrator. Your system administrator may want to troubleshoot your phone in more detail before restarting the phone and losing current status information. |

Access to Screens and Systems

| Symptom | Problem | Corrective Action |
|----------------------------------------------------|------------------------------------------|-------------------------------------------------------------------------------------------------------------------------------------------------------------------------------------------------------------------------------------------------------------------------------------------------------------------------------------------------------------------------------------------------------------------------------------------------------------------------------------------------------------------------------------------------------------------------------------------------------------------------------------------------------------------------------------------------------------------------------------------------------------------------------------------------------------------------------------------------------|
| There is no response when you press a feature key. | The phone is not in an active state. | <p>Do one of the following steps:</p> <ul style="list-style-type: none"> Press the keys more slowly. Check with your system administrator to see if the key has been mapped to a different function or is disabled. Place a call to the phone to check that inbound call display and ringing is normal. If successful, try to press feature keys within the call to access the Menu, for example. To confirm that the line is active, tap  > Status > Lines > Line Information. From the Line Information page, verify that your phone line is registered. To attempt re-registration to the call server, reboot your phone. For more information, see your system administrator. |
| The display shows “Network Link is Down”. | The LAN cable is not properly connected. | <p>Do one of the following steps:</p> <ul style="list-style-type: none"> Check termination at the switch or hub (furthest end of the cable from the phone). Check that the switch or hub is operational (flashing link/status lights) or contact your system administrator. Check if the LAN port is active or inactive. Tap  > Status > Network > Ethernet. From the Ethernet screen, scroll to LAN port and verify that it is active. To attempt re-registration to the call server, reboot your phone. For more information, see your system administrator. |

Calling

| Symptom | Problem | Corrective Action |
|-------------------------------------------------------|----------------------------------------------------------------------------------------------------------------------------------------------------------------------------|----------------------------------------------------------------------------------------------------------------------------------------------------------------------------------------------------------------------------------------------------------------------------------------------------------------------------------------------------------------------------------------------|
| There is no dial tone. | Power is not correctly applied to the phone. | Do one of the following steps: <ul style="list-style-type: none"> • Check that the display is illuminated. • Make sure the LAN cable is inserted properly at the rear of the phone (try unplugging and re-inserting the cable). • If using Power over Ethernet (PoE), have your system administrator check that the switch is supplying power to the phone. |
| | Dial tone is not present on one of the audio paths. | Do one of the following steps: <ul style="list-style-type: none"> • Switch between Handset, Headset (if present) or Hands-Free Speakerphone to see if the dial tone is present on other paths. • If the dial tone exists on another path, connect a different handset or headset to isolate the problem. |
| The phone does not ring. | Ring volume is low. | While the phone is idle, adjust the ringing level by pressing  or  . |
| | Outbound or inbound calling is unsuccessful. | Do one of the following: <ul style="list-style-type: none"> • Place a call to the phone under investigation. Check that the display indicates incoming call information. • Lift the handset. Ensure the dial tone is present and place a call to another extension or number. Check that the display changes in response. |
| | The phone has a Silent ring tone. | Choose a ring tone other than Silent. See Updating the Ring Tone on page 2-20. |
| “Service Unavailable” appears on the graphic display. | The user tapped the New Call soft key, dialed a number with the handset on-hook, or attempted to make a call from the contact directory when the phone was not registered. | Check with your system administrator to see when your phone will be registered. |

Displays

| Symptom | Problem | Corrective Action |
|------------------------------------------------------------------------------------|---------------------------------------------------------------------------------------|----------------------------------------------------------------------------------------------------------------------------------------------------------------------------------------------------------------------------------------------------------------------------------------------------------------------------------------------------------------------------------------|
| There is no display. The display is incorrect. The display has bad contrast. | Power is not correctly applied to the phone. | Do one of the following: <ul style="list-style-type: none"> • Check that the display is illuminated. • Make sure the LAN cable is inserted properly at the rear of the phone (try unplugging and re-inserting the cable). • If using Power over Ethernet (PoE), have your system administrator check that the switch is supplying power to the phone. |
| | Outbound or inbound calling is unsuccessful. | Do one of the following: <ul style="list-style-type: none"> • Place a call to the phone under investigation. Check that the display indicates incoming call information. • Lift the handset. Ensure the dial tone is present and place a call to another extension or number. Check that the display changes in response. |
| The display flickers. | A certain type of older fluorescent lighting causes the display to appear to flicker. | Do one of the following: <ul style="list-style-type: none"> • Move the phone away from the lights. • Replace the lights. |

Audio

| Symptom | Problem | Corrective Action |
|-----------------------------------|----------------------------------|--------------------------------------------------------------------------------------------------------------------------------------------------------------------------------------------------------------------------------------------------------------------------------------------------------------------------------------------------------|
| There is no audio on the headset. | The connections are not correct. | Do one of the following steps: <ul style="list-style-type: none"> • Ensure the headset is plugged into the jack marked Headset on the back of the phone. • Ensure the headset amplifier (if present) is turned on and/or the volume is correctly adjusted. If the amplifier uses batteries, check that they are fully charged. |

Testing Phone Hardware

Your system administrator may ask you to access a diagnostics menu on your phone to test your phone hardware. From the diagnostics menu, you can test your phone's microphones, speaker, handset, third-party headset (if present), keypad mappings, and LCD display. See your system administrator for instructions on how to perform these tests.

To test your phone hardware:

>> Tap  > **Status > Diagnostics > Test Hardware > Audio Diagnostics, Keypad Diagnostics, or Display and Touch Screen Diagnostics.**

Safety Notices

Service Agreements

Please contact your Polycom Authorized Reseller for information about service agreements applicable to your product.

Governing Law

This Limited Warranty and Limitation of Liability shall be governed by the laws of the State of California, U.S.A., and by the laws of the United States, excluding their conflicts of laws principles. The United Nations Convention on Contracts for the International Sale of Goods is hereby excluded in its entirety from application to this Limited Warranty and Limitation of Liability.

All rights reserved under International and Pan-American Copyright Conventions. No part of the contents of this manual may be copied, reproduced, or transmitted in any form or by any means, or translated into another language or format, in whole or part, without written consent from Polycom, Inc. Do not remove (or allow anybody else to remove) any product identification, copyright or other notices.

Limitations of Liability

LIMITATION OF LIABILITY. TO THE FULL EXTENT ALLOWED BY LAW, POLYCOM EXCLUDES FOR ITSELF AND ITS SUPPLIERS ANY LIABILITY, WHETHER BASED IN CONTRACT OR TORT (INCLUDING NEGLIGENCE), FOR INCIDENTAL, CONSEQUENTIAL, INDIRECT, SPECIAL, OR PUNITIVE DAMAGES OF ANY KIND, OR FOR LOSS OF REVENUE OR PROFITS, LOSS OF BUSINESS, LOSS OF INFORMATION OR DATA, OR OTHER FINANCIAL LOSS ARISING OUT OF OR IN CONNECTION WITH THE SALE, INSTALLATION, MAINTENANCE, USE, PERFORMANCE, FAILURE, OR INTERRUPTION OF ITS PRODUCTS, EVEN IF POLYCOM OR ITS AUTHORIZED RESELLER HAS BEEN ADVISED OF THE POSSIBILITY OF SUCH DAMAGES, AND LIMITS ITS LIABILITY TO REPAIR, REPLACEMENT, OR REFUND OF THE PURCHASE PRICE PAID, AT POLYCOM'S OPTION. THIS DISCLAIMER OF LIABILITY FOR DAMAGES WILL NOT BE AFFECTED IF ANY REMEDY PROVIDED HEREIN SHALL FAIL OF ITS ESSENTIAL PURPOSE.

Polycom Limited Warranty and Limitation Liability

LIMITED WARRANTY. Polycom warrants to the end user ("Customer") that this product is expected to be free from defects in workmanship and materials, under normal use and service, for one year from the date of purchase from Polycom or its authorized reseller.

Polycom's sole obligation under this express warranty is at Polycom's option and expense, to repair the defective product or part, deliver to Customer an equivalent product or part to replace the defective item, or if neither of the two foregoing options are reasonably available, Polycom may, on its sole discretion, refund to Customer the purchase price paid for the defective product. All products that are replaced will become the property of Polycom. Replacement products or parts may be new or reconditioned.

Polycom is expected to warrant any replaced or repaired product or part for ninety (90) days from shipment, or the remainder of the initial warranty period, whichever is longer. Products returned to Polycom must be sent prepaid and packaged appropriately for safe shipment, and it is recommended that they be insured or sent by a method that provides for tracking of the package. Responsibility for loss or damage does not transfer to Polycom until the returned item is received by Polycom. The repaired or replaced item will be shipped to Customer, at Polycom's expense, not later than thirty (30) days after Polycom receives the defective product, and Polycom will retain risk of loss or damage until the item is delivered to Customer.

The product software comes with 90-day software warranty, providing for software updates (minor releases/bug fixes). To continue to receive support, purchasing a maintenance contract is the most economical solution.

Exclusions

Polycom will not be liable under this limited warranty if its testing and examination disclose that the alleged defect or malfunction in the product does not exist or results from:

- Failure to follow Polycom's installation, operation, or maintenance instructions.
- Unauthorized product modification or alteration.
- Unauthorized use of common carrier communication services accessed through the product.
- Abuse, misuse, negligent acts or omissions of Customer and persons under Customer's control; or
- Acts of third parties, acts of God, accident, fire, lightening, power surges or outages, or other hazards.

Warranty Exclusive

IF A POLYCOM PRODUCT DOES NOT OPERATE AS WARRANTED ABOVE, CUSTOMER'S SOLE REMEDY FOR BREACH OF THAT WARRANTY SHALL BE REPAIR, REPLACEMENT, OR REFUND OF THE PURCHASE PRICE PAID, AT POLYCOM'S OPTION. TO THE FULL EXTENT ALLOWED BY LAW, THE FOREGOING WARRANTIES AND REMEDIES ARE EXCLUSIVE AND ARE IN LIEU OF ALL OTHER WARRANTIES, TERMS, OR CONDITIONS, EXPRESS OR IMPLIED, EITHER IN FACT OR BY OPERATION OF LAW, STATUTORY OR OTHERWISE, INCLUDING WARRANTIES, TERMS, OR CONDITIONS OF MERCHANTABILITY, FITNESS FOR A PARTICULAR PURPOSE, SATISFACTORY QUALITY, CORRESPONDENCE WITH DESCRIPTION, AND NON-INFRINGEMENT, ALL OF WHICH ARE EXPRESSLY DISCLAIMED. POLYCOM NEITHER ASSUMES NOR AUTHORIZES ANY OTHER PERSON TO ASSUME FOR IT ANY OTHER LIABILITY IN CONNECTION WITH THE SALE, INSTALLATION, MAINTENANCE OR USE OF ITS PRODUCTS.

Safety and Compliance

Part 15 FCC Rules

This device is compliant with Part 15 of the FCC Rules. Operation is subject to the following two conditions:

1. This device may not cause harmful interference, and
2. This device must accept any interferences received, including interference that may cause undesired operation.

Class B Digital Device or Peripheral

Note: This equipment is tested and complies with the limits for a Class B digital device, pursuant to Part 15 of the FCC Rules. These limits are designed to provide reasonable protection against harmful interference in a residential installation. This equipment generates, uses, and can radiate radio frequency energy and, if not installed and used in accordance with the instructions, may cause harmful interference to radio communications. However, there is no guarantee that interference will not occur in a particular installation. If this equipment does cause harmful interference to radio or television reception, which can be determined by turning the equipment off and on, the user is encouraged to try to correct the interference by one or more of the following measures:

1. Reorient or relocate the receiving antenna.
2. Increase the separation between the equipment and receiver.
3. Connect the equipment into an outlet on a circuit different from that to which the receiver is connected.
4. Consult the dealer or an experienced radio/TV technician for help.

Modifications

In accordance with Part 15 of the FCC Rules, the user is cautioned that any changes or modifications not expressly approved by Polycom, Inc. could void the user's authority to operate the equipment. This equipment may not be used on a coin service or party line.

Installation Instructions

Installation must be performed in accordance with all relevant national wiring rules.

L'Installation doit être exécutée conformément à tous les règlements nationaux applicable au filage électrique.

When using Power over Ethernet (PoE), the equipment is to be connected only to PoE networks without connections to the outside plant.

Plugs Acts as Disconnect Device

The socket outlet to which this apparatus is connected must be installed near the equipment and must always be readily accessible.

La prise électrique à laquelle l'appareil est branché doit être installée près de l'équipement et doit toujours être facilement accessible.

Industry Canada (IC)

This Class [B] digital apparatus complies with Canadian ICES-003.

Cet appareil numérique de la classe [B] est conforme à la norme NMB-003 du Canada.

CE and VCCI Mark

This Polycom VVX 1500 phone is marked with the CE mark. This mark indicates compliance with EC Directives 2006/95/EC and 2004/108/EC. A full copy of the Declaration of Conformity can be obtained from Polycom Ltd., 270 Bath Road, Slough, Berkshire, SL1 4DX, UK.

この装置は、情報処理装置等電波障害自主規制協議会（VCCI）の基準に基づくクラスB情報技術装置です。この装置は、家庭環境で使用することを目的としていますが、この装置がラジオやテレビジョン受信機に近接して使用されると、受信障害を引き起こすことがあります。

取扱説明書に従って正しい取り扱いをして下さい。

Safety and Compliance (continued)

WARNING Electrical Safety

To avoid electric shock, do not connect safety extra low voltage (SELV) circuits to teleconference station network (TNV) circuits. LAN ports contain SELV circuit, and WAN ports contain TNV circuits. Some LAN and WAN ports both use RJ-45 connectors. Use caution when connecting cables.

This product is rated 48Vdc, 0.375A. When used with the optional external power supply, the power supply shall be a Listed power supply with a LPS output, rated 48V, min. 0.375A.

Russian Compliance

Ministry of Information Technologies & Communication of the Russian Federation - Declaration of Conformity DoC # Д-СПД-2626. Expiry 17/11/2011.

New Zealand Telepermit

PTC General Warning

The grant of a Telepermit for any item of terminal equipment indicates only that Telecom has accepted that the item complies with minimum conditions for connection to its network. It indicates no endorsement of the product by Telecom, nor does it provide any sort of warranty. Above all, it provides no assurance that any item will work correctly in all respects with another item of Telepermitted equipment of a different make or model, nor does it imply that any product is compatible with all of Telecom's network services.

The Use of IP Networks through the PSTN

Internet Protocol (IP) by its nature introduces delay into speech signals as each data packet is formulated and addressed. Telecom Access Standards recommends that suppliers, designers and installers using this technology for calls to or from the PSTN refer to ITU E Model requirements in the design of their networks. The overall aim is to minimise delay, distortion and other transmission impairments, particularly for those calls involving cellular and international networks, which already suffer extensive delay.

Echo cancellation

Echo cancellers are not normally required in the Telecom PSTN because geographic delays are acceptable where CPE return loss is maintained within Telepermit limits. However, those private networks making use of Voice over IP technology are required to provide echo cancellation for all voice calls. The combined effect of audio / VoIP conversion delay and IP routing delay can cause the echo cancellation time of 64 mS to be required.

Connection of this Polycom VVX 1500 VoIP Video Telephone to the Telecom network

All samples of this Polycom VVX 1500 VoIP Video Telephone connected to the Telecom network must be modified as described in KTL Test Report number 8A1710ANZ1 failure to do so will lead to the cancellation of this Telepermit.

Index

Numerics

3.5mm connector, location of 1-10

A

answering calls 3-12

App key, about 1-17

arrow keys, about 1-16

attended transfer 3-25

Auto Divert setting 2-50, 2-64

Auto Reject setting 2-50, 2-62

B

background picture, updating 2-8, 2-15, 2-16

backlight intensity 2-17

BLF feature 4-16

blind transfer 3-25

Block Buddy setting 2-50, 4-12

Blocked List, accessing 4-11

buddies, managing 4-8

buddies, monitoring 4-13

buddy lists, about 4-6

Busy Lamp Field feature 4-16

C

call lists, clearing 2-43

call lists, using 2-41

calls

answering 3-12

diverting 2-63

ending 3-15

forwarding 3-28

handling multiple 3-17

holding 3-16

ignoring 3-12

obtaining information about 2-44

placing 3-6

placing using speed dial 3-10

recording 4-17

rejecting 2-61, 3-12

transferring 2-63, 3-25

camera

adjusting 1-13

barrel, adjusting 1-13

settings, updating 2-32

characters, entering 1-28, 1-30

cleaning the touch screen 1-31

clock order, changing 2-6

computer, connecting to phone 1-11

Conf key, about 1-17

conference call participants, managing 3-23

conference calls

about 3-18

best practices for 1-31

choosing far-site video for 3-22

ending 3-22

holding and resuming 3-21

holding participants 3-24

managing 3-22, 3-23

muting participants 3-24

recording 4-21

removing participants 3-24

setting up 3-19, 3-20, 3-21

splitting into two calls on hold 3-22

tips for 1-31

consultative transfer 3-25

Contact Directory

about 2-44

adding contacts to 2-46, 2-51, 2-52

calling from 2-59

deleting contacts from 2-58

searching for contacts in 2-54

updating contacts in 2-56

viewing contacts in 2-44

contacts

adding to local directory 2-46, 2-51, 2-52

calling 2-59, 2-60

deleting 2-58

saving from Corporate Directory 2-53

searching for 2-54, 2-55

setting unique ring tones for 2-21

updating 2-56

viewing 2-44, 2-45

Corporate Directory

- about 2-44
- calling from 2-60
- and Retain Search feature 2-55
- saving contacts to local directory 2-53
- searching for contacts in 2-55
- viewing contacts in 2-45

D

- data, entering 1-27
- date and time display, changing 2-3
- Delete key, about 1-16
- deleting text 1-29, 1-30
- dialpad keys, about 1-18
- Dir key, about 1-18
- directory. *See* Contact Directory or Corporate Directory
- divert contact setting 2-49, 2-64
- diverting calls 2-63
- DND key, about 1-17
- Do Not Disturb, enabling 3-33

E

- electronic hookswitch 2-8
- ending calls 3-15

F

- Far Mute soft key 3-23
- far-site video
 - choosing in conference calls 3-22
 - displaying on full screen 2-27, 3-5
 - swapping with near site 3-6
- ferrite clamps, attaching 1-5
- fields
 - enabling and disabling 1-26
 - selecting 1-25
 - updating 1-27
- flash drive, connecting to phone 1-9
- flash drives, supported 1-9
- flicker avoidance, adjusting 2-34
- forwarding calls 3-28

H

- handset
 - answering calls with 3-13
 - connecting 1-8
 - placing calls with 3-8
- handsfree mode disabled, about 3-8, 3-13
- headphones, connecting 1-10

headset

- answering calls with 3-14
- connecting to phone 1-8
 - and electronic hookswitch 2-8
 - memory mode, enabling 2-7
 - placing calls with 3-9
- Headset key, about 1-17
- headsets, supported 1-8
- hidden soft keys, viewing 1-26
- Hold key, about 1-17
- holding calls 3-16
- holding conference call participants 3-24

I

- icons, list of 1-22
- ignoring calls 3-12
- inactive call group, about 1-20
- instant messaging, using 4-1
- IP addresses, entering 1-27

K

- keyboard, virtual, using 1-27
- keys, about 1-16

L

- Label field 2-49
- language support 2-3
- language, changing 2-3
- languages, special 1-29
- Launch Pad, using 4-30
- letters, entering 1-28, 1-30
- Line Key icons 2-65
- Line Key status indicators 1-20, 4-16
- Line Keys, about 1-21
- lines, multiple 2-64
- local camera view mode 2-32
- local directory. *See* Contact Directory
- lowercase characters, entering 1-28, 1-30

M

- maximum backlight intensity 2-17
- Menu key, about 1-18
- microphone, muting 2-40
- Microsoft Office Live Communications Server 2005 4-6, 4-14
- missed calls list 2-41
- motion detection, about 2-39
- Msg key, about 1-18

- multiple Line Keys per line, about 2-67
- Mute key, about 1-17
- muting conference call participants 3-23
- muting the microphone 2-40
- My Info Portal, about 4-30
- My Info Portal, enabling 4-32

N

- navigating menus, lists and fields 1-24
- navigational keys, about 1-16
- near-site video
 - automatically enabling 2-25
 - disabling 2-23
 - displaying on full screen 3-5
 - starting 3-5
 - stopping 2-23, 3-5
 - swapping with far site 3-6
- network source, connecting to phone 1-5
- numbers, entering 1-29, 1-30
- numbers, redialing 3-15

O

- Off Hours Mode, about 2-35
- off hours sensitivity, setting 2-40
- office hours sensitivity, setting 2-40
- office hours, updating 2-36
- optional components, connecting to phone 1-8

P

- parts list 1-2
- picture frame feature, using 2-14, 4-30
- pictures on USB flash drive, displaying 2-14
- PIP
 - about 3-3
 - disabling 2-32
 - and PIP mode 2-32
 - and side-by-side mode 2-32
 - updating display of 2-29
- placed calls list 2-41
- placing calls 3-6
- playing back calls
 - answering calls 4-28
 - browsing files 4-25
 - how to start 4-27
 - how to stop 4-28
 - introduction 4-23
 - pausing 4-28
 - resuming 4-28
 - when you can 4-24
 - where you can 4-24

- PoE, using 1-6
- power adapter, connecting to phone 1-7
- Power over Ethernet, using 1-6
- power saving feature, using 2-34
- power source, connecting to phone 1-5
- presence settings, updating 4-6
- presence, monitoring 4-6
- privacy shutter, opening 1-13

R

- received calls list 2-41
- recording calls 4-17
 - file format 4-19
 - how to start 4-20
 - how to stop 4-21
 - introduction 4-17
 - pausing 4-22
 - resuming 4-22
- Redial key, about 1-17
- redialing numbers 3-15
- registering the phone 1-14
- rejecting calls 2-61, 3-12
- removing conference call participants 3-24
- restarting the phone 4-33
- restarting the phone, and call lists 2-43
- Retain Search feature 2-55
- ring tone, updating for contacts 2-21
- ring tone, updating for phone 2-20
- ringer volume, adjusting 2-41

S

- screen saver, setting up 2-9
- screen saver, stopping or disabling 2-13
- screen, adjusting 1-12
- screen, cleaning 1-31
- Select key, about 1-16
- Select Video soft key 3-23
- shared lines, about 2-68
- shared lines, and rejecting calls 2-61
- silent ring, and answering calls 3-12
- soft keys, viewing hidden 1-26
- speaker volume, adjusting 2-41
- speakerphone disabled, about 3-8, 3-13
- Speakerphone key, about 1-17
- speakerphone, placing calls with 3-8
- special characters, entering 1-29, 1-30
- special languages, entering text in 1-29

- speed dial
 - keys, and buddies 4-13
 - keys, assigning 3-38
 - keys, updating 3-40
 - status indicators 4-13
 - using 3-10
- stand, adjusting 1-3
- status
 - indicators, on Line Keys 1-20, 4-16
 - indicators, on Speed Dial Keys 4-13
 - updating My Status 4-6
- swapping video 3-6

T

- target frame rate, updating 2-33
- text messaging, using 4-1
- text, deleting 1-29, 1-30
- time and date
 - display, changing 2-3
 - display, disabling 2-6
 - order, changing 2-6
- timeouts, updating 2-37
- touch screen, cleaning 1-31
- Transfer key, about 1-17
- transferring calls 3-25
- troubleshooting
 - audio problems 5-6
 - calling problems 5-5
 - controls problems 5-3
 - diagnostics 5-7
 - display problems 5-6
 - power and startup problems 5-2
 - screen and system problems 5-4

U

- uppercase characters, entering 1-28, 1-30
- URLs, entering 1-27
- USB flash drive, connecting to phone 1-9
- USB flash drives, supported 1-9
- user detection settings, updating 2-39
- user detection, about 2-35

V

- video
 - adjusting proportions of 2-28
 - automatically enabling near site 2-25
 - call settings, updating 2-25
 - disabling and stopping near site 2-23
 - disabling, for all calls 2-24
 - displaying far site on full screen 2-27
 - displaying on full screen 3-5
 - handling during conference calls 3-3
 - mail, accessing 3-42
 - screen mode, updating 2-28
 - selecting active participant 3-23
 - settings, updating 2-24
 - starting and stopping near site 3-5
- Video key, about 1-17
- Video soft keys, using 3-5
- virtual keyboard, using 1-27
- voice and video mail, accessing 3-42
- voice mail, and rejected calls 2-61
- volume
 - keys, about 1-16
 - of ringer, adjusting 2-41
 - of speaker, adjusting 2-41

W

- Watch Buddy setting 2-50, 4-10
- Watcher List, accessing 4-11

End-User License Agreement for Polycom[®] Software

This End-User License Agreement (“Agreement”) is a legal agreement between you (either an individual or a single entity) and Polycom, B.V for the Polycom Software Product licensed by Polycom B.V in Europe, the Middle East, Africa, and Asia Pacific or Polycom, Inc., for the Polycom Software Product licensed by Polycom, Inc. in the rest of the world (collectively, “Polycom”). The Software Product includes the computer software included herewith and may include associated media, printed materials and online or electronic documentation (“Software Product”). By clicking ‘I agree’ or by installing, copying, or otherwise using the Software Product, you agree to be bound by the terms of this Agreement. If you do not agree to the terms of this Agreement, do not install or use the Software Product, and return it to your place of purchase for a full refund.

The Software Product is protected by copyright laws and international copyright treaties, as well as other intellectual property laws and treaties. The Software Product is licensed (not sold) to you, and its use is subject to the terms of this Agreement.

1. GRANT OF LICENSE.

Subject to the terms of this Agreement, Polycom grants to you a nonexclusive license to install and use the Software Product included with the Polycom product that incorporates or uses the Software Product (the “Product”). You may use the Software Product only in connection with the use of the Product. You are not permitted to lease, rent, distribute or sublicense the Software Product or to use the Software Product in a time-sharing arrangement or in any other unauthorized manner. Further, no license is granted to you in the human readable code of the Software Product (source code). Except as provided below, this License Agreement does not grant you any rights to patents, copyrights, trade secrets, trademarks, or any other rights in respect to the Software Product.

2. DESCRIPTION OF OTHER RIGHTS AND LIMITATIONS.

2.1 Limitations on Reverse Engineering, Decompilation, and Disassembly. You may not reverse engineer, decompile, or disassemble the Software Product, except and only to the extent that such activity is expressly permitted by applicable law notwithstanding this limitation. The Software Product is licensed as a single product. Its component parts may not be separated for use on more than one Product.

2.2 Backup. Except as expressly provided for under this Agreement, you may not copy the Software Product, except, however, you may keep one copy of the Software Product and, if applicable, one copy of any previous version for back-up purposes, only to be used in the event of failure of the original. All copies of the Software Product must be marked with the proprietary notices provided on the original Software Product. You may not reproduce the supporting documentation accompanying the Software Product.

2.3 Modifications. You may not modify, translate, or create derivative works of the Software Product.

2.4 Proprietary Notices. You may not remove or obscure any proprietary notices on or in the Software Product or the supporting documentation.

2.5 Software Transfer. You may permanently transfer all of your rights under this Agreement provided you retain no copies, you transfer all of the Software Product (including all component parts, the media, any printed materials, any upgrades, this Agreement, and, if applicable, the Certificate of Authenticity), and any recipient agrees to the terms of this Agreement. If the Software Product is an upgrade, any transfer must include all prior versions of the Software Product. However, if the Software Product is marked “Not for Resale” or “NFR,” you may not resell it or otherwise transfer it for value.

2.6 Copyright. All title and copyrights in and to the Software Product (including, but not limited to, any images, photographs, animations, video, audio, music, text, and “applets” incorporated into the Software Product), the accompanying printed materials, and any copies of the Software Product are owned by Polycom or its suppliers. The Software Product is protected by copyright laws and international treaty provisions. Title, ownership rights, and intellectual property rights in the Software Product shall remain In Polycom or its suppliers. Title and related rights in the content accessed through the Software Product is the property of such content owner and may be protected by applicable law. This Agreement gives you no rights in such content.

2.7 Confidentiality. The Software Product contains valuable proprietary information and trade secrets of Polycom and its suppliers and you shall protect the confidentiality of, and avoid disclosure and unauthorized use of, the Software Product.

2.8 Dual-Media Software. You may receive the Software Product in more than one medium. Regardless of the type or size of medium you receive, you may use only one medium that is appropriate for your single Product. You may not use or install the other medium on another Product.

2.9 Reservation. Polycom reserves all rights in the Software Product not expressly granted to you in this Agreement.

3. SUPPORT SERVICES.

Polycom may provide you with support services related to the Software Product (“Support Services”). Use of Support Services is governed by the Polycom policies and programs described in the Polycom-provided materials. Any supplemental software code provided to you as part of the Support Services is considered part of the Software Product and is subject to the terms and conditions of this Agreement. With respect to technical information you provide to Polycom as part of the Support Services, Polycom may use such information for its business purposes, including for product support and development. Polycom will not utilize such technical information in a form that personally identifies you.

4. TERMINATION.

Without prejudice to any other rights, Polycom may terminate this Agreement if you fail to comply with any of the terms and conditions of this Agreement. In such event, you must destroy all copies of the Software Product and all of its component parts. You may terminate this Agreement at any time by destroying the Software Product and all of its component parts.

5. UPGRADES.

If the Software Product is labeled as an upgrade, you must be properly licensed to use the software identified by Polycom as being eligible for the upgrade in order to use the Software Product. A Software Product labeled as an upgrade replaces and/or supplements the software that formed the basis for your eligibility for the upgrade. You may use the resulting upgraded Software Product only in accordance with the terms of this Agreement. If the Software Product is an upgrade of a component of package of software programs that you licensed as a single product, the Software Product may be used and transferred only as part of that single Software Product package and may not be separated for use on more than one Product.

6. WARRANTY AND WARRANTY EXCLUSIONS.

6.1 Limited Warranty. Polycom warrants that (a) the Software Product will perform substantially in accordance with the accompanying documentation for a period of ninety (90) from the date of receipt by you, and (b) any Support Services provided by Polycom shall be substantially as described in applicable written materials provided to you by Polycom, and Polycom support engineers will make commercially reasonable efforts to solve any problem issues. Polycom does not warrant that your use of the Software Product will be uninterrupted or error free, or that all defects in the Software Product will be corrected. Polycom’s sole obligation under this express warranty shall be, at Polycom’s option and expense, to

refund the purchase price paid by you for any defective software product which is returned to Polycom with a copy of your receipt, or to replace any defective media with software which substantially conforms to applicable Polycom published specifications. Any replacement Software Product will be warranted for the remainder of the original warranty period or thirty (30) days, whichever is longer.

6.2 Warranties Exclusive. If this Software Product does not operate as warranted above, your sole remedy for breach of that warranty shall be repair, replacement, or refund of the purchase price paid, at Polycom's option. TO THE FULL EXTENT ALLOWED BY LAW, THE FOREGOING WARRANTIES AND REMEDIES ARE EXCLUSIVE AND ARE IN LIEU OF ALL OTHER WARRANTIES, TERMS OR CONDITIONS, EXPRESS OR IMPLIED, EITHER IN FACT OR BY OPERATION OF LAW, STATUTORY OR OTHERWISE, INCLUDING WARRANTIES, TERMS OR CONDITIONS OF MERCHANTABILITY, FITNESS FOR A PARTICULAR PURPOSE, SATISFACTORY QUALITY, CORRESPONDENCE WITH DESCRIPTION, AND NON-INFRINGEMENT, ALL OF WHICH ARE EXPRESSLY DISCLAIMED. POLYCOM NEITHER ASSUMES NOR AUTHORIZES ANY OTHER PERSON TO ASSUME FOR IT ANY OTHER LIABILITY IN CONNECTION WITH THE SALE, INSTALLATION, MAINTENANCE, OR USE OF THIS SOFTWARE PRODUCT.

POLYCOM SHALL NOT BE LIABLE UNDER THIS WARRANTY IF ITS TESTING AND EXAMINATION DISCLOSE THAT THE ALLEGED DEFECT OR MALFUNCTION IN THE SOFTWARE PRODUCT DOES NOT EXIST OR WAS CAUSED BY YOUR OR ANY THIRD PERSON'S MISUSE, NEGLIGENCE, IMPROPER INSTALLATION OR TESTING, UNAUTHORIZED ATTEMPTS TO MODIFY THE PRODUCT, OR ANY OTHER CAUSE BEYOND THE RANGE OF THE INTENDED USE, OR BY ACCIDENT, FIRE, LIGHTNING, POWER CUTS OR OUTAGES, OTHER HAZARDS, OR ACTS OF GOD.

7. LIMITATION OF LIABILITY.

TO THE MAXIMUM EXTENT PERMITTED BY APPLICABLE LAW, IN NO EVENT SHALL POLYCOM OR ITS SUPPLIERS BE LIABLE FOR ANY SPECIAL, INCIDENTAL, INDIRECT, OR CONSEQUENTIAL DAMAGES WHATSOEVER (INCLUDING, WITHOUT LIMITATION, DAMAGES FOR LOSS OF BUSINESS PROFITS, BUSINESS INTERRUPTION, LOSS OF BUSINESS INFORMATION, OR ANY OTHER PECUNIARY LOSS) ARISING OUT OF THE USE OR INABILITY TO USE THE SOFTWARE PRODUCT OR THE PROVISION OF OR FAILURE TO PROVIDE SUPPORT SERVICES, EVEN IF POLYCOM HAS BEEN ADVISED OF THE POSSIBILITY OF SUCH DAMAGES. IN ANY CASE, POLYCOM'S ENTIRE LIABILITY SHALL BE LIMITED TO THE GREATER OF THE AMOUNT ACTUALLY PAID BY YOU FOR THE SOFTWARE PRODUCT OR U.S. \$5.00; PROVIDED, HOWEVER, IF YOU HAVE ENTERED INTO A POLYCOM SUPPORT SERVICES AGREEMENT, POLYCOM'S ENTIRE LIABILITY REGARDING SUPPORT SERVICES SHALL BE GOVERNED BY THE TERMS OF THAT AGREEMENT.

8. DISCLAIMER.

Some countries, states, or provinces do not allow the exclusion or limitation of implied warranties or the limitation of incidental or consequential damages for certain products supplied to consumers, or the limitation of liability for personal injury, so the above limitations and exclusions may be limited in their application to you. When the implied warranties are not allowed to be excluded in their entirety, they will be limited to the duration of the applicable written warranty. This warranty gives you specific legal rights which may vary depending on local law.

9. EXPORT CONTROLS.

The Software Product may not be downloaded or otherwise exported or re-exported (i) into (or to a national or resident of) Cuba, North Korea, Iran, Syria, Sudan, or any other country to which the U.S. has embargoed goods; or (ii) to anyone on the U.S. Treasury Department's List of Specially Designated Nationals or the U.S. Commerce Department's Table of Denial Orders. By downloading or using this Software Product, you are agreeing to the foregoing and you are representing and warranting that you are

not located in, under the control of, or a national or resident of any such country or on any such list. If you obtained this Software Product outside of the United States, you are also agreeing that you will not export or re-export it in violation of the laws of the country in which it was obtained.

10. MISCELLANEOUS.

10.1 Governing Law. This Agreement shall be governed by the laws of the State of California, as such laws are applied to agreements entered into and to be performed entirely within California between California residents, and by the laws of the United States. The United Nations Convention on Contracts for the International Sale of Goods (1980) is hereby excluded in its entirety from application to this Agreement.

10.2 General. This Agreement represents the complete agreement concerning this license and may amended only by a writing executed by both parties. If any provision of this Agreement is held to be unenforceable, such provision shall be reformed only to the extent necessary to make it enforceable.

10.3 Contact. If you have any questions concerning this Agreement, or if you desire to contact Polycom for any reason, please contact the Polycom office serving your country.

10.4 U.S. Government Restricted Rights. The software and documentation provided by Polycom pursuant to this Agreement are "Commercial Items," as the term is defined at 48 C.F.R. §2.101, consisting of "Commercial Computer Software" and "Commercial Computer Software Documentation," as such terms are used in 48 C.F.R. §12.212 or 48 C.F.R. §227.7202, as applicable. Consistent with 48 C.F.R. §12.212 or 48 C.F.R. §§227.7202-1 through 227.7202-4, as applicable, the Commercial Computer Software and Commercial Computer Software Documentation are licensed to United States Government end users (1) only as Commercial Items and (2) with only those rights as are granted to all other users pursuant to the terms of this Agreement.