

MV-372

VoIP GSM Gateway

User Manual



PORTech Communications Inc.

【Content】

1.INTRODUCTION	1
2.FUNCTION DESCRIPTION	1
3.PARTS LIST	1
4.DIMENSION.....	2
5.CHART OF THE DEVICE	3
6.CABLING.....	4
7.WEB PAGE SETTING	5
8.SYSTEM INFORMATION.....	6
9. ROUTE	6
10.MOBILE.....	12
11.NETWORK.....	19
12.SIP SETTING	23
13. NAT TRANS	32
14.SYSTEM AUTH.	33
15.SAVE CHANGE	34
16.UPDATE.....	35
17.REBOOT	37
18. IP SETTING	38
19.SPECIFICATION	40
20. APPENDIX: SETUP MV-370 WITH ASTERISK.....	41
21.HOW TO SETUP ASTERISK TO RECEIVE CALLER ID FROM MV-372.....	47
22. SIMPLE STEPS.....	57

1.Introduction

MV-372 is a 2 channels VoIP GSM Gateway for call termination (VoIP to GSM) and origination (GSM to VoIP). It is SIP based and compatible with Asterisk. It can enable to make 2 calls simultaneously from IP phones to GSM networks and GSM network to IP phone.

2.Function description

2.1 VoIP(SIP) 、 GSM(MV-372) conversion.

2.2 50 sets of LAN->MOBILE routes setting , 50 sets of MOBILE->LAN routes setting.

2.3 Voice response for setting and status (dial in from mobile).

2.4 Series connections to save bills.

2.5 Standard SIP(RFC2543,RFC3261) protocol ,
Communicates with other gateway or PC.

3.Parts list

Please check the parts for any missing parts. If do, please contact our agents :

3.1 「 MV-372 」 main body

3.2 Power adaptor AC-DC (110V AC – 12V DC) or (220V AC – 12V DC)

3.3 Network cable

3.4 Antenna

3.5 User Manual



(1)



(2)



(3)



(4)

4.Dimension

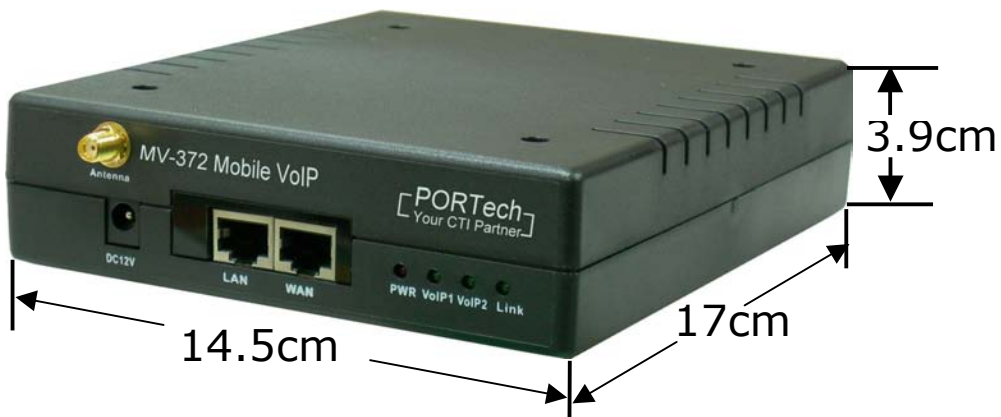

5. Chart of the device



5.1 Antenna : Antenna connector.

5.2 DC 12V : Power input.

5.3 LAN : LAN port. It also can be DHCP Server.

5.4 WAN: RJ-45 internet connector , standard RJ-45 socket , connect to HUB.

5.5 PWR (Power LED) : Light up when power is normal.

5.6 VoIP1 : an indicator light of VoIP1

5.7 VoIP2 : an indicator light of VoIP2

5.8 LINK Indicator : Light up when network is connected.

6.CABLING

6.1 Connect the internet cable from HUB to the 'WAN' connector of the MV-372.

*If you need to stack up more MV-372, you can stack up as follows.

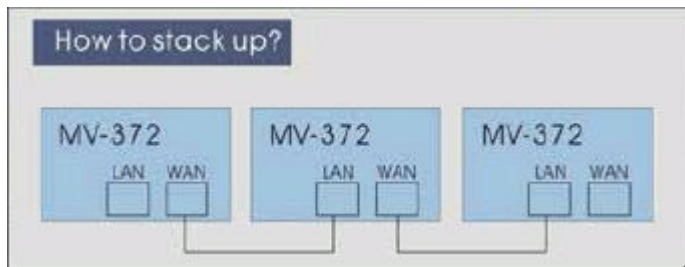

6.2 Connect the antenna and put it in proper position to get the best signal reception.

6.3 Insert the SIM card from back of the main body. (take the slide off first).

6.4 Click reset button 3 sec. MV-372 will restore default IP. Other setting as usual.

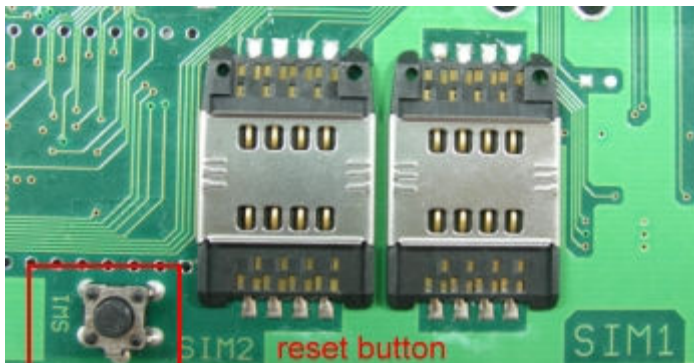

6.5 Connect the power adaptor. The 'POWER' LED should be light up.

7. Web Page Setting

When the IP setting is done, the operator may setup all the rest parameters via web page. Browse the IP address from Internet Explorer (e.g. <http://192.168.0.100>) . The following page shows up :

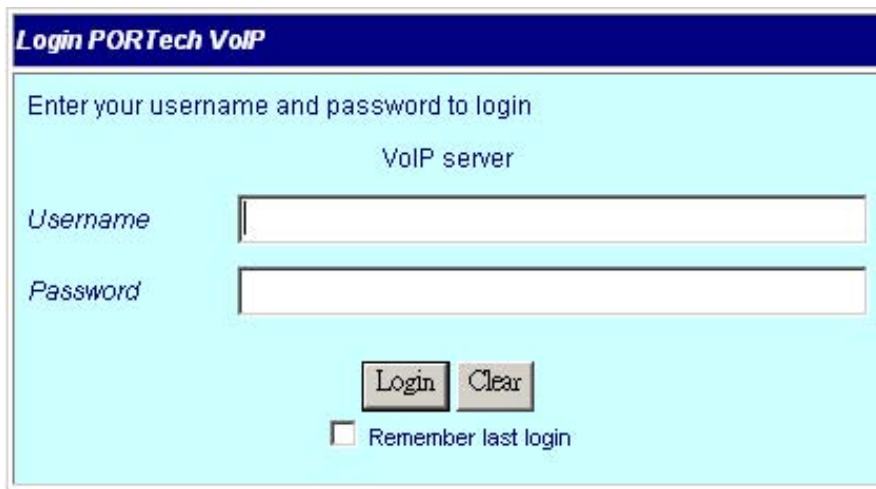

Login PORTech VoIP

Enter your username and password to login

VoIP server

Username

Password

Remember last login

Enter the username and password for authentication. (default username=voip, password=1234). The page follows when the username and password are correct.

8. System Information.

- 8.1 When you login the web page, you can see the demo system current system information like firmware version, company... etc in this page.
- 8.2 Also you can see the function lists in the left side. You can use mouse to click the function you want to set up.

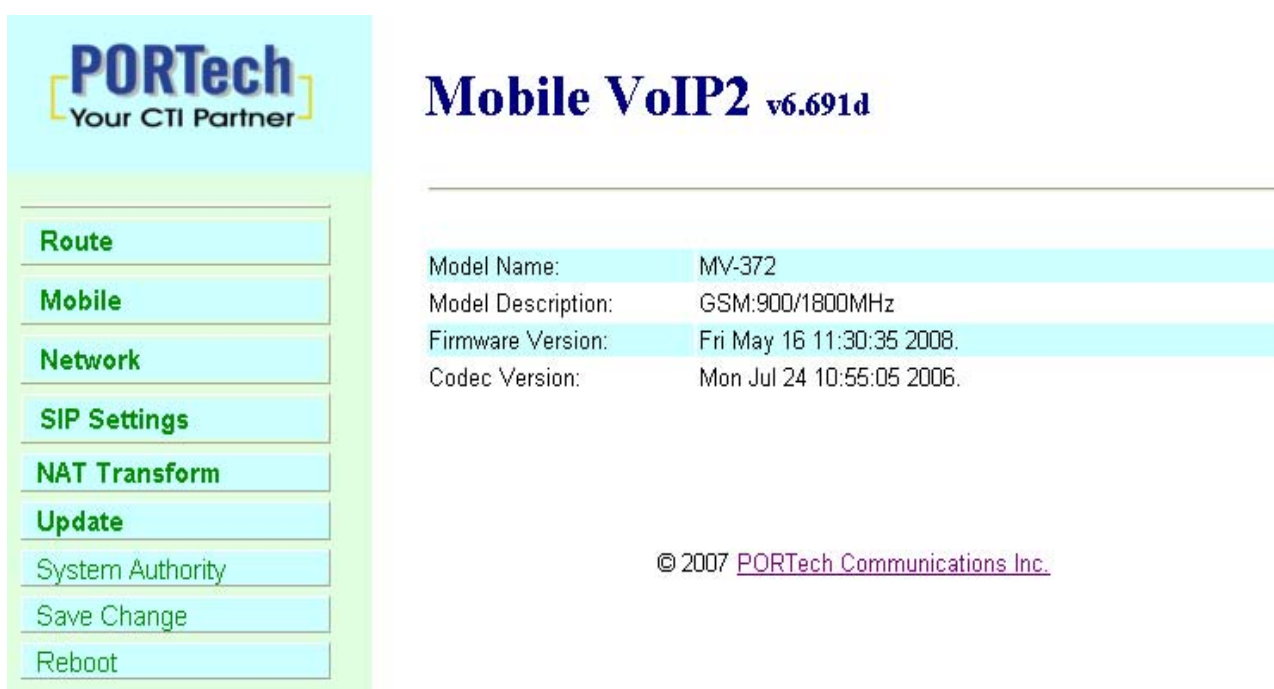

PORTech
Your CTI Partner

Mobile VoIP2 v6.691d

Model Name:	MV-372
Model Description:	GSM:900/1800MHz
Firmware Version:	Fri May 16 11:30:35 2008.
Codec Version:	Mon Jul 24 10:55:05 2006.

© 2007 [PORTech Communications Inc.](#)

9. Route

Important:

The route table -50 sets can share by two channels

The setting, please refer 10.2 Mobile setting

ex: Mobile 1 use the route table for item 0-24,

Mobile 2 use the route table for item 25-49

9.1 Mobile TO LAN Settings

The operator may assign 50 sets of routing rule to transfer the call incoming from MOBILE to LAN.

The screenshot shows the PORTech web interface. On the left is a navigation menu with the following items: Route, Mobile To Lan Settings (highlighted with a red box), Mobile To Lan Speed Dial, Lan To Mobile Settings, Mobile, Network, SIP Settings, NAT Transform, Update, System Authority, Save Change, and Reboot. The main content area is titled "Mobile To LAN Table". It includes a "Page: 1" dropdown menu. Below this is a table with the following structure:

Item	CID	URL	Select
0	*	*	<input type="checkbox"/>
1			<input type="checkbox"/>
2			<input type="checkbox"/>
3			<input type="checkbox"/>
4			<input type="checkbox"/>
5			<input type="checkbox"/>
6			<input type="checkbox"/>
7			<input type="checkbox"/>
8			<input type="checkbox"/>
9			<input type="checkbox"/>

Below the table are three buttons: "Delete Selected", "Delete All", and "reset".

Under the "Add New" section, there are three input fields:

- Position: (0~49)
- CID: Ex:0911111111, 0911*, *
- URL: Ex:192.168.0.1, *:2St

At the bottom of the "Add New" section are two buttons: "Add" and "reset".

The MV-372 will transfer to the URL according to the caller ID of the Mobile.

*CID :

- (1) may enter the whole number, e.g. 0911111111
- (2) only part of the number (prefix) e.g. 0911* means any number starting with 0911 will be accepted
- (3) * means all numbers can be accepted

(4) N means the calls without the CID

Please note the priority of the rules. The item which has more digits will have higher priority. If the digits are the same, then former one gets the higher priority.

*URL : The IP address to transfer this call

(1) may enter the whole IP address, e.g. 192.168.0.101 or proxy extension or phone number.

(2) If this field is blank or simply 'N', it means refuse to transfer.

(3) If an '*' entered, it means 2-stages-dialing. The call will be answered and prompt dial tone again to receive the IP address/sip extension or **any phone number** as the destination. The caller may enter the IP such as 192*168*0*101#.

*If the device have register proxy server/Asterisk ,you can enter any destination phone number. Please note the proxy server/Asterisk need to set the route of destination phone number.

Example:

(1) Mobile to Lan: 0932*,0911123456

MV-372 have register proxy server/Asterisk

The proxy server/Asterisk have the route "09"

When the caller's prefix number is 0932,MV-372 will connect 0911123456 automaticly

(2) Mobile to Lan: *,*

Any caller call the MV-372's sim,MV-372 will prompt dial tone.Caller can enter IP or sip extension or phone number.

*sip extension or phone number both need to register SIP Proxy Server or Asterisk.

*Phone number, SIP Proxy Server or Asterisk need to set the route of this phone number.

9.2 Mobile to LAN Speed Dial Settings

When you set Mobile to LAN Speed Dial Settings and Mobile to LAN at the same time, MV-372 will give priority to Mobile to LAN Speed Dial Settings.

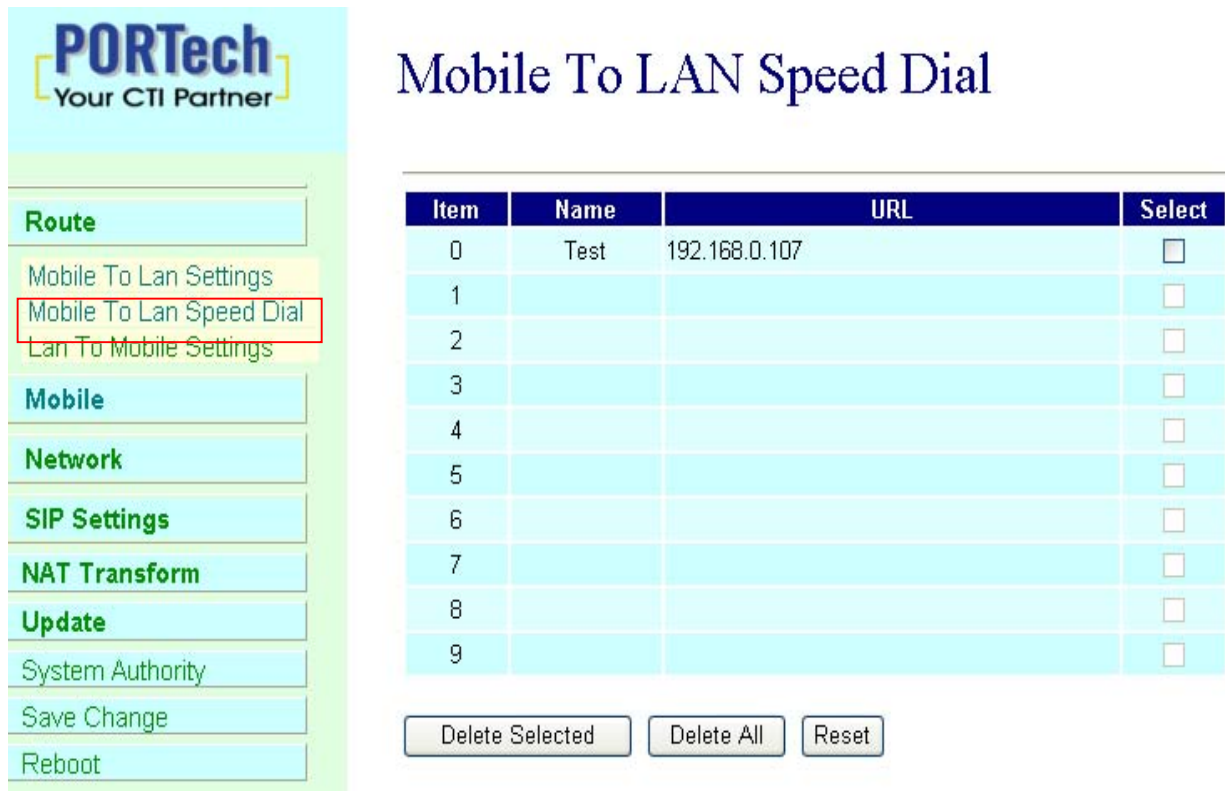

PORTech
Your CTI Partner

Mobile To LAN Speed Dial

Item	Name	URL	Select
0	Test	192.168.0.107	<input type="checkbox"/>
1			<input type="checkbox"/>
2			<input type="checkbox"/>
3			<input type="checkbox"/>
4			<input type="checkbox"/>
5			<input type="checkbox"/>
6			<input type="checkbox"/>
7			<input type="checkbox"/>
8			<input type="checkbox"/>
9			<input type="checkbox"/>

Delete Selected Delete All Reset

*The call will be answered and prompt dial tone again. When the caller may enter the “Num”, system will connect the “URL” as destination.

E.g Num:0 Name:test URL:192.168.0.107

When the caller hear dial tone and enter 0, system will connect 192.168.0.107

9.3 LAN to Mobile Settings

The operator may assign 50 sets of routing rule to transfer the call incoming from LAN to MOBILE.

PORTech
Your CTI Partner

LAN To Mobile Table

Page: 1

Item	URL	Call Num	Select
0	*	#	<input type="checkbox"/>
1			<input type="checkbox"/>
2			<input type="checkbox"/>
3			<input type="checkbox"/>
4			<input type="checkbox"/>
5			<input type="checkbox"/>
6			<input type="checkbox"/>
7			<input type="checkbox"/>
8			<input type="checkbox"/>
9			<input type="checkbox"/>

Delete Selected Delete All Reset

The MV-372 will transfer to the mobile number according to the incoming URL

*URL : The IP address of the incoming call.

may enter the whole IP address, e.g. 192.168.0.101 or proxy server's extension. If a simple "*" is entered, means no restriction for the incoming IP address.

*Call Num :

- 1.may enter the whole number, e.g. 0911111111
- 2.a simple "*"means 2-stages-dialing. The call will be answered and prompt dial tone again to receive the called number as the destination, e.g. 0911111111 or 0911111111#
- 3.#['d'n]['a'ppp] for one-stage dialing
[...] is option
'd'n means to delete the beginning n codes,
'a'ppp means to add 'ppp' in front.
for example #d2a09 means one-stage dialing,
delete the first 2 codes from your destination number,
then add 09 in front as the new destination number.

Example:

Lan to Mobile: *, #

- (1)MV-372 and Lan Phone both need to register proxy server or Asterisk.
- (2)Proxy server/asterisk set the route that the prefix of destination number
- (3)When you dial any destination phone number from lan phone,MV-372 will connect this call auto.

Example of Application:

When you call the ch.1 MV-372 gsm number,it will provide dial tone and you enter a destination number.

Then ch.2 MV-372 will dial this number and connect.

ch.1 MV-372: mobile to lan set route table *,*

ch.2 MV-372:lan to mobile set route table *,#

Additionally, two channels MV-372 both need to register proxy server or Asterisk.

And proxy server/asterisk set the route that the prefix of destination number dial out from ch.2 MV-372.

*The channel 2 MV-372's ip: the first ip + :5062 (e.g http://192.168.0.100:5062)

10.Mobile

10.1 Mobile Status

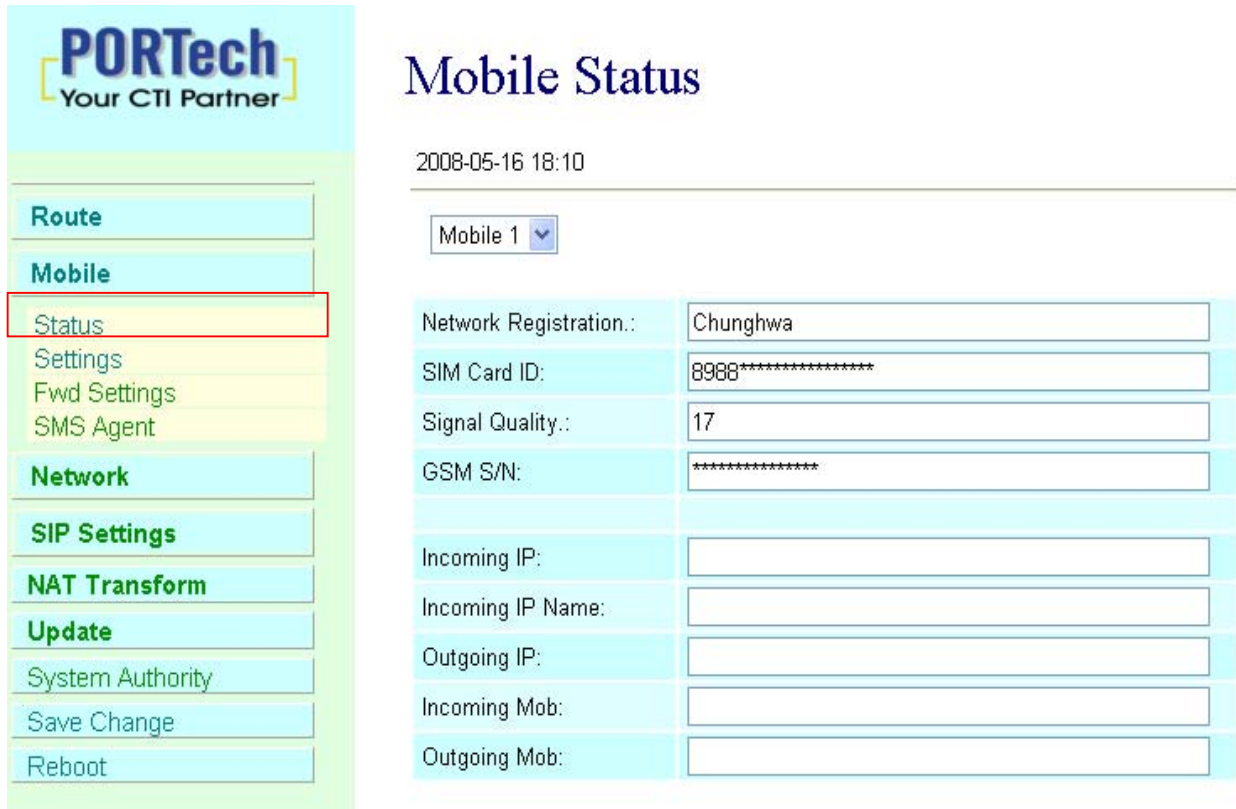

Mobile Status	
2008-05-16 18:10	
Mobile 1	
Network Registration.:	Chunghwa
SIM Card ID:	8988*****
Signal Quality.:	17
GSM S/N:	*****
Incoming IP:	
Incoming IP Name:	
Outgoing IP:	
Incoming Mob:	
Outgoing Mob:	

- (1)Network Registration : The telecom carrier which the SIM card been registered.
- (2)SIM Card ID : SIM card ID.
- (3)Signal Quality : Signal quality.
- (4)GSM S/N : IMEI Number
- (5)Incoming IP : The IP address of the last incoming call from LAN.
- (6)Incoming IP Name: proxy server name
- (7)Outgoing IP : The IP address of the last outgoing call to LAN.
- (8)Incoming Mob : The caller ID of the last incoming call from MOBILE.
- (9)Outgoing Mob : The called number of the last outgoing call to MOBILE.

10.2 Mobile Setting

PORTech
Your CTI Partner

- Route
- Mobile**
 - Status
 - Settings
 - Fwd Settings
 - SMS Agent
- Network
- SIP Settings
- NAT Transform
- Update
 - System Authority
 - Save Change
 - Reboot

Mobile Setting

(1) VoIP Tx Gain:	9 (0~12)	(2) VoIP Rx Gain:	11 (0~15)
(3) LAN Dialtone Gain:	9 (0~12)		
(4) Mobile 1 <input checked="" type="radio"/> ON <input type="radio"/> OFF			
(5) Routing Range:	0 to 49 (0~49)		
(6) CODEC Tx Gain:	6 (0~7)	(7) CODEC Rx Gain:	6 (0~7)
(8) SIP From:	Tel/User (Standard)	Answer Delay:	0 (0~15) (12)
(9) CLID Presentation:	<input type="radio"/> Suppression <input checked="" type="radio"/> Invocation		
(10) Mobile PIN Code:	On <input type="checkbox"/> Code: <input type="text"/>	Confirmed:	<input type="text"/>
(11) LAN Answer Mode:	<input checked="" type="radio"/> Answered <input type="radio"/> Alerted <input type="radio"/> Income		
Mobile 2 <input checked="" type="radio"/> ON <input type="radio"/> OFF			
Routing Range:	0 to 49 (0~49)		
CODEC Tx Gain:	6 (0~7)	CODEC Rx Gain:	6 (0~7)
SIP From:	Tel/User (Standard)	Answer Delay:	0 (0~15)
CLID Presentation:	<input type="radio"/> Suppression <input checked="" type="radio"/> Invocation		
Mobile PIN Code:	On <input type="checkbox"/> Code: <input type="text"/>	Confirmed:	<input type="text"/>
LAN Answer Mode:	<input checked="" type="radio"/> Answered <input type="radio"/> Alerted <input type="radio"/> Income		
Submit		Reset	

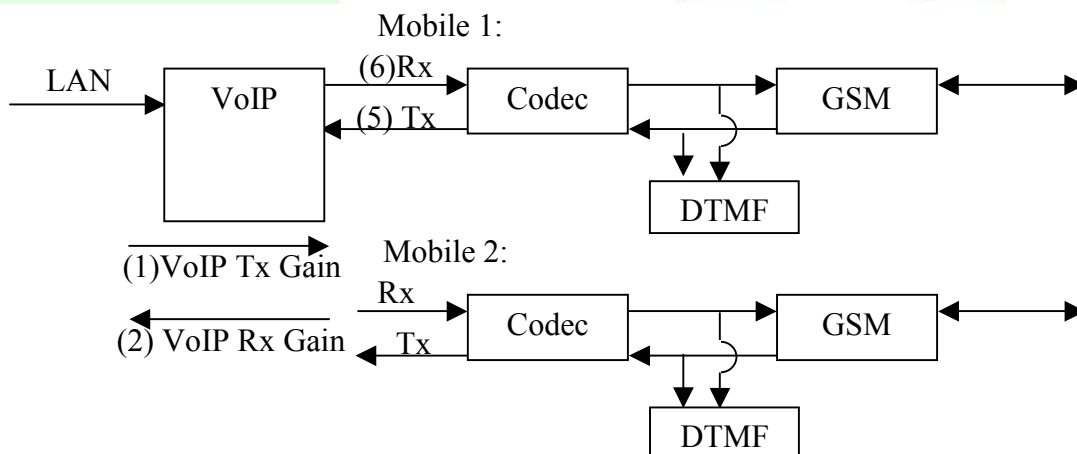

(1) VoIP Tx Gain: To adjust the volume of LAN side.

(2) VoIP Rx Gain: To adjust the volume of Mobile side.

(3) LAN Dialtone Gain: DTMF Receiver is not good, you can adjust gain down.

(4) ON/Off: If you use this channel, please click on. Otherwise, please click off.

(5) Routing Range: The route table -50 sets can share by two channels

ex: Mobile 1 use the route table for item 0-24,

Mobile 2 use the route table for item 25-49

(6) CODEC Tx Gain: as above

(7) CODEC Rx Gain: as above

(8) SIP From: Caller ID transfer

- Tel/User(Standard): If you need to register to Asterisk and proxy server, please choose this option. And how to transfer the caller ID to LAN, please refer 21. How to setup Asterisk to receive Caller ID from MV-372 (page 42)

MV-372 will send the message as follows in the Packet.

From: " caller number " <sip:3001@192.168.0.228>;tag=51088abb

- Tel/Tel :

MV-372 will send the message as follows in the Packet.

From: "caller number" <sip: caller number @192.168.0.228>;tag=6ac93f7c

- ※ Please note: If you choose this option, please don't register to Asterisk and proxy server. Please only fill and choose (else field empty) in sip setting/service domain

- User/Tel

MV-372 will send the message as follows in the Packet.

From: " Username " <sip: caller number @192.168.0.228>;tag=7f130947

- ※ If you choose this option, please don't register to Asterisk and proxy server. Please only fill and

choose Active: on (else field empty) in sip setting/service domain

(9)Presentation CLIR : If you need to block the Caller Id for call termination,please choose Suppression

(10)Mobile PIN Code:If you need to unlock pin code via MV-372,you can click "On" and enter pin code.

(11)LAN Answer Mode:

Answered : when mobile answer,then connect the call

Alerted : when the mobile is ringing back tone,then connect the call

Income : when lan dial out,then connect soon

(12)Answer Delay: Delay for incoming call when the ring.

(13)When you buy Quad band,you need to choose your GSM frequency

10.3 Mobile / Forward Setting :

When the first route are busying, SIP can transfer phone call to another free route. When the device are busying, the phone call can be transfer to another device (external equipments).



- Route
- Mobile
- Status
- Settings
- Fwd Settings
- SMS Agent
- Network
- SIP Settings
- NAT Transform
- Update
- System Authority
- Save Change
- Reboot

Forward Setting

Forward Enable

	Name	URL:Port
Fwd to Mobile1:	<input type="text"/>	192.168.0.100:5060
Fwd to Mobile2:	<input type="text"/>	192.168.0.100:5062
Fwd to External:	<input type="text"/>	<input type="text"/>

- * "Forward Enable" is not motivate on Default value.
 So please, mark "Forward Enable" this blank to motivate this function.
 Take SJ Phone for example: Profiles -> Edit -> Advanced -> Accept redirection replies (Turn on the "Forward Enable", therefore the SJ Phone can designate a port which are free to use.)

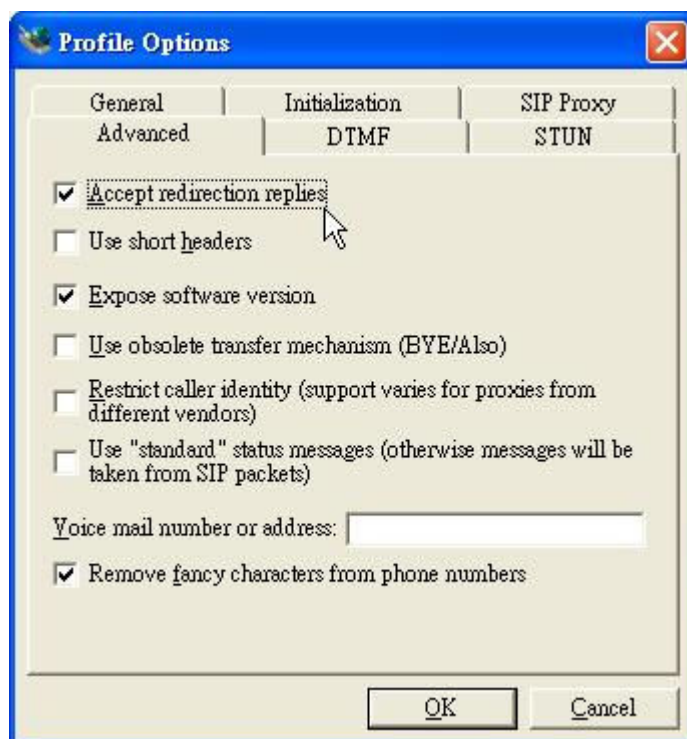

	Name	URL:Port
Fwd to Mobile1:		192.168.0.100:5060
Fwd to Mobile2:		192.168.0.100:5062
Fwd to External:		

The Explanation of Picture:

Fwd to Mobile1:192.168.0.100 : 5060, it means when 5062 Port are busying, SJ Phone can transfer the call to 5060 Port (192.168.0.100).

Fwd to Mobile2:192.168.0.100 : 5062, it means when 5060 Port are busying, SJ Phone can transfer the call to 5062 Port (192.168.0.100).

- If both 5060 port and 5062 port are busying at same time, you can set up "Fwd to External", then you can transfer the phone call to another designate device.

10.4 Mobile / SMS Agent :

PORTech
Your CTI Partner

SMS Agent

Port	Status	Bank
Mobile 1	Standby.	Rx List
Mobile 2	Standby.	Rx List

SMS Sender

Via: Mobile 1 2

Dest Num:

Message:

Maximum Number of UCS2 chars for this text box is 70.

You have 70 UCS2 chars remaining for your description...

Send Now

- (1) Rx List: Read received SMS
- (2) Dest Num: the Receiver's phone number
- (3) Message: Please fill the message that want to send to receiver.

When you click Rx List, you can view all received SMS as follows.

SMS Rx List

Read	Status	RemotelD	Date,Time
1	REC READ	886936114545	08/01/01,19:34:22
2	REC READ	886935386862	08/03/12,16:25:27

Click the serial no,you can view message as follows.

SMS Reader

Index	RemotelD	Date,Time
2	886935386862	08/03/12, 16:25:27

MV Serial can send SMS and receive SMS

[Back](#) [Delete](#)

11.Network

In Network you can check the Network status, configure the WLAN Settings , LAN Setting and SNTP settings.

11.1 Network Status: You can check the current Network setting in this page.



Network Status

Ethernet 0	WAN Interface	LAN Interface
Type	Fixed IP Client	Fixed IP Client
IP	192.168.0.122	192.168.0.102
Mask	255.255.255.0	255.255.255.0
Gateway	192.168.0.254	192.168.0.254
MAC	00037E009999	00037E008888

11.2 WAN Settings: You can check the current Network setting in this page.

- (1) The TCP/IP Configuration item is to setup the WAN port's network environment. You may refer to your current network environment to configure the system properly.
- (2) The PPPoE Configuration item is to setup the PPPoE Username and Password. If you have the PPPoE account from your Service Provider, please input the Username and the Password correctly.
- (3) The Bridge Item is to setuo the system Bridge mode Enable/Disable. If you set the Bridge On, then the two Fast Ethernet ports will be transparent.
- (4) When you finished the setting, please click the Submit button.

PORTech
Your CTI Partner

WAN Settings

You could configure the WAN settings in this page.

Network Mode: Bridge NAT

WAN Setting

IP Type: Fixed IP DHCP Client PPPoE

IP: 192.168.0.122

Mask: 255.255.255.0

Gateway: 192.168.0.254

DNS Server1: 168.95.192.1

DNS Server2: 168.95.1.1

MAC: 00037e009999

PPPoE Setting

User Name:

Password:

11.3 LAN Settings: You can check the current Network setting in this page.

-
- (1) The TCP/IP Configuration item is to setup the WAN port's network environment. You may refer to your current network environment to configure the system properly.
 - (2)DHCP Server: You may refer to your current network environment to configure the system properly



LAN Settings

LAN Setting

IP:	<input type="text" value="192.168.0.102"/>
Mask:	<input type="text" value="255.255.255.0"/>
MAC:	<input type="text" value="00037e008888"/>

DHCP Server

DHCP Server:	<input type="radio"/> On <input checked="" type="radio"/> Off
Start IP:	<input type="text" value="150"/>
End IP:	<input type="text" value="200"/>
Lease Time:	<input type="text" value="1"/> : <input type="text" value="0"/> (dd:hh)

11.4 SNTP Settings:

SNTP Setting function: you can setup the primary and second SNTP Server IP Address, to get the date/time information. Also you can base on your location to set the Time Zone, and how long need to synchronize again. When you finished the setting, please click the Submit button.

PORTech
Your CTI Partner

- Route
- Mobile
- Network**
- Status
- WAN Settings
- LAN Settings
- SNTP Settings
- SIP Settings
- NAT Transform
- Update
- System Authority
- Save Change
- Reboot

SNTP Settings

You could set the SNTP servers in this page.

SNTP: On Off

Primary Server:

Secondary Server:

Time Zone: GMT - : (hh:mm)

Sync. Time: : : (dd:hh:mm)

12.SIP Setting

In SIP Setting you can setup the Service Domain,Port Settings,Codec Settings,RTP setting,RPort Setting and Other SettingS. If the VoIP service is provided by ISP,you need to setup the related informations correctly then you can register to SIP Proxy Server correctly.

12.1 In Servcie Domain Function you need to input the account and the related informations in this page,please refer to your ISP Provider. You can register three SIP accounts . You can dial the VoIP phone to your friends via first enable SIP account and receive the phone from the tree SIP account.

First you need to click Active to enable the Service Domain,then you can input the following items.

- (1)No.,: choose Mobile 1 or Mobile 2
- (2) Display name: you can input the name you want to display.
- (3) User name: you need to input the User Name get from your ISP.
- (4) Register Name: you need to input the Register Name get from your ISP.
- (5) Register Password: you need to input the Register Password get from ISP.
- (6) Domain Server:you need to input the Domain Server get from your ISP.
- (7) Proxy Server:you need to input the Proxy Server get from your ISP.
- (8) Outbound Proxy: you need to input the Outbound Proxy get from your ISP. If your ISP does not provide the information,then you can skip this item.
- (9) You can see the Register Status in the Status item.
- (10) When you finished the setting,please click the Submit button.
Remember to click "Save Charge"

Service Domain Settings

Route
Mobile
Network
SIP Settings
Service Domain
Port Settings
Codec Settings
Codec ID Setting
DTMF Setting
RPort Setting
SIP Responses
Other Settings
NAT Transform

Mobile 1 ▾

Realm 1 (Default)	
Active:	<input checked="" type="radio"/> ON <input type="radio"/> OFF
Display Name:	<input type="text" value="3001"/>
User Name:	<input type="text" value="3001"/>
Register Name:	<input type="text" value="3001"/>
Register Password:	<input type="password" value="****"/>
Domain Server:	<input type="text"/>
Proxy Server:	<input type="text" value="61.218.151.230"/>
Outbound Proxy:	<input type="text"/>
Status:	Not Registered

Example:
Register VoipBuster

Realm 1 (Default)	
Active:	<input checked="" type="radio"/> On <input type="radio"/> Off
Display Name:	<input type="text" value="jenny0922"/>
User Name:	<input type="text" value="jenny0922"/> Your Voipbuster username
Register Name:	<input type="text" value="jenny0922"/>
Register Password:	<input type="password" value="****"/> Your Voipbuster password
Domain Server:	<input type="text"/>
Proxy Server:	<input type="text" value="194.221.62.207"/> Proxy Server's IP
Outbound Proxy:	<input type="text"/>
Status:	Registered

12.2 Port Setting

You can setup the SIP and RTP port number in this page. Each ISP provider will have different SIP/RTP port setting, please refer to the ISP to setup the port number correctly. When you finished the setting, please click the Submit button.

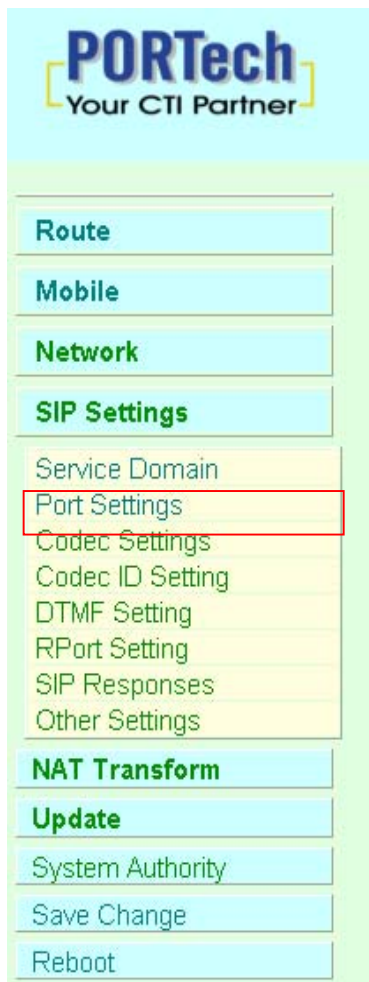

PORTech
Your CTI Partner

- Route
- Mobile
- Network
- SIP Settings**
 - Service Domain
 - Port Settings**
 - Codec Settings
 - Codec ID Setting
 - DTMF Setting
 - RPort Setting
 - SIP Responses
 - Other Settings
- NAT Transform
- Update
- System Authority
- Save Change
- Reboot

Ports Setting

Port of Mobile 1		
SIP Port:	<input type="text" value="5060"/>	(1024~65535)
RTP Port:	<input type="text" value="60000"/>	(1024~65535)

Port of Mobile 2		
SIP Port:	<input type="text" value="5062"/>	(1024~65535)
RTP Port:	<input type="text" value="60100"/>	(1024~65535)

12.3 Codec Settings:

You can setup the Codec priority, RTP packet length in this page. You need to follow the ISP suggestion to setup these items. When you finished the setting, please click the Submit button.

PORTech
Your CTI Partner

- Route
- Mobile
- Network
- SIP Settings**
 - Service Domain
 - Port Settings
 - Codec Settings**
 - Codec ID Setting
 - DTMF Setting
 - RPort Setting
 - SIP Responses
 - Other Settings
- NAT Transform
- Update
 - System Authority
 - Save Change
 - Reboot

Codec Settings

Codec Priority	
Codec Priority 1:	G.711 u-law
Codec Priority 2:	G.711 a-law
Codec Priority 3:	G.723
Codec Priority 4:	G.729
Codec Priority 5:	G.726 - 16
Codec Priority 6:	G.726 - 24
Codec Priority 7:	G.726 - 32
Codec Priority 8:	G.726 - 40

RTP Packet Length	
G.711 & G.729:	20 ms
G.723:	30 ms

G.723 5.3K	
G.723 5.3K:	<input type="radio"/> On <input checked="" type="radio"/> Off

Voice VAD	
Voice VAD:	<input type="radio"/> On <input checked="" type="radio"/> Off

12.4 Codec ID Setting

You can setup the Codec ID in this page.

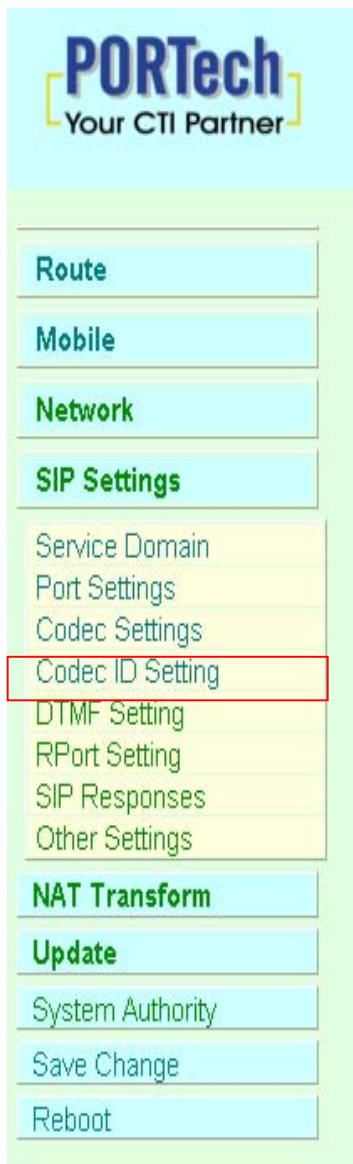

PORTech
Your CTI Partner

- Route
- Mobile
- Network
- SIP Settings**
 - Service Domain
 - Port Settings
 - Codec Settings
 - Codec ID Setting**
 - DTMF Setting
 - RPort Setting
 - SIP Responses
 - Other Settings
- NAT Transform
- Update
- System Authority
- Save Change
- Reboot

Codec ID Setting

You could set the value of Codec ID in this page.

Codec Type	ID	Default Value
G726-16 ID:	<input type="text" value="23"/> (95~255)	<input checked="" type="checkbox"/> 23
G726-24 ID:	<input type="text" value="22"/> (95~255)	<input checked="" type="checkbox"/> 22
G726-32 ID:	<input type="text" value="2"/> (95~255)	<input checked="" type="checkbox"/> 2
G726-40 ID:	<input type="text" value="21"/> (95~255)	<input checked="" type="checkbox"/> 21
RFC 2833 ID:	<input type="text" value="101"/> (95~255)	<input checked="" type="checkbox"/> 101

Submit

Reset

12.5 DTMF Setting

You can setup the DTMF Setting in this page.

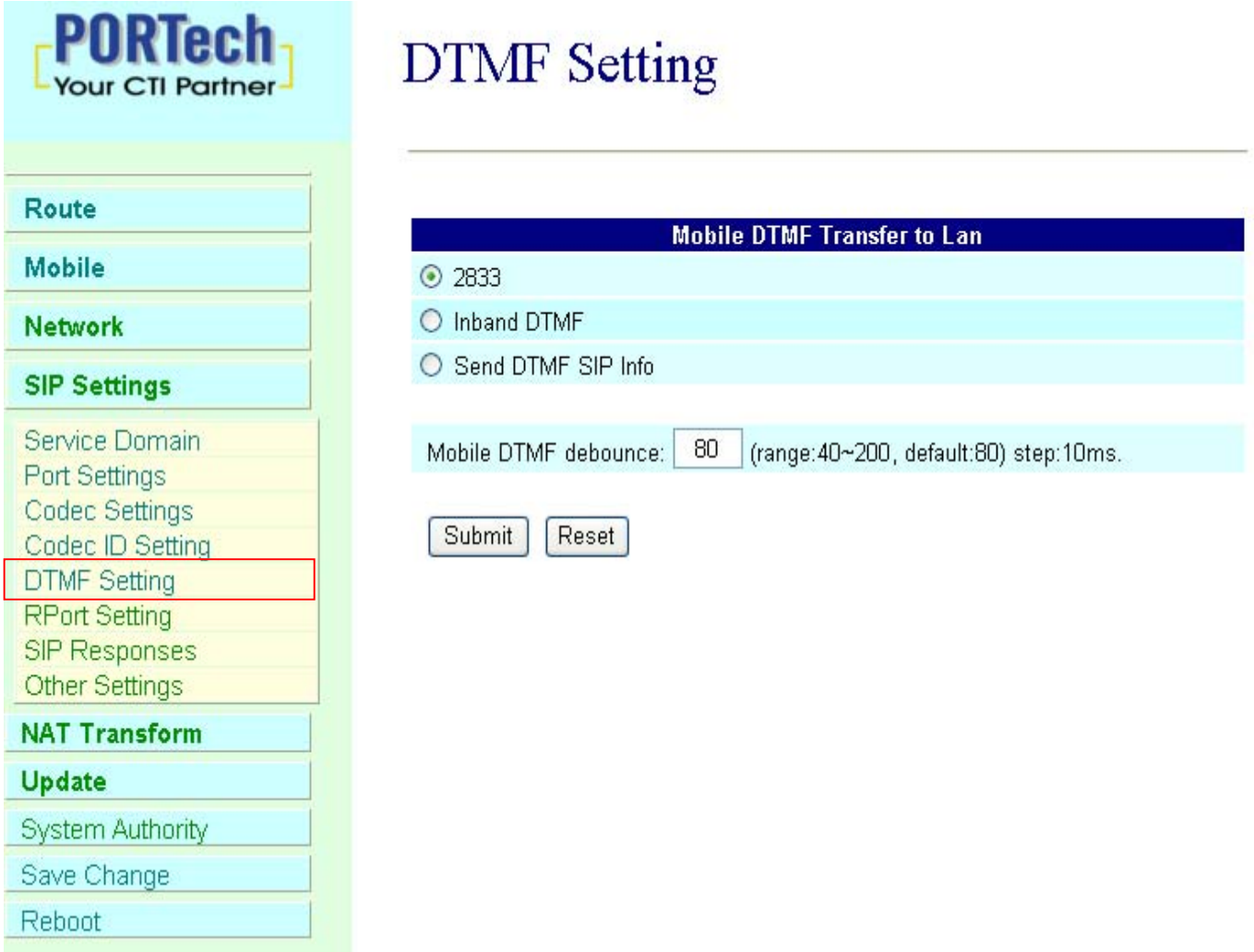

PORTech
Your CTI Partner

DTMF Setting

Mobile DTMF Transfer to Lan

2833

Inband DTMF

Send DTMF SIP Info

Mobile DTMF debounce: (range:40~200, default:80) step:10ms.

12.6 RPort Function:

You can setup the RPort Enable/Disable in this page. To change this setting, please following your ISP information. When you finished the setting, please click the Submit button.

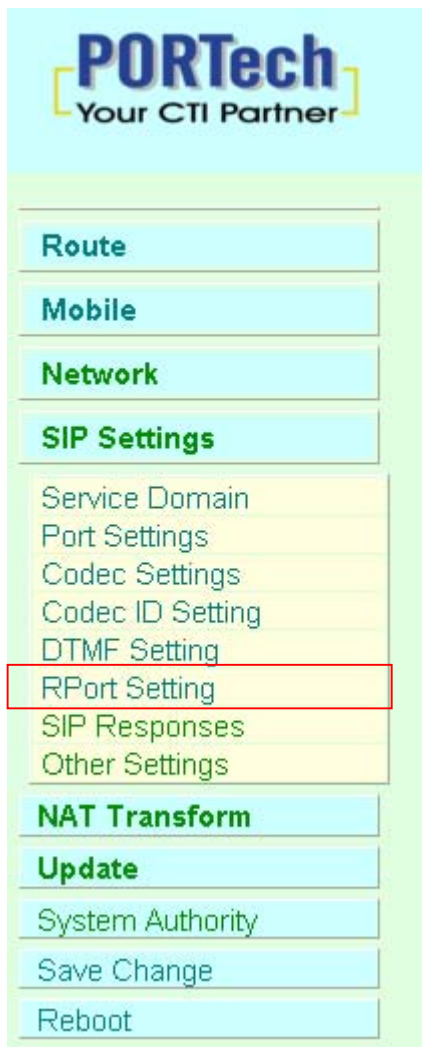

PORTech
Your CTI Partner

- Route
- Mobile
- Network
- SIP Settings**
 - Service Domain
 - Port Settings
 - Codec Settings
 - Codec ID Setting
 - DTMF Setting
 - RPort Setting**
 - SIP Responses
 - Other Settings
- NAT Transform
- Update
 - System Authority
 - Save Change
 - Reboot

RPort Setting

RPort of Mobile 1: On Off
RPort of Mobile 2: On Off

Submit

Reset

12.7 SIP Responses

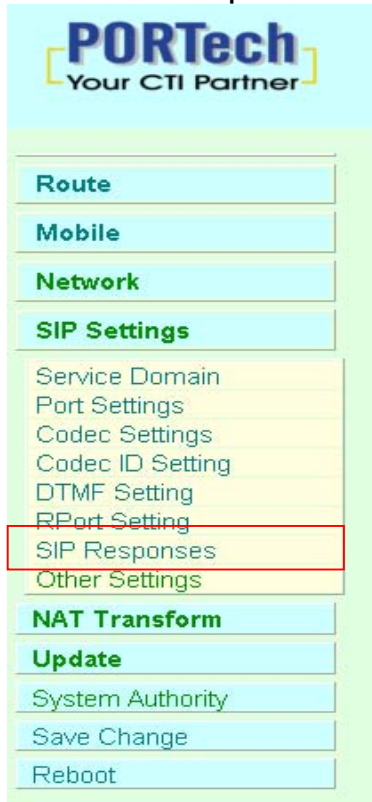

PORTech
Your CTI Partner

Route

Mobile

Network

SIP Settings

Service Domain

Port Settings

Codec Settings

Codec ID Setting

DTMF Setting

RPort Setting

SIP Responses

Other Settings

NAT Transform

Update

System Authority

Save Change

Reboot

SIP Responses Setting

Response on port busy.	
<input checked="" type="radio"/> 486	Busy here
<input type="radio"/> 503	Service unavailable

SIP Responses	
<input checked="" type="radio"/> ON <input type="radio"/> OFF	180 Ringing (Auto force to ON, if 183 was OFF.)
<input type="radio"/> ON <input checked="" type="radio"/> OFF	183 Session Progress

12.7.1 486(busy here), 503(Service unavailable): When Device are busying, you can select 486 or 505 to response to SIP.

12.7.2 180 Ring on/off: LAN TO MOBILE two stage dialing can be turn off, therefore there will be no the Ring Back Tone, all the phone call will be transferred to Voice-Mail directly. (For this function, 183 must be turn on)

12.7.3 183(Session Progress)-->[It means"on progressing"] : When you turn 183 on, it means you can hear voicemail while GMS side are busying. We recommend you to turn this on if you use SIP Proxy.

12.8 Other Settings

Other Settings: you can setup the Hold by RFC and QoS in this page. To change these settings. please following your ISP information. When you finished the setting, please click the Submit button. The QoS setting is to set the voice packets' priority. If you set the value higher than 0, then the voice packets will get the higher priority to the Internet. But the QoS function still need to cooperate with the others Internet devices.



- Route
- Mobile
- Network
- SIP Settings**
 - Service Domain
 - Port Settings
 - Codec Settings
 - Codec ID Setting
 - DTMF Setting
 - RPort Setting
 - SIP Responses
 - Other Settings**
- NAT Transform
- Update
 - System Authority
 - Save Change
 - Reboot

Other Settings

Hold by RFC of Mobile 1 On Off

Hold by RFC of Mobile 2 On Off

Voice QoS: (0~63)

SIP QoS: (0~63)

SIP Expire Time: (60~86400 sec)

13. NAT Trans

In NAT Trans. you can setup STUN and uPnP function. These functions can help your VoIP device working properly behind NAT.

13.1 STUN Setting: you can setup the STUN Enable/Disable and STUN Server IP address in this page. This function can help your VoIP device working properly behind NAT. To change these settings please following your ISP information. When you finished the setting, please click the Submit button.

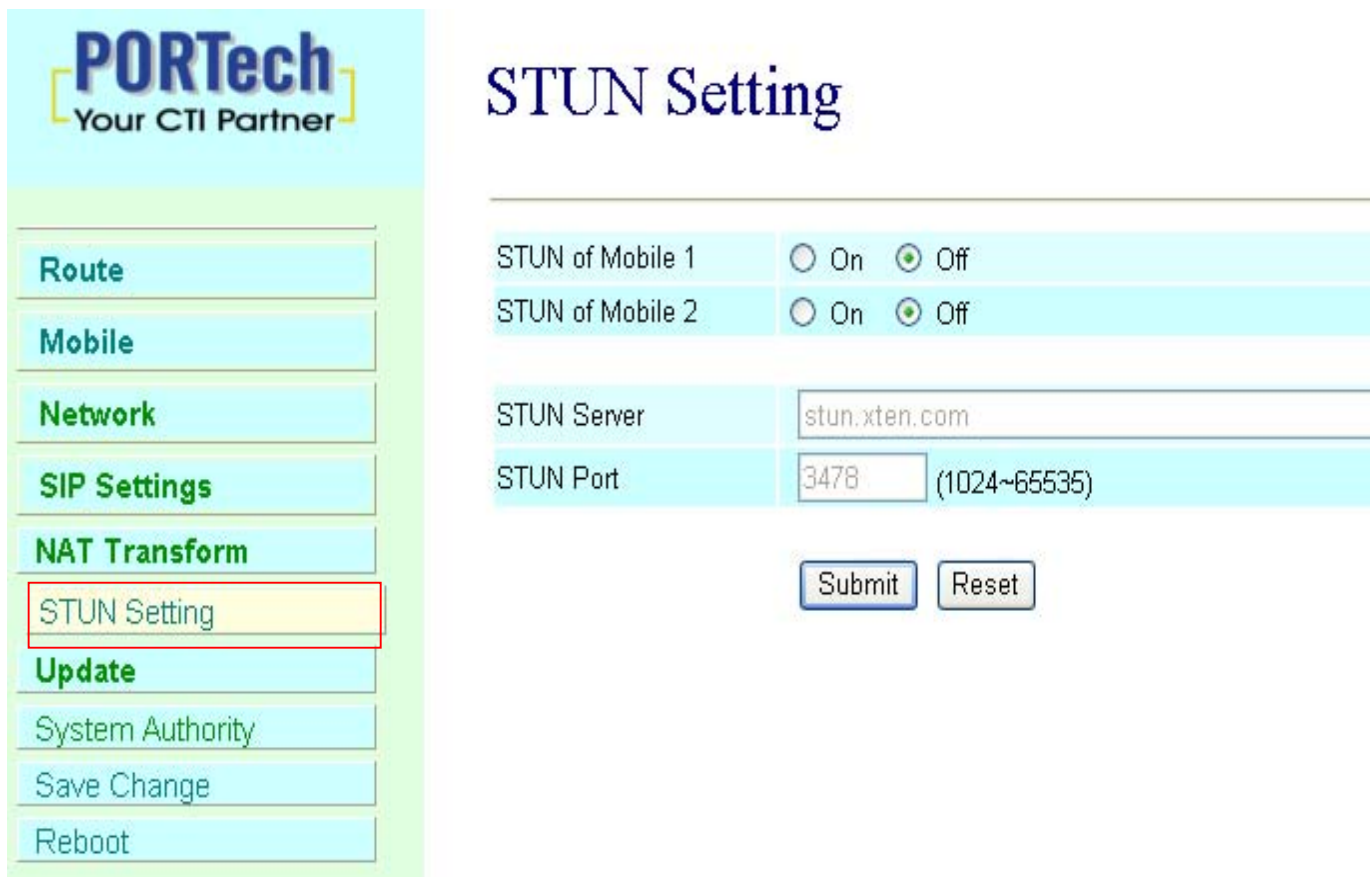

PORTech
Your CTI Partner

STUN Setting

STUN of Mobile 1 On Off

STUN of Mobile 2 On Off

STUN Server

STUN Port (1024~65535)

14. System Auth.

In System Authority you can change your login name and password.



System Authority

You could change the login username/password in this page.

New username:	<input type="text"/>
New password:	<input type="password"/>
Confirmed password:	<input type="password"/>
	<input type="button" value="Submit"/> <input type="button" value="Reset"/>

15. Save Change

In Save Change you can save the changes you have done. If you want to use new setting in the VoIP system, You have to click the Save button. After you click the Save button, the system will automatically restart and the new setting will effect.



Save Changes

You have to save changes to effect them.

Save Changes:

16.Update

In Update you can update the system's firmware to the new one or do the factory reset to let the system back to default setting.

16.1 Update firmware

- (1) In New Firmware function you can update new firmware via HTTP in this page. You can upgrade the firmware by the following steps:
- (2) Select the firmware code type, Risc code.
- (3) Click the "Browse" button in the right side of the File Location or you can type the correct path and the filename in File Location blank.
- (4) Select the correct file you want to download to the system then click the Update button.
- (5) Please click update/default setting after update firmware

PORTech
Your CTI Partner

Update Firmware

You could update the newest firmware. PCB mark: 2K123B

Method: HTTP TFTP

HTTP

Code Type: Risc

File Location: 瀏覽...

TFTP

TFTP Server: 192.168.1.250

Update Reset

16.2 Restore Default Settings

In this page: Update/ Default Settings, you could restore the factory default settings to the system. **All setting will restore default setting. IP will retain original IP as usual not default IP.**



Restore Default Settings

You could click the restore button to restore the factory settings.

Restore default settings:

17.Reboot

Reboot function you can restart the system. If you want to restart the system, you can just click the Reboor button, then the system will automatically.



Reboot System

You could press the reboot button to restart the system.

Reboot system:

18. IP Setting

The operator can setup or query the network parameters by dialing in the mobile number which it SIM card has been put in the main body. The status or result is response by voice. In the first 20 seconds after power-on, the VoIP GSM Gateway enters the IP setting mode. The operator may dial in the mobile number during this period to set or query the network parameters.

Item	IVR Action	IVR Menu Choice	Notes
1	Reboot	#195#	After you hear "Option Successful," hang-up. Unit will reboot automatically.
2	Factory Reset	#198#	System will automatically Reboot.WARNING: ALL User-Changeable" NONDEFAULT SETTINGS WILL BE LOST! This will include network and service provider data.
3	Check IP Address	#120#	IVR will announce the current IP address , Default : 192.168.0.100
4	Check IP Type	#121#	IVR will announce if DHCP is enabled or disabled. default : OFF
5	Check Network Mask	#123#	IVR will announce the current network mask.Default : 255.255.255.0
6	Check Gateway IP Address	#124#	IVR will announce the current gateway IP address, Default : 192.168.0.254
7	Check Primary	#125#	IVR will announce the current

	DNS Server		setting in the Primary DNS field. Default : 192.168.0.1
8	Check Firmware Version	#128#	IVR will announce the version of the firmware running
9	Set as DHCP client	#111#	The system will change to DHCP Client type
10	Set Static IP Address	#112xxx*xxx*xxx*xxx#	DHCP will be disabled and system will change to the Static IP type. Enter IP address using numbers on the telephone key pad. Use the * (star) key when entering a decimal point.
11	Set Network Mask	#113xxx*xxx*xxx*xxx#	Must set Static IP first. Enter value using numbers on the telephone key pad. Use the * (star) key when entering a decimal point.
12	Set Gateway IP Address	#114xxx*xxx*xxx*xxx#	Must set Static IP first. Enter IP address using numbers on the telephone key pad. Use the * (star) key when entering a decimal point.
13	Set Primary DNS Server	#115xxx*xxx*xxx*xxx#	Must set Static IP first. Enter IP address using numbers on the telephone key pad. Use the * (star) key when entering a decimal point.

19. Specification

19.1 Protocols

SIP (RFC2543,RFC3261)

19.2 TCP/IP

IP/TCP/UDP/RTP/RTCP/

CMP/ARP/RARP/SNTP

DHCP/DNS Client

IEEE802.1P/Q

ToS/DiffServ

NAT Traversal

STUN

uPnP

IP Assignment

Static IP

DHCP

PPPoE

19.3 Codec

G.711 u-Law

G.711 a-Law

G.723.1 (5.3k)

G.723.1 (6.3k)

G.729A

G.729A/B

19.4 Voice Quality

VAD

CNG

AEC, LEC

Packet loss

19.5 GSM (MV-372)

Dual BAND: 900/1800 MHZ

Tri BAND(BenQ M23): 900/1800/1900 MHZ

Tri BAND(Siemens MC56): 850/1800/1900 MHZ

Quad BAND: 900/1800/1900/850 MHZ

20. Appendix: Setup MV-372 with Asterisk

20.1 Usage

A typical usage of such a gateway is to be able to give a call with your normal mobile to any destination at voip cost :

Your mobile <----*gsm network*----> MV-372 <--*lan*--> Asterisk
<--*internet*--> VOIP provider <--*whatever*--> landline

To do such a call, you just call your MV-372 number (it has its own simcard), then you get an invitation tone, then you dial the number which is handled by Asterisk.

If you have some special deals with your mobile operator, like free special number, you can call your MV-372 for free.

You can then call all around the world from your mobile at voip cost :-)

20.2 MV-372 Configuration

Once you've configured everything in the box, one good advice is to unplug the power and to restart it. By this way you should have all the parameters taken into account.

To have the MV-372 to work with Asterisk, you need first to configure the

box.

Here are some screen shots showing all the important parameters. You have to note that in all the configuration process, the MV-372 is considered as extension '103' of the IPBX.

In **Bold** are the parameters depending on your installation

WAN Settings

You could configure the WAN settings in this page.

WAN Setting	
IP Type	<input checked="" type="radio"/> Fixed IP <input type="radio"/> DHCP Client <input type="radio"/> PPPoE
IP	<input type="text" value="MV370 IP"/>
Mask	<input type="text" value="255.255.255.0"/>
Gateway	<input type="text" value="Router IP"/>
DNS Server1	<input type="text" value="168.95.192.1"/>
DNS Server2	<input type="text" value="168.95.1.1"/>
MAC	<input type="text"/>

PPPoE Setting	
User Name	<input type="text"/>
Password	<input type="text"/>

Here the '#' is important to avoid the two stage dialing when you give a call from Asterisk to GSM.

LAN To Mobile Table

Page: 1

Item	URL	Call Num	Select
0	Your Asterisk IP	#	<input type="checkbox"/>
1			<input type="checkbox"/>
2			<input type="checkbox"/>
3			<input type="checkbox"/>
4			<input type="checkbox"/>
5			<input type="checkbox"/>
6			<input type="checkbox"/>
7			<input type="checkbox"/>
8			<input type="checkbox"/>
9			<input type="checkbox"/>

Mobile To LAN Table

Page: 1

Item	CID	URL	Select
0	Authorised Mobile	103	<input type="checkbox"/>
1	Another Authorised Mobile	103	<input type="checkbox"/>
2			<input type="checkbox"/>
3			<input type="checkbox"/>
4			<input type="checkbox"/>
5			<input type="checkbox"/>
6			<input type="checkbox"/>
7			<input type="checkbox"/>
8			<input type="checkbox"/>
9			<input type="checkbox"/>

The mobile number you give in that page are the authorised mobile which can call GSM to Asterisk.

These mobile number must be defined as your GSM provider displays the number.

If you don't know how it is displayed, just give a call to the box and check the number given in the 'Incoming Mob' field of the 'Mobile Status' page. Any number which is not in that list won't have access to the LAN side, so to Asterisk.

If you want to allow any number, just set '*' in that field ... but beware of the bill ;-)

Service Domain Settings

Realm 1 (Default)	
Active:	<input checked="" type="radio"/> ON <input type="radio"/> OFF
Display Name:	<input type="text" value="103"/>
User Name:	<input type="text" value="103"/>
Register Name:	<input type="text" value="103"/>
Register Password:	<input type="text"/>
Domain Server:	<input type="text" value="Asterisk IP"/>
Proxy Server:	<input type="text"/>
Outbound Proxy:	<input type="text"/>
Status:	Not Registered

Once Asterisk configuration is made, you should get 'Registered' on the Realm1.

Codec Settings

Codec Priority	
Codec Priority 1:	<input type="text" value="G.711 u-law"/>
Codec Priority 2:	<input type="text" value="G.711 a-law"/>
Codec Priority 3:	<input type="text" value="Not Used"/>
Codec Priority 4:	<input type="text" value="Not Used"/>
Codec Priority 5:	<input type="text" value="Not Used"/>
Codec Priority 6:	<input type="text" value="Not Used"/>
Codec Priority 7:	<input type="text" value="Not Used"/>
Codec Priority 8:	<input type="text" value="Not Used"/>

RTP Packet Length	
G.711 & G.729:	<input type="text" value="20 ms"/>
G.723:	<input type="text" value="30 ms"/>

G.723 5.3K	
G.723 5.3K:	<input type="radio"/> On <input checked="" type="radio"/> Off

Voice VAD	
Voice VAD:	<input type="radio"/> On <input checked="" type="radio"/> Off

It is very important to use only u-law or a-law as all DTMF is inband. So if you want to be able to do some DISA when you call from GSM to Asterisk, it has to be one of these 2 codecs.

Mobile Setting

VoIP Tx Gain:	<input type="text" value="10"/> (0~12)	VoIP Rx Gain:	<input type="text" value="3"/> (0~15)
LAN Dialtone Gain:	<input type="text" value="10"/> (0~12)		
Mobile <input checked="" type="radio"/> ON <input type="radio"/> OFF			
Routing Range	<input type="text" value="0"/> to <input type="text" value="49"/> (0~49)		
CODEC Tx Gain:	<input type="text" value="6"/> (0~7)	CODEC Rx Gain:	<input type="text" value="6"/> (0~7)
SIP From:	Tel/User (Standard) <input type="button" value="v"/>	Answer Delay	<input type="text" value="0"/> (0~15)
CLID Presentation	<input type="radio"/> Suppression <input checked="" type="radio"/> Invocation		

These settings seem to be ok, just adjust ...

20.3 Antenna position

Another important thing is to properly place the provided antenna.

If your gsm reception is good, you should get around 18 or 19 as Signal Quality in the "Mobile Status" page.

With that level of signal quality, your audio quality will be very good.

On the other end, the signal quality down to 11, audio becomes very jerky. So, maximum signal quality = maximum audio quality.

20.4 Asterisk configuration

Once the MV-372 is set, you have to configure Asterisk.

On that side, you have to setup files as follow :

20.5 sip.conf

```
; GSM VOIP Gateway MV-372  
[103]  
type=friend
```

```
username=103
fromuser=103
regexten=103 ; When they register, create extension 401
secret=xxxxxxx ; Asterisk extension password
context=gateway ; Incoming calls context
dtmfmode=inband ; Very important for DISA to work
call-limit=1 ; Limit to 1 call max
callerid=GSM Gateway <103>
host=dynamic
nat=no ; Gateway is not behind a NAT router
canreinvite=no ; Typically set to NO if behind NAT
insecure=very
qualify=yes
disallow=all
allow=ulaw ; preferred codec for DTMF detection
allow=alaw
```

20.6 extensions.conf

```
; ***** GSM Gateway incoming calls *****
[gateway]
exten => _103,1,Answer()
exten => _103,2,DigitTimeout(3) ; give enough time to do second stage
dialing
exten => _103,3,ResponseTimeout(5)
exten => _103,4,DISA(no-password|outgoing) ; here 'outgoing' is the
normal context to deal with the dial plan

[outgoing]
...
; example of LAN to GSM call
; call the MV-372 sim card mail box thru GSM
exten => _888,1,SetCallerID("xxxxxxxxxx")
exten => _888,2,Dial(SIP/${EXTEN}@103,60,r)
exten => _888,3,Hangup()
```

21. How to setup Asterisk to receive Caller ID from MV-372

Test version

trixbox-2.2

SIP Softphone

- SJPhone 1.60.289a
- X-Lite 1105x

Modify file

- Add the following setting to /etc/asterisk/sip.conf

[1000]

type=friend

secret=1000

qualify=yes

nat=yes

host=dynamic

canreinvite=no

context=internal

[1001]

type=friend

secret=1001

qualify=yes

nat=yes

host=dynamic

canreinvite=no

context=internal

[1002]

type=friend

secret=1002

qualify=yes

nat=yes
host=dynamic
canreinvite=no
context=internal

- Add the following setting to /etc/asterisk/extensions.conf

```
[internal]  
exten => 1000,1,Dial(SIP/1000)  
exten => 1001,1,Dial(SIP/1001)  
exten => 1002,1,Dial(SIP/1002)
```

configure:

trixbox-2.2: address=192.168.66.202:5060

SJPhone: address=192.168.66.145:5060; username=1000,
displayname=user_1000

X-Lite: address=192.168.66.145:7331; username=1001, displayname=user_1001

MV-372: address=192.168.66.203:5060; username=1002, displayname=user_1002

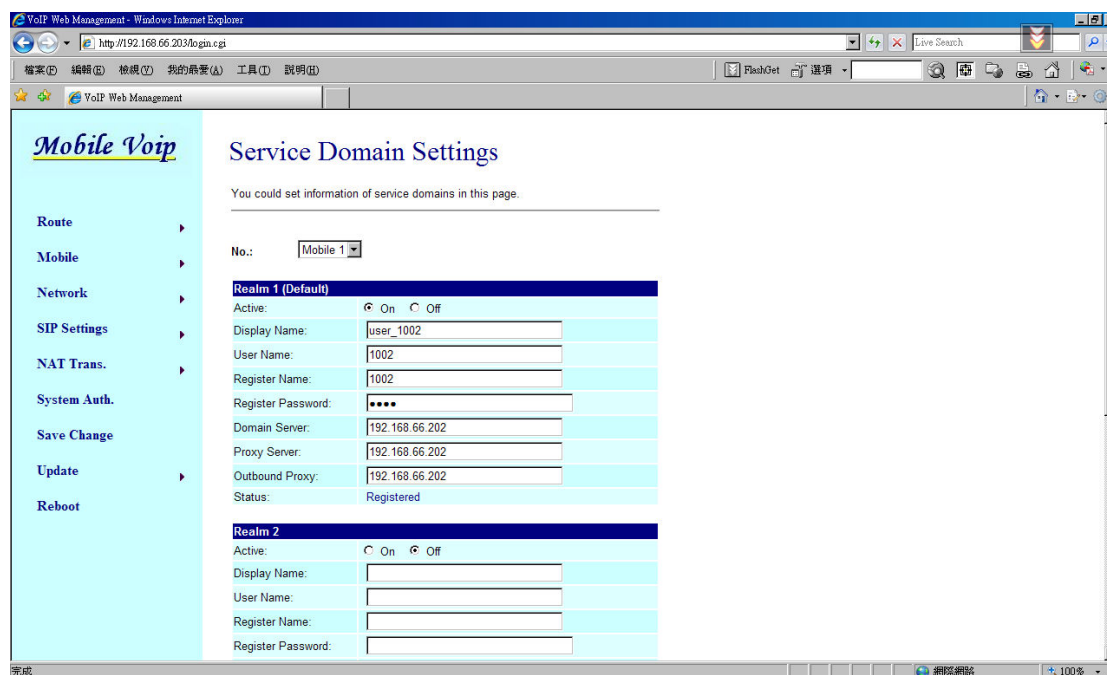

test1

pstn → call 0928492911(mobile number) → MV-372 → hear the second dial tone, call
SoftPhone's number → SoftPhone → show pstn caller id

This Is X-Lite receiving packet, red word is pstn number. Test ok.

```
INVITE sip:1001@192.168.66.145:7331 SIP/2.0
Via: SIP/2.0/UDP 192.168.66.202:5060;branch=z9hG4bK3d0bbaf7;rport
From: "035678238" <sip:1002@192.168.66.202>;tag=as580472a7
To: <sip:1001@192.168.66.145:7331>
Contact: <sip:1002@192.168.66.202>
Call-ID: 20fa417265e6a26d0b0aae4f551f06f3@192.168.66.202
CSeq: 102 INVITE
User-Agent: Asterisk PBX
Max-Forwards: 70
Date: Tue, 22 May 2007 02:50:37 GMT
Allow: INVITE, ACK, CANCEL, OPTIONS, BYE, REFER, SUBSCRIBE, NOTIFY
Content-Type: application/sdp
Content-Length: 242
```

```
v=0
o=root 2737 2737 IN IP4 192.168.66.202
s=session
c=IN IP4 192.168.66.202
t=0 0
m=audio 15852 RTP/AVP 0 8 101
a=rtpmap:0 PCMU/8000
a=rtpmap:8 PCMA/8000
a=rtpmap:101 telephone-event/8000
a=fmtp:101 0-16
a=silenceSupp:off - - - -
```

SIP/2.0 200 Ok

Via: SIP/2.0/UDP 192.168.66.202:5060;branch=z9hG4bK3d0bbaf7;rport

From: "035678238" <sip:1002@192.168.66.202>;tag=as580472a7

To: <sip:1001@192.168.66.145:7331>;tag=677373503

Contact: <sip:1001@192.168.66.145:7331>

Call-ID: 20fa417265e6a26d0b0aae4f551f06f3@192.168.66.202

CSeq: 102 INVITE

Content-Type: application/sdp

Server: X-Lite release 1105x

Content-Length: 254

v=0

o=1001 4804366 4807851 IN IP4 192.168.66.145

s=X-Lite

c=IN IP4 192.168.66.145

t=0 0

m=audio 8000 RTP/AVP 0 8 3 101

a=rtpmap:0 pcmu/8000

a=rtpmap:8 pcma/8000

a=rtpmap:3 gsm/8000

a=rtpmap:101 telephone-event/8000

a=fmtp:101 0-15

a=sendrecv

test 2

SoftPhone → call 1002 → MV-372 → hear second dial tone and call pstn → pstn
answer → show caller id-mobile number 0928492911

This Is X-Lite receiving packet. Test ok.

INVITE sip:1002@192.168.66.202 SIP/2.0

Via: SIP/2.0/UDP
192.168.66.145:7331;rport;branch=z9hG4bK4C4315351FC84CA582D14FB8C25F
C3BF
From: user_1001 <sip:1001@192.168.66.202:7331>;tag=1121869743
To: <sip:1002@192.168.66.202>
Contact: <sip:1001@192.168.66.145:7331>
Call-ID: F4B32CA6-1835-4E68-941A-C685B39C43FF@192.168.66.145
CSeq: 63148 INVITE
Proxy-Authorization: Digest
username="1001",realm="asterisk",nonce="0d3b2879",response="8aaaaa5b5ad53
654bf0a2ab0fa9bb118",uri="sip:1002@192.168.66.202",algorithm=MD5
Max-Forwards: 70
Content-Type: application/sdp
User-Agent: X-Lite release 1105x
Content-Length: 254

v=0
o=1001 5111461 5111501 IN IP4 192.168.66.145
s=X-Lite
c=IN IP4 192.168.66.145
t=0 0
m=audio 8000 RTP/AVP 0 8 3 101
a=rtpmap:0 pcmu/8000
a=rtpmap:8 pcma/8000
a=rtpmap:3 gsm/8000
a=rtpmap:101 telephone-event/8000
a=fmtp:101 0-15
a=sendrecv

SIP/2.0 200 OK
Via: SIP/2.0/UDP
192.168.66.145:7331;branch=z9hG4bK4C4315351FC84CA582D14FB8C25FC3BF
;received=192.168.66.145;rport=7331

From: user_1001 <sip:1001@192.168.66.202:7331>;tag=1121869743
To: <sip:1002@192.168.66.202>;tag=as2a2fbf98
Call-ID: F4B32CA6-1835-4E68-941A-C685B39C43FF@192.168.66.145
CSeq: 63148 INVITE
User-Agent: Asterisk PBX
Allow: INVITE, ACK, CANCEL, OPTIONS, BYE, REFER, SUBSCRIBE, NOTIFY
Contact: <sip:1002@192.168.66.202>
Content-Type: application/sdp
Content-Length: 242

v=0
o=root 2737 2737 IN IP4 192.168.66.202
s=session
c=IN IP4 192.168.66.202
t=0 0
m=audio 13798 RTP/AVP 0 8 101
a=rtpmap:0 PCMU/8000
a=rtpmap:8 PCMA/8000
a=rtpmap:101 telephone-event/8000
a=fmtp:101 0-16
a=silenceSupp:off - - - -

register issue

The packet data from Asterisk as follows.
Please note, user_1002's display name don't appear
So the website's Display Name is not available

<-- SIP read from 192.168.66.203:5060:
REGISTER sip:192.168.66.202 SIP/2.0
Via: SIP/2.0/UDP
192.168.66.203:5060;rport;branch=z9hG4bK590e92b551233a10a0ae71944c19b5
aa
From: <sip:1002@192.168.66.202>;tag=4e36d8f1

To: <sip:1002@192.168.66.202>
Call-ID: 7e45b773130f1fc945efcee502f84042@192.168.66.203
Contact: <sip:1002@192.168.66.203:5060>
CSeq: 10 REGISTER
Expires: 300
Authorization: Digest
username="1002",realm="asterisk",nonce="3ca93a1e",response="4d39ccb0dae64
bb2f1341e9896ac1ea7",uri="sip:192.168.66.202",algorithm=MD5
User-Agent: CMI CM5K
Content-Length: 0

--- (11 headers 0 lines) ---

Using latest REGISTER request as basis request
Sending to 192.168.66.203 : 5060 (NAT)
Transmitting (NAT) to 192.168.66.203:5060:
SIP/2.0 100 Trying
Via: SIP/2.0/UDP
192.168.66.203:5060;branch=z9hG4bK590e92b551233a10a0ae71944c19b5aa;rec
eived=192.168.66.203;rport=5060
From: <sip:1002@192.168.66.202>;tag=4e36d8f1
To: <sip:1002@192.168.66.202>
Call-ID: 7e45b773130f1fc945efcee502f84042@192.168.66.203
CSeq: 10 REGISTER
User-Agent: Asterisk PBX
Allow: INVITE, ACK, CANCEL, OPTIONS, BYE, REFER, SUBSCRIBE, NOTIFY
Contact: <sip:1002@192.168.66.202>
Content-Length: 0

Transmitting (NAT) to 192.168.66.203:5060:
SIP/2.0 401 Unauthorized

Via: SIP/2.0/UDP
192.168.66.203:5060;branch=z9hG4bK590e92b551233a10a0ae71944c19b5aa;received=192.168.66.203;rport=5060
From: <sip:1002@192.168.66.202>;tag=4e36d8f1
To: <sip:1002@192.168.66.202>;tag=as13a32ae8
Call-ID: 7e45b773130f1fc945efcee502f84042@192.168.66.203
CSeq: 10 REGISTER
User-Agent: Asterisk PBX
Allow: INVITE, ACK, CANCEL, OPTIONS, BYE, REFER, SUBSCRIBE, NOTIFY
WWW-Authenticate: Digest algorithm=MD5, realm="asterisk", nonce="5def9231"
Content-Length: 0

Scheduling destruction of call
'7e45b773130f1fc945efcee502f84042@192.168.66.203' in 15000 ms
asterisk1*CLI>
<-- SIP read from 192.168.66.203:5060:
REGISTER sip:192.168.66.202 SIP/2.0
Via: SIP/2.0/UDP
192.168.66.203:5060;rport;branch=z9hG4bK672fa67f59c2223275f5ee286d27597a
From: <sip:1002@192.168.66.202>;tag=4e36d8f1
To: <sip:1002@192.168.66.202>
Call-ID: 7e45b773130f1fc945efcee502f84042@192.168.66.203
Contact: <sip:1002@192.168.66.203:5060>
CSeq: 11 REGISTER
Expires: 300
Authorization: Digest
username="1002",realm="asterisk",nonce="5def9231",response="046a412f4e7ed4e98fd507416994a80a",uri="sip:192.168.66.202",algorithm=MD5
User-Agent: CMI CM5K
Content-Length: 0

--- (11 headers 0 lines) ---

Using latest REGISTER request as basis request

Sending to 192.168.66.203 : 5060 (NAT)

Transmitting (NAT) to 192.168.66.203:5060:

SIP/2.0 100 Trying

Via: SIP/2.0/UDP

192.168.66.203:5060;branch=z9hG4bK672fa67f59c2223275f5ee286d27597a;received=192.168.66.203;rport=5060

From: <sip:1002@192.168.66.202>;tag=4e36d8f1

To: <sip:1002@192.168.66.202>

Call-ID: 7e45b773130f1fc945efcee502f84042@192.168.66.203

CSeq: 11 REGISTER

User-Agent: Asterisk PBX

Allow: INVITE, ACK, CANCEL, OPTIONS, BYE, REFER, SUBSCRIBE, NOTIFY

Contact: <sip:1002@192.168.66.202>

Content-Length: 0

12 headers, 0 lines

Reliably Transmitting (NAT) to 192.168.66.203:5060:

OPTIONS sip:1002@192.168.66.203:5060 SIP/2.0

Via: SIP/2.0/UDP 192.168.66.202:5060;branch=z9hG4bK7b92dd8a;rport

From: "Unknown" <sip:Unknown@192.168.66.202>;tag=as5dee3942

To: <sip:1002@192.168.66.203:5060>

Contact: <sip:Unknown@192.168.66.202>

Call-ID: 5ebc2211278e2cb7699911ad39454d4e@192.168.66.202

CSeq: 102 OPTIONS

User-Agent: Asterisk PBX

Max-Forwards: 70

Date: Tue, 22 May 2007 03:11:54 GMT

Allow: INVITE, ACK, CANCEL, OPTIONS, BYE, REFER, SUBSCRIBE, NOTIFY

Content-Length: 0

Transmitting (NAT) to 192.168.66.203:5060:

SIP/2.0 200 OK

Via: SIP/2.0/UDP

192.168.66.203:5060;branch=z9hG4bK672fa67f59c2223275f5ee286d27597a;received=192.168.66.203;rport=5060

From: <sip:1002@192.168.66.202>;tag=4e36d8f1

To: <sip:1002@192.168.66.202>;tag=as13a32ae8

Call-ID: 7e45b773130f1fc945efcee502f84042@192.168.66.203

CSeq: 11 REGISTER

User-Agent: Asterisk PBX

Allow: INVITE, ACK, CANCEL, OPTIONS, BYE, REFER, SUBSCRIBE, NOTIFY

Expires: 300

Contact: <sip:1002@192.168.66.203:5060>;expires=300

Date: Tue, 22 May 2007 03:11:54 GMT

Content-Length: 0

22. Simple Steps

Step 1. Change the Network setting if you need (Network/network setting)

Step 2. Register SIP proxy Server or Asterisk or VoipBuster if you need
(sip setting/service domain)

Step 3. Set Route (**request**)

mobile to lan:	
(1)	*,* --->it is two stage dialing.
	when mobile call in,MV-372 will provide dial tone and you can enter ip or asterisk extension or phone number.
*	If you want to enter phone number,please note your asterisk need to have route of destination number.
(2)	*, specific extension or IP or phone number
	when mobile call in,MV-372 will connect with this specific extension or IP or phone number auto
*	If you want to set specific phone number,please note your asterisk need to have route of destination number.
Lan to Mobile:	
(1)	*,* --->it is two stage dialing.
	when lan phone call in,MV-372 will provide dial tone and you can enter mobile number.
(2)	*, specific mobile number
	when lan phone call in,MV-372 will connect with the specific mobile number auto.
(3)	*,#--->It is 1 stage dialing
	When lan phone and MV-372 both register Asterisk, you can dial any destination number from lan phone directly.
*	Please note:Asterisk need to set route of destination number that dial out from MV-372

* All changes both need to click "save and change"

